

sustainability

Special Issue

**New Studies in EROI
(Energy Return on Investment)**

2011

Charles A.S. Hall and Doug Hansen (Eds.)



External Editors

Editor-in-Chief

Prof. Dr. Marc A. Rosen
Faculty of Engineering and Applied Science
University of Ontario Institute of Technology
2000 Simcoe Street North
Oshawa, Ontario, L1H 7K4, Canada
Phone: +1 905 721 8668, ext 5726
Fax: +1 905 721 3370
Website: <http://www.engineering.uoit.ca/people/rosen>
E-Mail: marc.rosen@uoit.ca

Guest Editor

Prof. Dr. Charles A.S. Hall
Faculty of Environmental & Forest Biology
College of Environmental Science & Forestry
State University of New York
354 Illick Hall
1 Forestry Drive
Syracuse, New York 13210, USA
Phone: +1 315 470 6870
Fax: +1 315 470 6934
Website: <http://www.esf.edu/EFB/hall/>
E-Mail: chall@esf.edu

Associate Editor

Mr. Doug Hansen
Hansen Financial Management
12717 Monterey Cypress Way
San Diego, CA 92130, USA
E-Mail: doug6636@gmail.com

Editorial Office

MDPI AG
Kandererstrasse 25
Basel, Switzerland
Phone: +41 61 683 77 34
Website: <http://www.mdpi.com/journal/sustainability/>
E-Mail: sustainability@mdpi.com

Publisher

Dr. Shu-Kun Lin

Production Editor

Dr. Brietta Pike

Managing Editor

Dr. Jose A.F. Monteiro

Cover picture:

Ekofisk oil field in the Norwegian sector of the North Sea.

Author: unknown

Available online at:

no.wikipedia.org/wiki/Fil:Ekofisk_complex.jpg

ISBN: 3-906980-31-6

Table of Contents

Part I: Conceptual Issues

Editorial

Introduction to Special Issue on New Studies in EROI (Energy Return on Investment)

Charles A.S. Hall,
Sustainability **2011**, 3, 1773-1777; doi:10.3390/su3101773 2

Article

Order from Chaos: A Preliminary Protocol for Determining the EROI of Fuels

David J. Murphy, Charles A.S. Hall, Michael Dale and Cutler Cleveland,
Sustainability **2011**, 3, 1888-1907; doi:10.3390/su3101888 7

Review

A Review of the Past and Current State of EROI Data

Ajay K. Gupta and Charles A.S. Hall,
Sustainability **2011**, 3, 1796-1809; doi:10.3390/su3101796 27

Article

A Dynamic Function for Energy Return on Investment

Michael Dale, Susan Krumdieck and Pat Bodger,
Sustainability **2011**, 3, 1972-1985; doi:10.3390/su3101972 41

Article

System Energy Assessment (SEA), Defining a Standard Measure of EROI for Energy Businesses as Whole Systems

Philip F. Henshaw, Carey King and Jay Zarnikau,
Sustainability **2011**, 3, 1908-1943; doi:10.3390/su3101908 55

Article

Relating Financial and Energy Return on Investment

Carey W. King and Charles A.S. Hall,
Sustainability **2011**, 3, 1810-1832; doi:10.3390/su3101810 91

Part II: EROI for Conventional Fossil Fuels

Article

A New Long Term Assessment of Energy Return on Investment (EROI) for U.S. Oil and Gas Discovery and Production

Megan C. Guilford, Charles A.S. Hall, Peter O'Connor and Cutler J. Cleveland,
Sustainability **2011**, 3, 1866-1887; doi:10.3390/su3101866 115

Article

Energy Return on Investment for Norwegian Oil and Gas from 1991 to 2008

Leena Grandell, Charles A.S. Hall and Mikael Höök,
Sustainability **2011**, 3, 2050-2070; doi:10.3390/su3112050 137

Article

Oil Depletion and the Energy Efficiency of Oil Production: The Case of California

Adam R. Brandt,
Sustainability **2011**, 3, 1833-1854; doi:10.3390/su3101833 158

Article

Analysis of the Energy Return on Investment (EROI) of the Huge Daqing Oil Field in China

Yan Hu, Lianyong Feng, Charles C.S. Hall and Dong Tian,
Sustainability **2011**, 3, 2323-2338; doi:10.3390/su3122323 180

Article

The EROI of Conventional Canadian Natural Gas Production

Jon Freise,
Sustainability **2011**, 3, 2080-2104; doi:10.3390/su3112080 196

Article

Energy Return on Energy Invested for Tight Gas Wells in the Appalachian Basin, United States of America

Bryan Sell, David Murphy and Charles A.S. Hall,
Sustainability **2011**, 3, 1986-2008; doi:10.3390/su3101986 221

Article

Ultra-Deepwater Gulf of Mexico Oil and Gas: Energy Return on Financial Investment and a Preliminary Assessment of Energy Return on Energy Investment

Matthew Moerschbaeher and John W. Day Jr.,
Sustainability **2011**, 3, 2009-2026; doi:10.3390/su3102009 244

Part III: EROI for Other Fuels

Review

Seeking to Understand the Reasons for Different Energy Return on Investment (EROI) Estimates for Biofuels

Charles A.S. Hall, Bruce E. Dale and David Pimentel,
Sustainability **2011**, 3, 2413-2432; doi:10.3390/su3122413 263

Article

Energy Return on Investment (EROI) of Oil Shale

Cutler J. Cleveland and Peter A. O'Connor,

Sustainability **2011**, 3, 2307-2322; doi:10.3390/su3112307 283

Article

An Edible Energy Return on Investment (EEROI) Analysis of Wheat and Rice in Pakistan

Ali S. Pracha and Timothy A. Volk,

Sustainability **2011**, 3, 2358-2391; doi:10.3390/su3122358 299

Article

Energy Return on Energy Invested (EROI) for the Electrical Heating of Methane Hydrate Reservoirs

Roberto Cesare Callarotti,

Sustainability **2011**, 3, 2105-2114; doi:10.3390/su3112105 333

Part IV: Looking Forward

Article

Predicting the Psychological Response of the American People to Oil Depletion and Declining Energy Return on Investment (EROI)

Jessica G. Lambert and Gail P. Lambert,

Sustainability **2011**, 3, 2129-2156; doi:10.3390/su3112129 344

Article

Implications of Energy Return on Energy Invested on Future Total Energy Demand

Shinuo Deng and George R. Tynan,

Sustainability **2011**, 3, 2433-2442; doi:10.3390/su3122433 372

Article

Deriving an Improved Dynamic EROI to Provide Better Information for Energy Planners

Ioannis N. Kessides and David C. Wade,

Sustainability **2011**, 3, 2339-2357; doi:10.3390/su3122339 382

Article

Looking for a Silver Lining: The Possible Positives of Declining Energy Return on Investment (EROI)

Jack P. Manno,

Sustainability **2011**, 3, 2071-2079; doi:10.3390/su3112071 401

Editorial

Synthesis to Special Issue on New Studies in EROI (Energy Return on Investment)

Charles A.S. Hall,

Sustainability **2011**, 3, 2496-2499; doi:10.3390/su3122496 410

Part I: Conceptual Issues

Editorial

Introduction to Special Issue on New Studies in EROI (Energy Return on Investment)

Charles A.S. Hall

Departments of Environmental and Forest Biology and Environmental Studies, and Graduate Program in Environmental Science, College of Environmental Science and Forestry, State University of New York Syracuse, New York, NY 13210, USA; E-Mail: chall@esf.edu; Tel.: +1-315-470-6870; Fax: +1-315 470 6954

Received: 10 August 2011 / Accepted: 17 August 2011 / Published: 7 October 2011

Abstract: Energy Return on Investment (EROI) refers to how much energy is returned from one unit of energy invested in an energy-producing activity. It is a critical parameter for understanding and ranking different fuels. There were a number of studies on EROI three decades ago but relatively little work since. Now there is a whole new interest in EROI as fuels get increasingly expensive and as we attempt to weigh alternative energies against traditional ones. This special volume brings together a whole series of high quality new studies on EROI, as well as many papers that struggle with the meaning of changing EROI and its impact on our economy. One overall conclusion is that the quality of fuels is at least as important in our assessment as is the quantity. I argue that many of the contemporary changes in our economy are related directly to changing EROI as our premium fuels are increasingly depleted.

Keywords: energy; EROI; economic; fuels; quality of fuels

The concept of Energy Return on Investment (EROI) is a concept originally derived in ecology but increasingly applied to oil and other industrial energies. It had precedents in the idea of “net energy analysis” used by Leslie White, Kenneth Boulding and especially Howard Odum [1,2]. Similar but less explicit and focused ideas can be found in the newer field of “life cycle analysis” that is better developed in Europe than in the US. The word investment usually means *energy* investment but sometimes may also include *financial*, *environmental* and/or other kinds of investments. Some people like the term EROEI as a more explicit term, but we find it less useful and harder to pronounce. The term EROI has been around since at least 1970, but it gained relatively little traction until the last five

or ten years. Now there is an explosion of interest as peak oil and the general economic effects of increasingly constrained energy supplies are becoming obvious to investigators from many fields. This special issue examines various aspects of EROI with many exciting new studies from all around the world. It is very special as there had been almost no new studies since the original studies of the 1970s and 1980s and as the critical importance of the concept becomes ever more apparent as our highest quality fuels are increasingly depleted.

There have been questions about the degree to which we should use EROI vs. more familiar ways (e.g., price, financial return on financial investment in the oil business) to examine energy and other resource choices. In addition there have been criticisms that EROI has some severe flaws: that different studies give different answers to what appears to be the same question, that the boundaries of the analysis are controversial, that market pricing is always superior to scientific studies, and that EROI too often is dependent upon monetary data for its results. Explicit arguments for the virtues of EROI are found in the Murphy *et al.* protocol paper in this issue [3]. Many other papers in this volume take on these issues directly, often through sensitivity analysis, and we believe that the papers collectively make the case that EROI is an incredibly robust, useful and interesting tool. While we embrace “methodological pluralism”, that is different approaches to analysis, we favor EROI as the most basic and useful kind of analysis for examining and perhaps determining our energy future because, as developed by King and Hall in this issue, it ultimately determines the other ratios [4].

All of the papers in this special issue have been peer reviewed, usually very thoroughly, by appropriate professionals. Several papers did not make it through the review process. Several of the papers that did were nevertheless controversial, to say the least, and as editor of the whole issue I was faced with several situations where I had both strongly positive and strongly negative reviews. In that situation I sought additional reviewers, and generally received again mixed reviews. Where there were a balanced number of positive and negative reviews I chose to publish the papers as I thought they tended to be papers that I felt raised new and or important issues that later research is likely to sort out.

The issue is divided into four basic sections: Conceptual issues, EROI for Conventional fossil fuels, EROI for other fuels, and looking forward.

In my opinion this is a remarkably important group of papers. While EROI has yet to gain global popularity most of the contributors to this special issue would probably agree that few issues are likely to be more important for the future of civilization, whatever that might be. For many of us the financial crises that we have been experiencing since 2008 is a direct effect of the cessation of the growth of oil (and even of all liquid fuels if done on an energy, not volume, basis) and of the general decline in EROI. While this is not to discount the role of greed, corruption and mismanagement in all things financial, nor the enormous shift in wealth to the upper few percent over the past several decades, at the root of it all lies the decline in cheap, high EROI fuel that had once allowed the economy to do more work. This has been especially important as the economy has been shifting to higher labor productivity, meaning that each worker generates more value added per hour working. While increasing labor productivity is normally perceived as a good thing higher productivity is usually obtained by subsidizing each hour worked with increasing fossil fuel—in effect making each worker more productive but each unit of energy less productive than otherwise because there is less labor behind it! One result is that when Federal money is used to try to create jobs the money goes increasingly to energy, even energy from overseas, rather than salaries.

The net effect of decreasing net energy supplies coupled with increasing labor productivity is that 10 to 20 percent of Americans have no job at all, a poorly paying job in the service sector, or work part time. Incomes for the middle class have been stagnant at best for decades while the size of the middle class shrinks. Many, perhaps most, new college graduates have had to greatly reduce their aspirations. The stock market and real estate have become far less reliable ways to amass wealth. Some 46 of our 50 states and many of our municipalities face crippling budget deficits, and many colleges, pension plans, charities and other institutions are operating with diminished funds or going bankrupt. It is increasingly difficult to pay for the repair of storms and other environmental disasters. Even the United States Government has seen its credit rating diminished. “Tea Partiers” seek to cut debt and the role of government even while pole after pole shows the public does not want its health care or most other benefits cut. Keynesian deficit spending that worked in the past and might work again has few advocates today because of crippling debt, nor is there the likelihood of future growth to repay any such deficit spending because, unlike in 1946, the possibilities biophysical constraints make the potential for sustained economic expansion seem very thin indeed. As individuals and as a nation we have been living beyond our energy means for decades. We collectively do not know how to change that situation because tax increases have become so unpopular even while such previously unheard of programs as Medicare have become sacred. In earlier times the growth of the economic pie defused arguments about how to cut it, but now the growth of the pie, constrained by the end of cheap energy and the demise of energy growth, seems much less likely.

If the pie is no longer getting larger, indeed if because of energy constraints it can no longer get larger, how will we slice it? This may force some ugly debates back into the public vision. Indeed if EROI continues to decline then that will cut increasingly into discretionary spending (the engine for economic growth) and we will need to ask some very hard questions about how we should spend our money. One way to think about this is “Maslow’s hierarchy of human needs” [5]. This theory, proposed by Abraham Maslow in his 1943 paper “A Theory of Human Motivation”, proposes that humans will attempt to meet their needs in more or less the following order: First they will meet their physiological needs, which are the literal requirements for human survival, including breathing, nutrition, water, sleep, homeostasis, excretion and reproductive activity. Second, once physiological needs are satisfied an individual will attempt to meet safety needs in an attempt to attain a predictable, orderly world in which perceived unfairness and inconsistency are under control, the familiar frequent and the unfamiliar rare. Third, once the above needs are met humans seek love and belonging, *i.e.*, emotionally based relationships in general, such as friendship, intimacy and family. Fourth, again once the above have been met humans seek esteem, to be respected and to have self-esteem and self-respect and also the esteem of others. Finally, according to Maslow, people seek self-actualization, the need to understand what a person’s full potential is and to realize that potential, to become everything that one is capable of becoming—for example an ideal parent, athlete, painter, or inventor.

Such a hierarchy applies to our energy use. Think of a society dependent upon one resource: its domestic oil. If the EROI for this oil was 1.1:1 then one could pump the oil out of the ground and look at it. If it were 1.2:1 you could also refine it and look at it, 1.3:1 also distribute it to where you want to use it but all you could do is look at it. Hall *et al.* 2008 examined the EROI required to actually run a truck and found that if the energy included was enough to build and maintain the truck and the roads and bridges required to use it (*i.e.*, depreciation), one would need at least a 3:1 EROI at the

wellhead [6]. Now if you wanted to put something in the truck, say some grain, and deliver it that would require an EROI of, say, 5:1 to grow the grain. If you wanted to include depreciation on the oil field worker, the refinery worker, the truck driver and the farmer you would need an EROI of say 7 or 8:1 to support the families. If the children were to be educated you would need perhaps 9 or 10:1, have health care 12:1, have arts in their life maybe 14:1 and so on. Obviously to have a modern civilization one needs not simply surplus energy but lots of it, and that requires either a high EROI or a massive source of moderate EROI fuels. As we watch the magnificent Syracuse Symphony and our equally magnificent State University systems go broke we believe we are watching the beginning of the decline of civilization driven by a declining EROI. If things get a lot tougher, as many think, the low EROI energy that is available will go to growing food and supporting families. It is clear that we must understand energy and its changes if we are to understand changes in our economy.

Maslow's theory has been criticized from a number of angles including the supposed lack of evidence that humans in fact follow that hierarchy, or indeed any such hierarchy, and from the perspective that his "pyramids of needs" may be more representative of people from an individualist vs. socialist society. Nevertheless his theory is broadly accepted in psychology and even marketing. Our own research on the implications of declining net energy, while not consciously based on Maslow's theories, is consistent with them. We have the sense that discretionary spending will be increasingly abandoned as humans attempt to meet their basic needs for food, shelter and clothing [7]. Presumably as the amount of net energy declines due to peak oil and declining EROI, humans will increasingly give up categories higher on the pyramids and concentrate increasingly on the more basic requirements including food, shelter and clothing. What this may mean in modern society is that performance art, then expensive vacations, then education, then health care would be abandoned by the middle class as the economy is increasingly restricted. Whether this can be reversed by diverting where and by whom we chose to spend such surplus money or energy as we have will be an increasingly dominant challenge to society.

Acknowledgments

I thank all authors and reviewers for this special issue, and Ajay Gupta and Alexandre Poisson for editorial help on this chapter.

Conflict of Interest

There are no conflicts of interest associated with this paper.

References and Notes

1. Odum, H.T. *Environment, Power and Society*. Wiley Interscience: New York, NY, USA, 1973.
2. Odum, H.T. Energy, ecology and economics. *AMBIO* **1973**, *2*, 220-227.
3. Murphy, D.; Hall C.A.S., Dale M.; Cleveland, C. Order from chaos: A preliminary protocol for determining EROI for fuels. *Sustainability*, in press.
4. King, C.; Hall, C.A.S. Relating financial and energy return on investment. *Sustainability*, in press.
5. Maslow, A. A theory of human motivation. *Psychological Review* **1943**, *50*, 370-396.

Sustainability **2011**, *3*

6. Hall, C.A.S.; Balogh, S.; Murphy, D.J. What is the minimum EROI that a sustainable society must have? *Energies* **2009**, *2*, 25-47.
7. Hall, C.A.S.; Klitgaard; K. *Energy and the Wealth of Nations: Understanding the Biophysical Economy*. Springer: New York, NY, USA, 2011.

© 2011 by the authors; licensee MDPI, Basel, Switzerland. This article is an open access article distributed under the terms and conditions of the Creative Commons Attribution license (<http://creativecommons.org/licenses/by/3.0/>).

Article

Order from Chaos: A Preliminary Protocol for Determining the EROI of Fuels

David J. Murphy ^{1,*}, Charles A.S. Hall ², Michael Dale ³ and Cutler Cleveland ⁴

¹ Department of Geography and the Institute for the Study of the Environment, Sustainability, and Energy, Northern Illinois University, Dekalb, IL 60115, USA; E-Mail: djmurphy@niu.edu

² Department of Environmental and Forest Biology and the Program in Environmental Science, College of Environmental Science and Forestry, Syracuse, NY 13210, USA; E-Mail: chall@esf.edu

³ Global Climate and Energy Project (GCEP), Stanford University, Palo Alto, CA 94305, USA; E-Mail: mikdale@stanford.edu

⁴ Geography and Environment, Boston University, Boston MA 02215, USA; E-Mail: cutler@bu.edu

* Author to whom correspondence should be addressed; E-Mail: djmurphy@niu.edu; Tel.: +1-815-753-6834, Fax: +1-815-753-6872.

Received: 28 July 2011; in revised form: 1 August 2011 / Accepted: 5 August 2011 /

Published: 17 October 2011

Abstract: The main objective of this manuscript is to provide a formal methodology, structure, and nomenclature for EROI analysis that is both consistent, so that all EROI numbers across various processes can be compared, and also flexible, so that changes or additions to the universal formula can focus analyses on specific areas of concern. To accomplish this objective we address four areas that are of particular interest within EROI analysis: (1) boundaries of the system under analysis, (2) energy quality corrections, (3) energy-economic conversions, and (4) alternative EROI statistics. Lastly, we present step-by-step instructions outlining how to perform an EROI analysis.

Keywords: energy; EROI; protocol; boundaries; energy quality; economics

1. Introduction

As concerns about the prices and the future availability of oil have once again arisen, various alternatives have been put forth as potential substitutes for oil. Many economists argue that “the end of cheap oil” is not particularly worrisome because market forces will ameliorate the effects of oil depletion by generating large quantities of additional petroleum from lower grade resources and by developing substitutes for that oil [1,2]. Others believe that oil is a high quality one-time resource for which no adequate alternative is available [3,4]. Much of the debate about oil and its potential substitutes has centered on the concepts of the “net energy” and “energy return on investment” (EROI) delivered by oil and its alternatives. While this should be a relatively straightforward approach to informing the debate, with a clear, quantitative rationale for resolving or ranking alternatives, the literature to date is in fact confusing, divergent, and often acrimonious.

Nonetheless, there are a number of potential benefits that proper EROI analysis can provide:

- (1) First, much like economic cost-benefit analysis, EROI analysis can provide a numerical output that can be compared easily with other similar calculations. For example, the EROI of oil (and hence gasoline) is currently between about 10:1 and 20:1, whereas that for corn-based ethanol is below 2:1 [5-8]. Using this perspective it is easy to see that substituting ethanol for gasoline would have significant energy, economic and environmental implications since the same energy investment into gasoline yields at least a fivefold greater energy return (with a correspondingly lower impact per unit delivered to society) than that from ethanol.
- (2) Second, EROI is a useful measure of resource quality. Here quality is defined as the ability of a heat unit to generate economic output [9]. High EROI resources are considered to be, *ceteris paribus*, more useful than resources with low EROIs. If EROI declines over time more of society’s total economic activity goes just to get the energy to run the rest of the economy, and less useful economic work (i.e. producing desirable goods and services) is done.
- (3) Third, using EROI measurements in conjunction with standard measures of the magnitude of energy resources provides additional insight about the total net energy gains from an energy resource. For example, the oil sands of Canada present a vast resource base, roughly 170 billion barrels of recoverable crude oil, yet the EROI of this resource is presently about 3:1 on average, indicating that only three quarters of the 170 billion barrels of recoverable oil will represent net energy (*i.e.*, energy remaining after accounting for the extraction cost, see [10]).
- (4) Fourth, creating time-series data sets of EROI measurements for a particular resource provides insight as to how the quality of a resource base is changing over time. For example, the EROI of US and presumably global oil production generally increased during the first half of the 20th Century and has declined since (see Guilford *et al.* [11], this Special Issue). The decrease in EROI indicates that the quality of the resource base is also declining, *i.e.*, either the investment energy used in extraction has increased without a commensurate increase in energy output, or the energy gains from extraction have decreased [12]. It also gives a means of examining the relative impacts of technology *vs.* depletion. If the EROI is declining presumably depletion is more important than technological change.

In order to take advantage of these benefits, the method of calculating EROI must have two, somewhat contradictory, attributes; consistency and flexibility. The methodology must be consistent so that researchers can replicate calculations accurately, yet flexible so that meaningful comparisons can be made across disparate energy extraction or conversion pathways. These may or may not involve multiple types of energy inputs or outputs and/or technologies. As the introductory chapter to this special issue dedicated to EROI, our main objective is to provide a formal methodology, structure, and nomenclature for EROI analysis that will serve both of these roles. We do this by addressing four areas that are of particular interest and uncertainty within EROI analysis: (1) system boundaries, (2) energy quality corrections, (3) energy-economic conversions, and (4) alternative EROI statistics.

2. System Boundaries

Selecting the appropriate boundaries for an EROI analysis is a crucial step that is often overlooked. For example, much of the research on the EROI of corn ethanol has been reported as if each study used the same boundaries, but in fact most use different inputs and outputs, *i.e.*, have different boundaries, and are therefore incommensurable [13]. Life-Cycle Assessment (LCA) is a somewhat similar analytical technique that has addressed the issue of boundaries with fair success by creating an explicit methodological framework [14]. Within LCA, a boundary is chosen *a priori* and all inputs beyond that boundary are excluded from analysis. Although this framework creates results that can be compared explicitly, there are sometimes additional insights that can be gained by comparing analyses that utilize different boundaries [15]. For example, the paper by Henshaw *et al.* in this issue makes a strong argument for including the energy costs of all monetary expenditures required to produce energy. Hence we prefer a multidimensional framework that combines both a standardized and a flexible format.

Our objectives in this section are two-fold: (1) to provide a clear and concise conceptual framework for choosing the appropriate boundaries for the standard EROI analysis as well as for other energy ratios, (2) to provide an official nomenclature for the standard EROI and for other energy ratio calculations. Some of the ideas and methodologies from this section were borrowed from Mulder and Hagens [13].

There are a number of dimensions along which a system boundary may vary. One dimension runs “parallel” to the energy process chain from extraction (‘mine-mouth’) to intermediate processing (‘refinery gate’) to distribution (final demand) and determines the numerator in the EROI ratio, in answer to the question, “what do we count as energy outputs?” This dimension is depicted with the three system boundaries in Figure 1. Another dimension over which the system boundary may vary is to include a greater variety of direct and indirect energy and material inputs which determine the denominator of the EROI ratio, in answer to the question “what do we count as inputs?” This is illustrated in Figure 1. Level 1 includes only those inputs from the energy chain under investigation, level 2 incorporates energy inputs from the rest of the energy sector (this highlights the difference between the EROI, the internal and external energy ratios discussed in Section 5). Level 3 includes energy inputs embodied in materials, levels 4 and 5 incorporate energy embodied in supporting labor and other economic services.

There are two main techniques within energy analysis to assess the energy flows through a particular process or product: (1) process analysis, or (2) economic input-output. Process analysis, also

known as bottom-up analysis and akin to life-cycle analysis, accounts for the energy inputs and outputs in a process by aggregating them through the sequential stages of production. Economic input-output analysis, or top-down analysis, converts economic input-output tables into energy units by multiplying by sector-specific energy intensity values. A third method is emerging that is a hybrid of both of these methods. The choice of which method to use is normally made on the basis of where the system boundary is drawn (see Figure 1 and Figure 2), or by data restrictions.

Figure 1. Biophysical model of the energy-economy system based on Hall *et al.* [16] (p.38). The energy system is depicted as a series of processing stages: extraction, processing and distribution. The economy is split into four sectors: industrial, residential, transport and public, with associated outputs. The scale of the system boundary may vary along the process chain dimension.

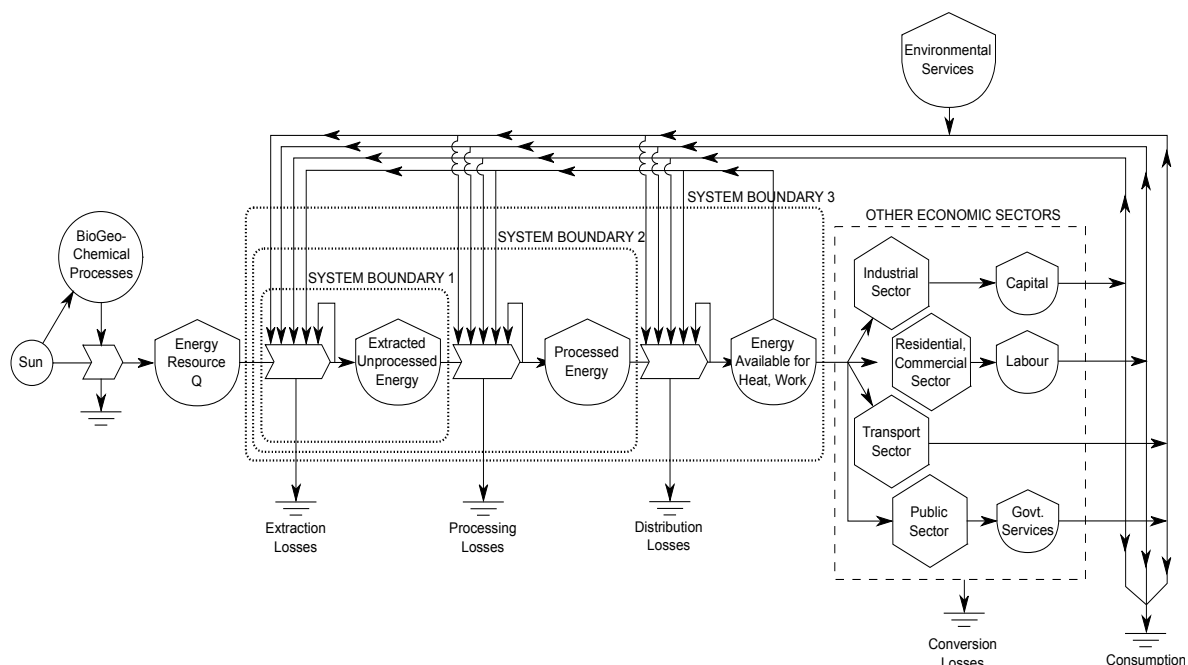
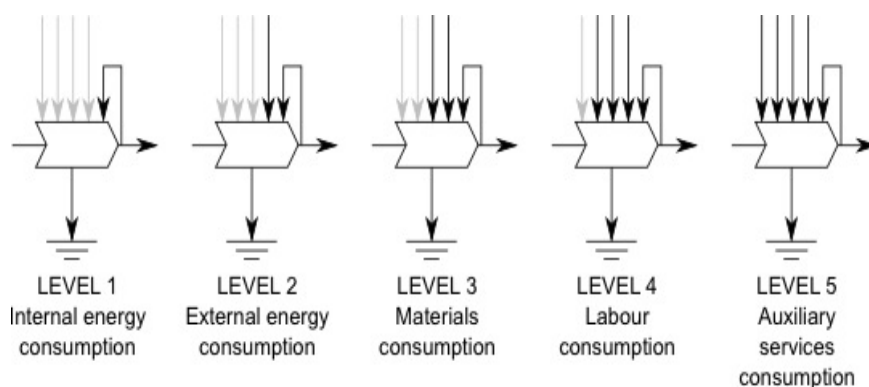

Figure 2. Production process with increasing levels of analysis by expansion of the system boundary to include more inputs.



For any production process, energy inputs may take a number of forms. Perhaps the most obvious is the energy used directly in the process itself, *i.e.*, diesel fuel consumed on a drilling rig. But one may want to consider as well the energy that has been used to extract and deliver the material inputs to a process, such as the energy used to build the drilling rig. These machines involved in a process have also required energy for their manufacture, as have the machines that built those machines, and so on. We can differentiate amongst energy and material inputs as direct and indirect inputs, with numerous subdivisions within these broad classifications. For example, direct energy inputs consist of fuels used to run tractors for corn harvesting or natural gas used on a drilling platform, while indirect energy inputs would be the fuel used to run a farmer's car when he goes to get a part or to fly the laborers out to the drilling rig. Meanwhile, direct material inputs would be the embodied energy of the tractor or drilling rig, while indirect material inputs would be the embodied energy of the farmer's car or the helicopter.

Some components, such as labor, can be considered both direct and indirect energy inputs. Direct labor costs occur as muscle power used on the rig itself while indirect labor costs occur by the energy used to support the paychecks of the workers within steel mills that produce the steel to build the rig. Another category of inputs, external costs, or externalities, are costs imposed on society by the process under study but which are not reflected in the market price of the good or service. Burning diesel fuel to drill for oil releases sulfur and other greenhouse gas emissions into the atmosphere, a cost that is borne by society at large and one that is not accounted for when using the heat equivalent of the fuel as the only cost, and thus represents a limitation of EROI analysis. Emergy analysis is an attempt to include all energy inputs, including those from nature, with differential quality values (*i.e.*, transformities) for each [17]. It is rarely used in energy analysis, but because of its comprehensive nature offers a useful upper limit to energy inputs.

Figure 3. Hierarchical levels in energy analysis from (N. J. Peet) [18]. If only level 1 and 2 inputs to a process are of interest then the analyst may use process analysis, if higher level analysis is required then input-output tables must be used. GER is “gross energy required”.

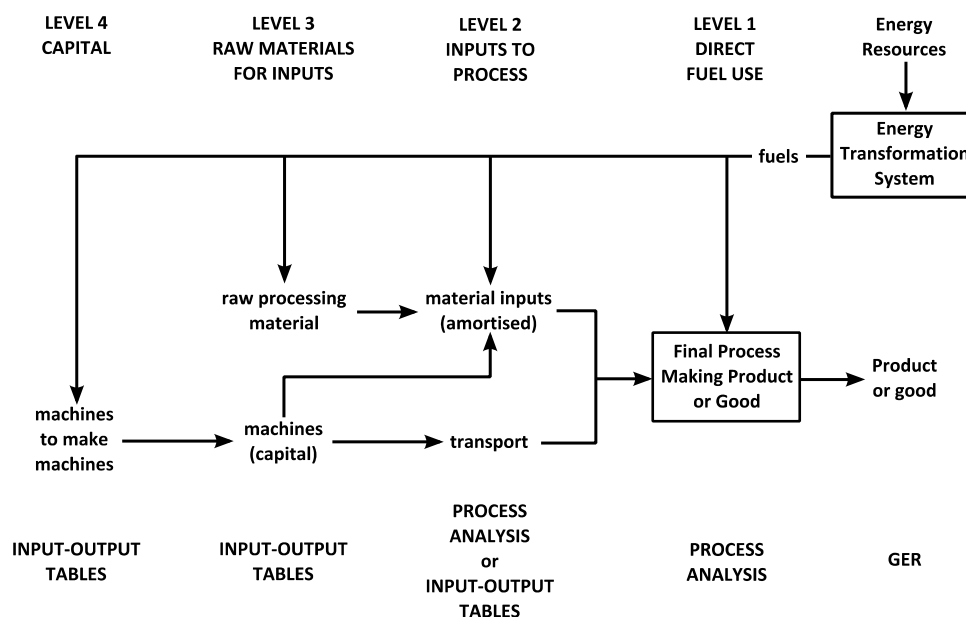

Expanding the boundaries of an energy analysis tends to increase quickly the amount of data collection and analysis needed to calculate and energy ratio. In most cases, if the analyst is interested only in either direct fuel use or the direct material and transport inputs (as represented by levels 1 and 2), then process analysis may be used. If a higher level analysis is required, including material inputs for capital goods and the “machines to make the machines”, then input-output (I-O) tables will most likely prove more useful (Figure 3). A problem with that approach is that there has been essentially no good and reviewed work on the subject in the US for decades, with the possible exception of the unreviewed but easy to use numbers from the Green design Institute at Carnegie Mellon University, available on line.

The system boundary may also vary along a temporal dimension. Figure 4 depicts an energy production project that begins at time t , with its construction, requiring a total energy input to construction of E_c . This energy is assumed to be used at a constant rate over the construction time, t_c , such that the energy flow to construction is:

$$\dot{E}_c = E_c / t_c$$

Once the project starts producing energy it is assumed to produce a constant gross flow of energy at rate \dot{E}_g over the whole lifetime t_L . An energy flow, \dot{E}_{op} , is required to operate and maintain the project. At the end of the project lifetime, some energy, E_d is required for decommission [19]. The total net energy output from the plant over the whole lifetime is:

$$E_{net} = E_g - E_{op} - E_c - E_d$$

and the EROI is defined as:

$$EROI = \frac{E_g}{E_c + E_{op} + E_d} \quad (1)$$

When considering a system composed of many such plants with construction, operation and decommission staggered through time, such as the US oil industry, it becomes more difficult to define the lifetime over which energy inputs and outputs are being produced and invested. In such cases, the EROI is often defined such that,

$$EROI = \frac{\dot{E}_g}{\dot{E}_c + \dot{E}_{op} + \dot{E}_d} \quad (2)$$

This formulation of the EROI makes the assumption that investments and returns from those investments occur in essentially the same time period. This assumption would be accurate only if the system is in “steady state”, *i.e.*, not growing or shrinking. It is important to note in this case that the EROI will be reduced in periods of heavy investment (such as happened during periods of high oil prices in the Seventies), which come to fruition only in subsequent years, during which time the EROI may be inflated.

Figure 4. Energy inputs and output from an energy production project (adapted from Herendeen) [19].

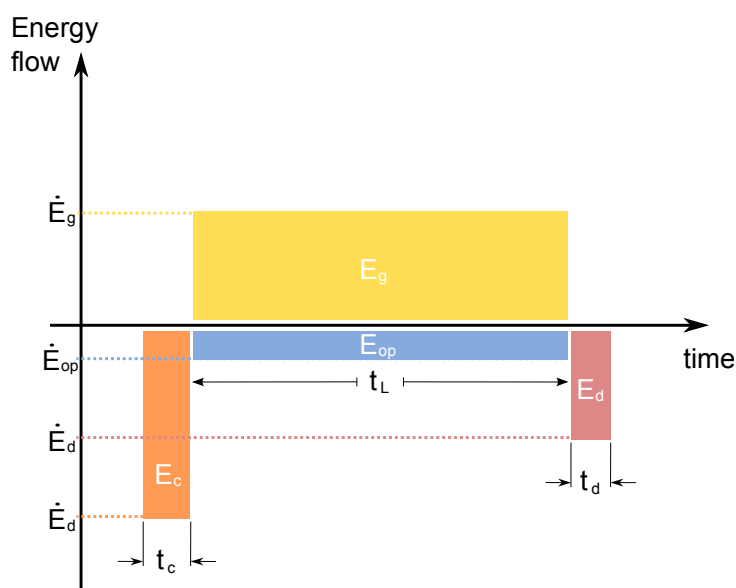

2.1. A Two-Dimensional Framework for Choosing Boundaries in EROI Analysis

Establishing clear goals and objectives are the first steps in selecting the boundaries of an EROI analysis. For example, stating that the goal of a particular study is to “calculate the EROI of the production of corn ethanol, inclusive of on-farm and refinery costs,” gives the reader some perspective from the outset about the scale of the study being performed. Other studies may have similar objectives that require different boundaries. If the objective of another study was to “calculate the EROI of the production of corn ethanol inclusive of all costs incurred from the farm to the end-user”, the reader would realize that the boundaries of analysis for this study will be wider than the boundaries in the first study, and as a result, the EROI numbers calculated in these two studies should not be compared directly.

Once the objectives have been outlined, choosing the appropriate boundaries for an EROI analysis depends largely on two factors: (1) what level of energy inputs are going to be considered in the analysis (*i.e.*, Figure 2), and (2) the methods chosen to aggregate energy units. Sometimes the data needed for analysis is defined in non-energy units (*i.e.*, water in cubic meters). There are two methods for handling non-energy inputs in an EROI calculation. The first method, used most often, is to ignore (or simply list) non-energy inputs in the EROI analysis. The second is to convert the non-energy input into energy units using heat equivalents, or in emergy analysis, a weighting factor (called a transformity). When using heat equivalents for inputs and outputs, there are two options as well: nonquality-corrected and quality-corrected heat units. This difference arises from the idea that not all joules are created equal, and the economic utility of a unit of electricity is different from the utility of a unit of coal [20]. When aggregating heat units of different types of energy, a quality correction is often used to account for these differences. The various methods of accounting for quality differences in energy are discussed in the next section.

We can represent the information presented thus far in a simple, two-dimensional framework (Table 1). The first row of Table 1 lists the system boundaries for energy outputs, *i.e.*, the numerator of the EROI calculation. The boundary for the inputs is listed along the left side of the table. Thus it is possible to have a narrow boundary for the energy output, such as crude oil from an oil well, while using a very wide boundary for the energy inputs, such as the labor used to construct the steel to build the oil rig. Alternatively, one could use a very wide boundary for the energy outputs, such as the gasoline consumed by the end user, and a narrow boundary for the energy inputs, *i.e.*, including only direct energy and material inputs at each stage in the production process.

Table 1. Two-dimensional framework for EROI analysis. The system boundaries, which determine the energy produced from a process (*i.e.*, the numerator of an EROI calculation) are across the top, while the boundaries that determine the energy inputs (*i.e.*, the denominator of an EROI calculation) are listed down the left. The shaded cells represent those with boundaries that favor economic input-output analysis while the other cells favor process-based analysis.

Boundary for Energy Inputs		Boundary for Energy Outputs		
		1. Extraction	2. Processing	3. End-Use
1	Direct energy and material inputs	EROI _{1,d}	EROI _{2,d}	EROI _{3,d}
2	Indirect energy and material inputs	EROI _{std}	EROI _{2,i}	EROI _{3,i}
3	Indirect labor consumption	EROI _{1,lab}	EROI _{2,lab}	EROI _{3,lab}
4	Auxiliary services consumption	EROI _{1,aux}	EROI _{2,aux}	EROI _{3,aux}
5	Environmental	EROI _{1,env}	EROI _{2,env}	EROI _{3,env}

The nomenclature suggested for EROI analyses follows logically from Figure 1. A researcher needs only to select the appropriate box for their specific research project and use the EROI tag associated with that box. For example, an EROI analysis that focuses on the extraction phase and includes simply the direct energy and material inputs would be deemed EROI_{1,d}. The “1” refers to the boundary for energy outputs in Table 1, while the “d” refers to the fact that only “direct” inputs are being considered. Since most EROI analyses account for both direct and indirect energy and material inputs, we have deemed this boundary to be the “standard EROI,” and assigned it the name EROI_{std}. Most often, the boundaries of an EROI analysis will be determined by the data available or the objectives, so it is advisable that the data be categorized into direct, indirect, *etc.* ... so that the appropriate row in Table 1 can be chosen. We suggest that future EROI analyses include the calculation of EROI_{std}. If all EROI research includes this calculation in addition to any other EROI calculations, then we will have a basis by which to compare all energy resources. As a first step in this process, essentially all of the EROI calculations in the articles in this special issue have included calculations of EROI_{std} in addition to whatever other EROI calculations were performed. If both labor and environmental costs in addition to indirect costs are considered then you can write EROI_{1,i+lab+env} and so on. The important thing is to make what you include very clear.

2.2. An Example of Multiple Boundary EROI Analysis

Hall *et al.* [15] published a paper that calculated 3 different EROI values for the transportation system of the U.S., each EROI corresponding to standard, point of use, and “depreciation” [15]. $EROI_{\text{std}}$ represents only the direct and indirect energy inputs and outputs from the oil extraction process up to the well-head. $EROI_{\text{1,pou}}$ translates the same considerations to “point of use,” and this statistic includes direct energy inputs and outputs following the extraction (i.e. $EROI_{\text{std}}$), refining and transportation of fuel to the point of use, *i.e.*, gas station. Thus $EROI_{\text{pou}}$ represents an example of an EROI calculation that is specifically useful for this analysis, and would represent an additional row in Table 1 if it were added. $EROI_{\text{ext}}$ is the widest boundary EROI calculated in Hall *et al.*, and it represents all direct and indirect energy costs as well as the energy required to use that energy, including depreciation energy costs, such as the pro-rated maintenance of roads, bridges and automobiles that is necessary to maintain transportation networks to use that oil. $EROI_{\text{ext}}$ would constitute another row in Table 1 if it were added. Since Hall *et al.* [15] chose to use the non-quality corrected energy units, all the EROI calculations are within the first column of Table 1.

3. Energy Quality

There are many different factors that determine the quality of a heat unit of fuel. We adopt the definition of energy quality proposed by Cleveland *et al.* [9]: the relative economic usefulness per heat equivalent unit of different fuels and electricity. Energy quality is determined by a complex set of attributes unique to each fuel such as physical scarcity, capacity to do useful work, energy density, cleanliness, amenability to storage, safety, flexibility of use, cost of conversion, and so on. One major criticism mounted against EROI research has been that it ignores many of these factors that determine the quality of an energy source. Converting all energy inputs to common energy units using only heat equivalents assumes implicitly that a joule of oil is of the same quality as a joule of coal or a joule of electricity. Since this is clearly not the case, we should account for differences of energy quality within EROI analysis when this is possible. Sometimes this can be done by incorporating the energy cost of upgrading the fuel to a given quality in the denominator while specifying the quality of the numerator.

There is uncertainty associated with all quality adjustments, as there is uncertainty with nearly any quantitative estimate outside the laboratory, but we believe the quality-adjusted energy units used in an EROI analysis are no better or worse on average than the numbers used in monetary cost-benefit analysis or other weighting procedures in economics.

Standard, non-quality corrected EROI calculations use thermal equivalents for all fuel sources to aggregate energy inputs:

$$E_t = E_{1t} + E_{2t} + \dots + E_{nt} \quad (3)$$

where E is an amount of energy of n types of energy sources in time period t . There are numerous methods to adjust for quality, and the following discussion of quality conversions is based on the options given in Cleveland (1992) and Cleveland (2000) [9,21].

3.1. Economic Methods to Adjust for Quality

Priced-based adjustment emerged from the literature as the method of choice when adjusting for energy quality. According to neoclassical economic theory, the price

$$\eta_{nt} = \frac{P_{nt}}{P_{1t}}$$

per heat equivalent of fuel represents a myriad of factors that determine a fuel's utility, or quality, per heat unit. For these reasons the price per joule of electricity is greater than the price per joule of coal, *i.e.*, electricity is more useful and therefore demands a premium price. The following equation calculates weights for each fuel type, n , for each time period t :

$$EROI = \dot{E}_g / (\dot{E}_c + \dot{E}_d + \dot{E}_{op}) \quad (4)$$

where: η_{nt} is the weight assigned for energy type n in time period t , P_{1t} is the price of the reference fuel chosen at time t , and P_{nt} is the price of fuel n at time t . For example, if oil is chosen as the reference fuel, then the price per joule of electricity, coal, and all other energy types are divided by the price per joule of oil in time period t . Each weight is then multiplied by the amount of consumption of that fuel type during time period t to obtain the quality-adjusted energy input to the process.

$$E'_t = \eta_{1t}E_{1t} + \eta_{2t}E_{2t} + \dots + \eta_{nt}E_{nt} \quad (5)$$

where E' is the quality-adjusted energy aggregation and η is the weight of energy source η in time period t .

There are important assumptions with this method of quality adjustment. For example, using this type of price-based adjustment assumes that all fuels are perfectly substitutable [9]. As the price of one fuel increases relative to another, it can be replaced easily and fully. Although fuels are partial-substitutes, they are not perfectly substitutable, as is evident by the fact that energy users pay a premium for electricity and/or oil, more versatile energy sources, relative to coal, even though they can get the joule-equivalent energy in the form of coal for a cheaper price [22].

This method of comparing relative prices is sensitive also to rapid changes in the price of the reference fuel used. If one were using oil as a reference fuel, the doubling of the price of oil in 2008 would indicate that the quality of all other fuels decreased by half.

Yet if this same index were calculated using coal as the reference during the same period no such trend would appear across the whole index, except for the quality-weight for oil prices. Berndt (1978, 1990) suggests an adjusted form of the relative price approach that utilizes fuel shares as well as prices to weight the quality of each fuel type [22,23]. Berndt refers to this methodology as the "Divisia Index", which is calculated according to the equation (repeated from [6]):

$$\ln E'_t - \ln E'_{t-1} = \sum_{n=1}^k \left(\left(\frac{P_n E_{nt}}{2 \sum_{n=1}^k P_n E_{nt}} + \frac{P_{n-1} E_{n-1}}{2 \sum_{n=1}^k P_{n-1} E_{n-1}} \right) (\ln E_{nt} - \ln E_{n-1}) \right) \quad (6)$$

where p is the price of n different types of fuels and E is the final consumption of energy (joules) for each fuel type. This method allows for partial substitution amongst different fuel types and eliminates the over-dependence on a reference fuel type.

3.2. Shortcomings of Price-Based Adjustment

There are some shortcomings of a price-based weighting system. Many environmental and social costs are not incorporated into the market price for a fuel. These *externalities* cast doubt on the usefulness of using a price-based weighting system when comparing the sustainability of various extraction/production systems. But the problem of externalities can be ameliorated to some extent by including externalities in prices, such as through cap and trade programs for greenhouse gas emissions. Within this scenario, prices will increase as externalities are included and as this increase switches fuel shares to the low cost producer, the Divisia Index will shift as well.

Fundamentally, the fact that fuels have different prices per joule indicates that factors other than heat content are valued by energy consumers. Given the aforementioned shortcomings, prices produce quality weights for fuels that can be used to adjust energy data for differences in quality [20]. We suggest that EROI studies use either equation five or six to adjust energy data by the quality of fuel types, noting the assumptions and limitations of each method.

3.3. Quality Adjustments Using Physical Units

Exergy is a means by which one can account for quality differences between energy carriers using purely physical measures. It is defined as a measure of the ability of a system to perform work in the process of equilibrating with a reference state (normally chosen to be the atmosphere at standard temperature and pressure) [24]. As work is performed exergy is consumed until a point is reached at which the system under study has equilibrated with a reference state. Because a kilogram of oil can perform more work than a kilogram of coal because of its greater energy density, the exergy of oil is higher than that for coal (Table 2). In this way, exergy provides a method to quality-correct energy carriers based on physical units. It should be mentioned that, although both exergy and prices can be used to adjust for quality differences in energy carriers, they are different metrics. That is, prices are based on differences in density, transportability, *etc.*, whereas exergy is based only on differences in the ability to do work [6].

Table 2. Specific exergy of different fuels, from Hermann [24].

Fuel	Exergy [MJ/kg]	Error (+/-)
Coal	25.00	5.00
Bituminous coal (Blacksville)	29.81	
Bituminous coal (Absaloka)	19.87	
Petroleum	42.00	2.00
Heavy oil (bitumen)	40.00	
Oil shale (Estonian)	12.00	
Tar sands (US)	6.00	
Natural gas (representative, 80% humidity)	50.50	
Methane clathrate (Mid-America trench)	4.80	
Uranium 235	75000000.00	
Uranium 238	77000000.00	
Thorium 232	78000000.00	

Table 2. Cont.

Fuel	Exergy [MJ/kg]	Error (+/-)
Lignin	25.00	
Cellulose	17.00	1.00
Eucalyptus (dry)	19.90	
Poplar (dry)	19.20	
Corn stover (dry)	18.20	
Bagasse (dry)	17.80	
Water hyacinth (dry)	15.20	
Brown kelp (dry)	10.90	
OTEC (20K difference)	<0.01	
Geothermal (150K difference)	0.13	

Whereas total energy is conserved in every process, exergy is not. Exergy consumption is proportional to entropy creation [25]. The exergy, E , of a system A in an infinite (*i.e.*, unchangeable) environment A_0 , is defined as:

$$E = U + P_0V - T_0S - \sum_i \mu_{i0}n_i$$

Where U , V , S and n_i are respectively the internal energy, volume, entropy and number of moles of material type i of system A. P_0 , T_0 and μ_{i0} are the pressure, temperature and potentials (e.g., chemical, nuclear, gravitational, *etc.*)[26] of material type i for the environment A_0 . U is calculated using the Gibb's relation:

$$U = ST - VP + \sum_i n_i\mu_i$$

Substituting, we find a new formulation for the exergy of system A_0 :

$$E = S(T - T_0) - V(P - P_0) + \sum_i n_i(\mu_i - \mu_{i0})$$

From this formulation we can see that once system A has equilibrated with the environment A_0 (*i.e.*, $T - T_0 = P - P_0 = \mu_i - \mu_{i0} = 0$) then the exergy of system A is zero. In other words, all of the exergy has been consumed, and no further work can be accomplished.

3.4. Shortcomings of Exergy-Based Adjustments

Exergy is an attractive approach to adjusting energy data for differences in quality since it avoids using economic data, such as prices, and the problems associated with them (e.g., inflation). However, exergy cannot capture many properties of a fuel or energy carrier that contribute to its economic attractiveness, such as transportability, global warming potential, toxicity, or cleanliness [9]. Exergy analyses also ignore important critical inputs such as capital and labor [27]. Economic methods may be able to capture such characteristics.

4. Deriving Energy Intensities from Economic Data

Often, the only data available, or available for free, for capital equipment and other energy or material inputs is economic data. Because of this, there is often a need to convert dollars to energy units. The most straightforward method is to use an energy intensity value, *i.e.*, a value reported in units of energy per dollar (ex. joules per dollar). Which energy intensity value should be used is a more difficult question to answer.

Dividing energy consumption by dollar output for a given economy and time period yields an average energy intensity value that can then be used to convert other monetary information to energy units. This average energy intensity is a measure of the output, measured in dollars (or other currency), created from a given amount of energy input to the economy or process. Although useful for quick calculations, the basic national-level energy intensity value is a coarse measurement, as it averages values across sectors of the economy that are quite different. The average energy intensity for the U.S. economy in 2005 was 8.3 MJ/\$ (Table 2). We provide other data (mostly based on heat equivalents per ton) from 2005 in Table 3

Oil and gas production are energy-intensive sectors of the economy as is general industrial production (e.g., of drill bits, pipes and so on). Bullard and Herendeen (1975) and Costanza (1980) recognized the shortcomings of using mean national energy intensity values and instead derived very explicit industry-specific values using Leontief type input-output (I-O) tables and industry-specific energy intensities to calculate sector-specific energy intensity values for the U.S. economy [28,29]. An inflation- corrected value for heavy industries derived from earlier work by Bullard, Hannon and Herendeen (about 16,000 Kcal per dollar in 1972), is 14.3 MJ/dollar in 2005 when corrected for units and inflation with the Consumer Price Index (CPI).

These data are very comprehensive but very old. Herendeen (pers. comm.) suggested in 2005 that while far from perfect one can use the more recent I-O energy intensities derived from the Carnegie Mellon web site for a general upstream average for inputs to the energy sector [30]. There are sometimes disquieting differences from one category to another, but they are the best we have now. One derives from their “model” a value of 14.5 MJ energy used per dollar spent for “oil and gas extraction” in 2002. This value is about half way between the energy intensities for the entire economy (8.3 MJ per 2005 dollar) and for money spent by the US and the UK by the entire oil and gas exploration and development industry, including the money spent directly on energy itself. Gagnon *et al.* (2009) estimated that the energy intensity for oil and gas exploration was 20 MJ/dollar in 2008 [12]. Thus we use an energy intensity for industrial activity (*i.e.*, for things purchased by energy companies) of 14 MJ/dollar in 2005. That value for another nearby year can be derived using the consumer price index. When we used oil-industry specific correctors some were higher and some lower than the CPI, so we did not feel that anything was gained from using other inflation-adjusters than the CPI.

Table 3. Various conversions used commonly in EROI analysis.

Unit	Conversion Factor	Reference
Primary Energy (Heat Content)		
Oil	6.12 (GJ/bbl)	[31]
Natural Gas	41 (KJ/m ³)	[31]
Coal	22 (GJ/tonne) ^a	[31]
Energy Intensities (for year 2005)		
	MJ/\$	
average U.S. economy	8.3	[15]
average heavy industry	14	[15]
average oil & gas exploration and dev.	20	[12]
Material Costs		
	GJ/tonne	
Aluminum	241.2	[32]
	100.2	[33]
	272.2	[34]
	11.7 ^b –140	[35]
Steel	32.4	[32]
	9.43 ^c –25.2 ^d	[35]
Copper	200.2	[33]
	93.7	[36]
	104.4	[37]
	51.7–179.7	[38]
	0.08–255.7	[39]
Cement	5.5	[34]
Iron Ore	0.34–2.9	[39]
Stone	0.021–0.057	[39]
Limestone	0.034	[39]
Lead	1.4–31.1	[39]
Zinc	76	[39]
Phosphate	0.083–0.349	[39]
Glass		
Molten Flint Glass	14.2	[35]
Molten Emerald Glass	11.7	[35]
Molten Amber Glass	13.2	[35]
Plastics		
Polyvinyl Chloride (PVC)	59.8	[35]
General Purpose Polystyrene (GPPS)	84.8	[35]
High Density Polyethylene (HDPE)	89.5	[35]
High Impact Polystyrene (HIPS)	87.4	[35]
Low Density Polyethylene (LDPE)	93.9	[35]
Polyethylene Terephthalate (PET)	88.9	[35]
Polypropylene (PP)	88.5	[35]
Linear Low Density Polyethylene (LLDPE)	83.4	[35]
Wood^e		
Dry Lumber	2.33	[35]
Green Lumber	0.95	[35]

^a Average U.S. coal production; ^b secondary aluminum ingot; ^c Electronic Arc Furnace Billet; ^d Hot Rolled Coil (Integrated Mill); ^e Average of hardwood and softwood.

The specific energy intensity values used in an EROI analysis should match the general level of precision of the EROI analysis being performed. For example, if one is calculating the EROI of exploration and development within the oil and gas sector, and the only exploration data obtainable is the dollar cost of building a drilling platform, then an energy intensity value calculated for heavy industry, or optimally for oil and gas exploration in that country, should be used. The best option is to get direct energy and material use estimates and hence avoid the use of energy-intensity values altogether, but this is rarely possible. In most cases, we believe that omitting data because it uses dollars instead of energy units creates more error than including that data via an energy intensity conversion. Many of the papers in this special issue explore uncertainties associated with these values through sensitivity analysis.

5. Alternative EROI Statistics

5.1. Fossil Energy Ratio

The widespread application of net energy analysis to different fields of science has led to the creation of numerous variants of the conventional EROI statistic (now referred to as $EROI_{std}$) [40]. Two variants in particular seem to garner the most attention within the literature. The first alternative EROI statistic is called “Fossil Energy Ratio” (FER), which compares the total energy gains from fossil fuel investment only. FER is used often in the discourse on biofuels; much of the energy inputs to biofuel production are technically renewable, such as burning biomass during the production of corn ethanol, so FERs tend to be much higher than EROIs for biofuels [41].

5.2. External Energy Ratio

The second alternative EROI statistic is called “External Energy Ratio” (EER). EER is a useful measure for energy production techniques that consume a significant amount of energy derived *in situ*. For example, one method of tar sand production burns a portion of the bitumen *in situ* as a means to heat and crack the surrounding bitumen so that it will flow more easily. Since the heat energy derived from the bitumen originates within the extraction process, it is excluded from an EER calculation, although it would be included within a conventional EROI calculation. EER is calculated as:

$$EER = O_d/I_d + I_{emb} + I_l$$

Both FER and EER are more restricted forms of the standard EROI calculation. By definition both FER and EER must be greater than or equal to the standard EROI for the same system, since FER and EER use a sub-sample of the total energy inputs to a process, yet include the same energy output.

5.3. Net Energy Yield Ratio

The net energy yield ratio (NEYR) has as the numerator the net energy from the energy production process and all of the inputs necessary to produce that net flow as the denominator:

$$NEYR = \frac{O_d - I_d - I_{rec} - I_{emb} - I_{lab}}{I_d + I_{rec} + I_{emb} + I_{lab}}$$

5.4. Absolute Energy Ratio

The absolute energy ratio (AER) includes in the denominator the energy content of the energy resource from the natural environment, I_0 , which is being processed [19]. As such the AER must be less than unity. It may be considered a “life-cycle” efficiency:

$$AER = \frac{O_d}{I_0 + I_d + I_{rec} + I_{emb} + I_{lab}}$$

6. Step by Step Instructions for EROI Analysis

The objective of this section is to combine the different aspects of EROI analysis presented in sections one through five into a short, unambiguous procedure for conducting an EROI analysis.

Step 1. State objectives

The first step in performing an EROI analysis is to state the objectives of the analysis clearly. This will allow the reader to get a sense of the scale of analysis being performed and whether or not there are other analyses with similar objectives.

Step 2. Create a flow diagram and identify system boundaries

Figure 1 represents a generic flow diagram for any system, and can be used as a reference. The symbolism developed by Odum (1983) and Hall and Day (1977) for systems flow diagrams is recommended when drawing the flow diagram for an EROI analysis [42,43]. All direct indirect, and embodied energy inputs and outputs should be included in this flow diagram.

Step 3. Identify all appropriate inputs and outputs within system boundaries

Once the flow diagram is complete, the various flows of energy, defined by arrows connecting two symbols, should be identified and labeled on the flow diagram as either direct, indirect, or embodied energy inputs or outputs. We recommend using the concepts and nomenclature developed in Figure 1 as a base.

Step 4. Identify data needed for the calculation of EROI_{std} as well as any other EROI calculations

Once steps one through three are completed, the analyst should have sufficient knowledge to identify which specific EROI calculation is being performed as, or in addition to, EROI_{std}. At this point the analyst should identify the specific EROI calculations that they are performing by using the labels provided in Table 1 and define the EROI equation by placing the appropriate energy flows from the flow diagram developed in step 1 into the numerator and denominator of the EROI calculation.

Step 5. Choose method of energy quality adjustment

All of the energy inputs and outputs should be undertaken with both heat equivalents and quality-adjusted energy if possible. We recommend using a price-based aggregation or a Divisia approach for quality adjustments, as outlined in Section 3, unless there is a good reason for doing otherwise. At a minimum, electricity should be multiplied by a factor of 2.6 to represent mean thermal requirements. The analyst should spend time identifying the benefits and shortcomings associated with whichever method is chosen, including any underlying assumptions. For example, if an EROI analysis

Sustainability **2011**, *3*

uses mainly one energy type for inputs and outputs, then a quality adjustment adds little value. For most EROI analyses, a basic price-based adjustment is adequate.

Step 6. Identify and convert financial flows

Often times only financial data is available for energy flows, such as the cost of transporting oil. This data needs to be converted to energy units using an energy intensity value. Section 4 can be referenced for a full discussion of how to derive energy intensity values and which intensities are appropriate for various analyses. Once these financial flows are identified, convert them to energy units using whichever energy intensity value was chosen.

Step 7. Calculate EROI

This is the final step in the process where all of the energy units are aggregated and the EROI value is calculated. Each EROI analysis should have at a minimum the $EROI_{std}$ as well as any other EROI calculations of interest. The investigator can then compare his or her $EROI_{std}$ with others, and indicate whether and how an alternate EROI adds useful information.

7. Further Issues

A number of issues remain that have not been discussed in the preceding analysis. These are concerned with: (1) accounting for non-energy inputs or impacts; (2) access to data; (3) allocation of costs between co-products.

7.1. Accounting for Non-Energy Inputs and Impacts

It should be noted that although EROI analysis is useful because it provides a single statistic by which multiple energy options can be compared, it is limited in that all inputs and outputs must be converted to energy units. Often there are inputs or outputs from a process that are valuable for reasons other than their energetic value. Water for irrigation is a good example. Although we can calculate the energy cost of irrigation, this does not account for water's role in photosynthesis or the relative scarcity, pollution or depletion of water in an aquifer. In addition, "outputs" from energy production such as pollution (externalities in economic terms) are difficult to capture in energy terms. These types of issues are of current interest in EROI research, but until a consensus emerges as to how to handle non-energy inputs and outputs, energy equivalents should be used. Each researcher should note any of these types of important methodological assumptions within their study.

7.2. Access to Data

When studying real world systems, there is always a trade-off between the costs involved and the benefit accrued in obtaining more data. Much of the data needed for energy analysis is not kept by the organizations running the processes involved. In many cases this speaks to the need to convert economic to energy data (as discussed in Section 4). There now exist many LCA databases (such as Gabi or SimaPro) storing information on energy inputs to various materials. As these kinds of analyses become more widespread, this information will become available.

7.3. Allocation Between Co-Products

Many production processes produce more than one type of good. A good example is an oil refinery that produces many chemicals, e.g., lubricants, as well as various grades of fuel. How should the costs of production be allocated between these different goods? Three options present themselves immediately: allocation by mass, allocation by energy content (either heating value, exergetic or division weighted), or allocation by price. The division of costs will be different in each case and it is unclear that one method is clearly “better” than any other. This issue is discussed extensively within the LCA literature (e.g., Reap *et al.*, 2008 and Curran, 2007) [44,45].

In conclusion we believe that if these protocols are followed (including our provisions for flexibility) that EROI can rightfully take its place as a very powerful tool for evaluating some very important aspects of the utility of different fuels, and for helping to understand the implications of EROI changes for our economy as partly outlined in the introduction to this special issue. Most importantly good EROI analysis can save us from investing large amounts of our remaining fossil fuels into alternative fuels that contribute little or nothing to our nation’s financial or energy well being, as appears to have been the case with corn-based ethanol and is likely to be the case with many energy alternatives that are being promoted by various interests.

Acknowledgements

We thank Ajay Gupta for providing data on the energy cost of materials. Thanks as well to Tim Volk and Adam Brandt for many helpful comments, and two unknown reviewers. Most contributors to this special issue provided some valuable insights.

References and Notes

1. Lynch, M.C. Forecasting oil supply: Theory and practice. *Q. Rev. Econ. Finance* **2002**, *42*, 373-389.
2. Radetzki, M. Peak Oil and other threatening peaks-Chimeras without substance. *Energy Policy* **2010**, *38*, 6566-6569.
3. Campbell, C. Why dawn may be breaking for the second half of the age of oil. *First Break* **2009**, *27*, 53-62.
4. Campbell, C.J.; Laherrere, J.H. The End of Cheap Oil. *Sci. Am.* **1998**, *278*, 78-83.
5. Farrell, A.E.; Plevin, R.J.; Turner, B.T.; Jones, A.D.; O’Hare, M.; Kammen, D.M. Ethanol can contribute to energy and environmental goals. *Science* **2006**, *311*, 506-508.
6. Cleveland, C. Net energy from the extraction of oil and gas in the United States. *Energy* **2005**, *30*, 769-782.
7. Murphy, D.J.; Hall, C.A.S.; Powers, B. New perspectives on the energy return on (Energy) investment (EROI) of corn ethanol. *Environ. Dev. Sustainability* **2010**, *13*, 179-202.
8. Hammerschlag, R. Ethanol’s energy return on investment: A survey of the literature 1990–present. *Environ. Sci. Technol.* **2006**, *40*, 1744-1750.
9. Cleveland, C.J.; Kaufmann, R.K.; Stern, D.I. Aggregation and the role of energy in the economy. *Ecol. Econ.* **2000**, *32*, 301-317.

10. Murphy, D.J.; Hall, C.A.S. Year in review-EROI or energy return on (Energy) invested. *Ann. N. Y. Acad. Sci.* **2010**, *1185*, 102-118.
11. Guilford, M.C.; Hall, C.A.S.; O'Connor, P.; Cleveland, C.J. A new long term assessment of energy return on investment (EROI) for U.S. oil and gas discovery and production. *Sustainability* **2011**, *3*, 1866-1887.
12. Gagnon, N.; Hall, C.A.S.; Brinker, L. A preliminary investigation of the energy return on energy invested for global oil and gas extraction. *Energies* **2009**, *2*, 490-503.
13. Mulder, K.; Hagens, N.J. Energy return on investment: Towards a consistent framework. *Ambio* **2008**, *37*, 74-79.
14. *Environmental Management-Life Cycle Assessment-Principles and Framework*, ISO 14040:1997; ISO Copyright Office: Geneva, Switzerland, 1997. Available online: http://www.iso.org/iso/catalogue_detail.htm?csnumber=23151 (accessed on 8 December 2010).
15. Hall, C.A.; Balogh, S.; Murphy, D.J. What is the minimum EROI that a sustainable society must have? *Energies* **2009**, *2*, 1-25.
16. Hall, C.A.S.; Kaufmann, R.; Cleveland, C.J. *Energy and Resource Quality: The Ecology of the Economic Process*; John Wiley and Sons: Hoboken, NJ, USA, 1986.
17. Odum, H.T. Self-organization, transformity, and information. *Science* **1988**, *242*, 1132-1139.
18. Peet, J.; Baines, J. *Energy Analysis: A Review of Theory and Applications*; NZERDC Report No. 126: Auckland, Australia, 1986.
19. Herendeen, R.A. Net energy analysis: Concepts and methods. In *Encyclopedia of Energy*. Elsevier: New York, NY, USA, 2004; Volume 4, pp. 283-289.
20. Kaufmann, R.K. The relation between marginal product and price in U.S. energy markets. *Energy Econ.* **1994**, *16*, 145-158.
21. Cleveland, C.J. Energy quality and energy surplus in the extraction of fossil fuels in the U.S. *Ecol. Econ.* **1992**, *6*, 139-162.
22. Berndt, E.R. Aggregate energy, efficiency and productivity measurement. *Annu. Rev. Energy* **1978**, *3*, 225-273.
23. Berndt, E.R. Energy use, technical progress and productivity growth: A survey of economic issues. *J. Prod. Anal.* **1990**, *2*, 67-83.
24. Hermann, W.A. Quantifying global exergy resources. *Energy* **2006**, *31*, 1685-1702.
25. Rosen, M.A. Exergy analysis of energy systems. In *Encyclopedia of Energy*; Elsevier: New York, NY, USA, 2004; Volume 2, pp. 607-621.
26. According to Wall the potential, μ , is a means by which to include properties of a material which affect the internal energy, U , but which are not included in the classical thermodynamic state variables, for example, gravitational potential energy due to altitude. Wall, G. Exergy. In *Encyclopedia of Energy*, Cutler, J.C., Ed.; Elsevier: New York, NY, USA, 2008; Available online: <http://www.eoearth.org/article/Exergy> (accessed on 17 October 2011).
27. Hau, J.L.; Bakshi, B.R. expanding exergy analysis to account for ecosystem products and services. *Environ. Sci. Technol.* **2004**, *38*, 3768-3777.
28. Bullard, C.; Herendeen, R. The energy costs of goods and services. *Energy Policy* **1975**, *3*, 279-284.
29. Costanza, R. Embodied energy and economic valuation. *Science* **1980**, *210*, 1219-1224.

30. Economic Input-Output Life Cycle Assessment. Carnegie-Mellon: Pittsburg, Pennsylvania, 2009. Available online: <http://www.eiolca.net/cgi-bin/dft/use.pl> (accessed on 8 December 2010).
31. EIA. *Annual Energy Review 2009*; DOE/EIA-0384. U.S. Department of Energy: Washington, DC, USA, 2010.
32. Demkin, J.A. *Environmental Reserouce Guide*; John Wiley and Sons: Hoboken, NJ, USA, 1996.
33. Ruth, M. Thermodynamic constraints on optimal depletion of copper and aluminum in the United States: A dynamic model of substitution and technical change. *Ecol. Econ.* **1995**, *15*, 197-213.
34. *Energy Use, Loss and Opporutnities Analysis: U.S. Manufacturing and Mining*; U.S. Department of Energy: Washington, DC, USA, 2004.
35. Canadian Raw Materials Database. University of Waterloo: Waterloo, ON, Canada, 2010; Available online: <http://crmd.uwaterloo.ca/index.html> (accessed on 8 December 2010).
36. Castle, J.F. *Energy Consumption and Costs of Smelting*; IMM Institute of Mining and Metallurgy: London, UK, 1989.
37. *An Assesment of Energy Requirements in Proven and New Copper Processes*; U.S. Department of Energy: Washington, DC, USA, 1980.
38. Herendeen, R. University of Illinois: Edelstein, IL, USA, Personal Communication, 2010.
39. BCS. *Mining Industry of the Future: Energy and Evironmental Profile of the U.S. Mining Industry*; U.S. Department of Energy: Washington, DC, USA, 2002.
40. Spitzley, D.V.; Keoleian, G.A. *Life Cycle Environmental and Economic Assessment of Willow Biomass Electricity: A Comparison with Other Renewable and Non-Renewable Sources*; University of Michigan-Center for Sustainable Systems: Dearborn, MI, USA, 2005.
41. Shapouri, H.; Duffield, J.A.; McAloon, A.; Wang, M. The 2001 Net Energy Balance of Corn-Ethanol. In *Proceedings of the Corn Utilization and Technology Conference*, Indianapolis, IN, USA, 7–9 June 2004.
42. Hall, C.A.S.; Day, J.J.W. *Ecosystem Modeling in Theory and Practice*; University Press of Colorado: Boulder, CO, USA, 1977.
43. Odum, H.T. *Systems Ecology: An Introduction*; John Wiley and Sons: Hoboken, NJ, USA, 1983.
44. Reap, J.; Roman, F.; Duncan, S.; Bras, B. A survey of unresolved problems in life cycle assessment. *Int. J. Life Cycle Ass.* **2008**, *13*, 374-388.
45. Curran, M. Studying the effect on system preference by varying coproduct allocation in creating life-cycle inventory. *Environ. Sci. Technol.* **2007**, *41*, 7145-7151.

Review

A Review of the Past and Current State of EROI Data

Ajay K. Gupta * and Charles A.S. Hall

Graduate Program in Environmental Science, College of Environmental Science and Forestry,
State University of New York, Syracuse, NY 13210, USA; E-Mails: chall@esf.edu

* Author to whom correspondence should be addressed; E-Mail: ajgupta@syr.edu;
Tel.: +1-315-470-6812; Fax: 315-470-6934.

Received: 11 June 2011; in revised form: 1 August 2011 / Accepted: 5 August 2011/

Published: 10 October 2011

Abstract: This is a review of the literature available on data for the EROI (prior to this special issue) of the following 12 sources of fuel/energy: oil and natural gas, coal, tar sands, shale oil, nuclear, wind, solar, hydropower, geothermal, wave/tidal and corn ethanol. Unfortunately, we found that few studies have been undertaken since the 1980s, and such as have been done are often marked more by advocacy than objectivity. The most recent summary of work and data on the EROI of fuels was conducted in the summer of 2007 at SUNY ESF and appeared on The Oil Drum website and in a readable summary by Richard Heinberg. This paper summarizes the findings of that study, and also those preceding and subsequent to it where available. It also summarizes issues raised by some concerning the findings of these studies and with the calculations within. While there are many who believe that such EROI studies are critical to understanding our financial and social future there seems to be very little interest by governments and industries in supporting this research or in using or promulgating such research as has been done. We view this as critical as our main fuels are progressively depleted and as we are faced with making extremely important decisions on a very meager analytical and data base, and with few scientists trained to cut through the reams of insufficiently analyzed energy advocacy saturating our media and the blogosphere.

Keywords: energy return on investment; EROI data; EROI of fuels

1. Introduction

In the 1970's ecologist Charles Hall coined the term "Energy Return on Investment" (EROI), with originally a focus on migrating fish (e.g., Hall [1]). In the 1980s, Hall, working with Cutler Cleveland, Robert Kaufmann and others, extended the concept to seeking oil and other fuels. The concept had been around in the anthropological (e.g., Lee [2]), economic (e.g., Georgescu Roegan [3]), and ecological (e.g., Odum [4]) literature for some time, although it was expressed as "net energy." The difference is that EROI is the unit-less *ratio* of energy returned from an energy-gathering activity to the energy it takes to provide that energy, and net energy is the *difference* left over after the costs have been subtracted from the gains. Net energy can be useful but also misleading: it may be very large for a very large but poor quality resource (*i.e.*, oil shales) that allow a large net from huge resources subject to slightly less huge costs. Alternately when used with EROI it can help assess a resource from both perspectives.

EROI has more utility, in our opinion, because it allows the ranking of fuels and an estimate of the changing in their ease of extraction over time, which can also be interpreted as the difference between the effects of technology (which would be expected to increase EROI) and depletion (which would be expected to decrease it). It also should be linked to the economic cost of fuels (See King and Hall, this volume). One important idea is that as this ratio approaches 1:1 the fuel is no longer useful to society (except for the presumably rare case where a low quality fuel is used to produce a higher quality fuel). The original papers on EROI (e.g., Hall and Cleveland [5], Cleveland *et al.* [6], Hall *et al.* [7]), were mostly received with interest, but that interest waned in the late 1980s and 1990s as fuel prices declined. More recently as energy prices have again been increasing the interest in EROI has again increased (e.g., Heinberg [8], many web sites). Additionally many papers on energy and emerging economic fields discuss this ratio and what it means to current and future economies (e.g., Hall and Klitgaard [9], Hall [10], Mearns [11], Day *et al.* [12], Hall *et al.* [13], Hall and Day [14], Murphy and Hall [15]). However, given the number of decades the concept of EROI has been around, only a small, although growing, body of work is available on the subject [15].

In fact, despite the growing interest in EROI, little new data are available today except for what is in this much-needed special issue. Most such efforts have been to refine the EROI for certain fuels, mostly petroleum based fuels, and to examine the utility of corn-based ethanol—which are discussed below—but there is very little information available in terms of a large body of work providing data on a range of inputs important to our economies. The first attempted synthesis was in a table in Cleveland *et al.* [6] and more comprehensively in a book by essentially the same authors [7]. In an effort to update the data in this book, a study was conducted by students of Hall at SUNY ESF in 2007 under a grant from the Santa Barbara Family Foundation (available on the oildrum.com), summarized by Heinberg [8]. What follows is a summary of the EROIs of the 12 fuels examined in that study, and updates with other data where available. The data presented in this special issue are considered relative to these earlier studies in the final paper in this special issue.

2. EROI for Oil and Gas

Oil and conventional natural gas are usually studied together because they often occur in the same fields, have overlapping production operations and data archiving. The SUNY ESF study was not able

to update the earlier EROI numbers for oil and gas beyond one additional study by Cleveland [16]. This study gave values similar to those reported in the earlier Cleveland and Hall studies: The EROI for producing oil and gas was roughly 30:1 in the 1950s which declined irregularly to 20:1 in the 1970s and 11–18:1 in the mid 2000's. An additional finding of oil in these studies was that the EROI tended to decline when drilling rates were higher, and increase when drilling was relaxed. These two trends, a secular decline and a secondary response to drilling intensity together explained most (about 92 percent in one analysis) of the variability in oil production. There have now been updates to these analyses for the U.S. until the present issue (See Guilford *et al.*, this volume). The first study for the EROI of global oil and gas resources appears to be Gagnon *et al.* [17].

Precise calculations on the energy inputs required by the global (or any) petroleum industry are difficult to produce due to limited data. Unfortunately, few countries make such information public or ensure quality control where available [8,17]. As a result, Gagnon *et al.* had to estimate energy costs by calculating the energy equivalent per dollar spent (*i.e.*, the energy intensity) in the petroleum industry (or that portion publically traded) using various methods to estimate the energy intensity from fairly good data for the U.S. and the U.K. [17]. They found that about 20 MJ were used for each 2005 dollar spent for both countries, and concluded that global oil and gas EROI was approximately 26:1 in 1992, increased to 35:1 in 1999, and declined to 18:1 by 2006 (Figure 1). Thus the EROI for global oil and gas appeared to have a similar declining trend as the U.S. but was from 50 to 100 percent higher at any given time—which makes sense as the U.S. is more thoroughly exploited than the rest of the world. These authors also estimated through linear extrapolation that the EROI for global oil and conventional natural gas could reach 1:1 as soon as about 2022 given alternative input measurement methods (Figure 2). However, the authors also state that given historical EROI trends, the uncertainty for the exact date is large and a linear decline assumes an exponential rise in cost per unit output. An alternative would be a linear increase in cost per unit output which would result in an exponential decline of EROI and thus push back the break-even point. The authors note that although the EROI for gas is likely much higher than that for oil in most cases, due to the difference in energy costs for raising the fuel in a well, EROI is often represented as an average of both fuels for a given field.

We are not aware of any peer-reviewed published studies available on EROI on non-conventional natural gas to date. The unpublished 2007 SUNY ESF study did estimate the EROI for U.S. domestic gas by analyzing data from a random sample of 100 wells in Indiana County, Pennsylvania in a “bottom-up” EROI calculation [18]. The authors estimated that in 2005 the EROI for a gas field in the U.S. is 10:1 although new analysis (in this special issue) by Sell *et al.* gives a considerably higher estimate. Heinberg predicts that these sources will have lower EROIs than conventional gas and as they take over market share in the global energy matrix, the EROI for natural gas could decline dramatically, but we are desperately in need of real analyses on this subject using solid data [8].

Figure 1. All known EROIs for oil and gas production as per about 2008 [17]. These data imply that EROI is declining over time except during periods of relaxed drilling effort, that quality corrections decrease EROI, and that the EROI for global oil and gas is higher than for the U.S. (a) The triangle is a crude estimate for the EROI of U.S. oil and gas *discoveries* in 1930 [6]; (b) Crosses are Cleveland *et al.*'s estimates for the EROI for *production* in the U.S. This paper also gives values for discoveries that are mostly about half those of production, implying a very large decline since 1930 [6]; (c) The dashed line is Cleveland's assessment of U.S. EROI for *production* including a correction for quality (*i.e.*, for the production of higher quality electricity used in production) [16]; and (d) Global oil and gas EROI [17].

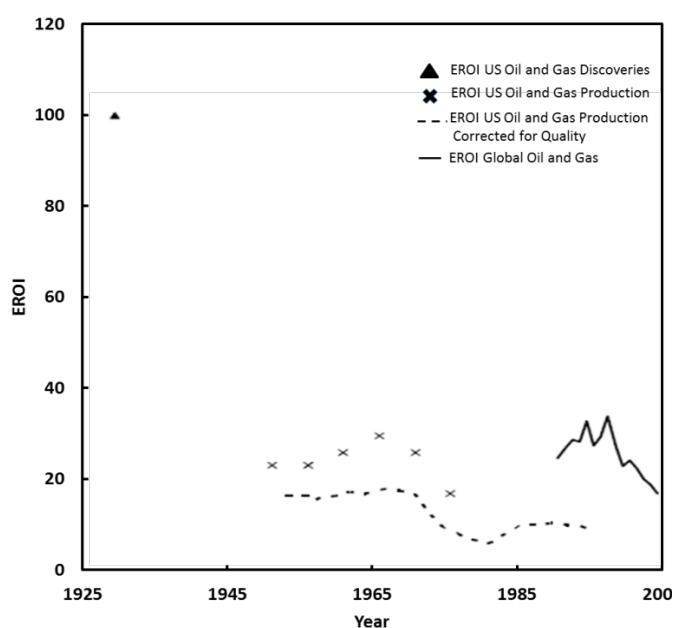

The 2007 SUNY ESF study also estimated the EROI of imported oil to the U.S. This is done differently from a conventional EROI analysis and is different for each importing entity. For the U.S. the EROI of imported oil (crude and refined) is measured not simply as the energy required to bring the oil to the surface as input, or that to transport it to the recipient, but rather as the energy cost of goods and services that must be used to generate the items of trade necessary to generate the foreign exchange (dollars) used to purchase the petroleum, that is to trade for that oil in energy for energy units [19]. Such a calculation also requires the use of energy intensities to convert dollars to energy units. Therefore the authors are again forced to assume that a cost in dollars reflects the cost in energy. This is especially relevant to the subject of imported fuel since the EROI can change dramatically as the relation between the price of oil and the goods and services exported over seas go up and down. A more explicit energy cost was undertaken by Kaufmann in 1986 [7], where he was able to use more specific energy intensities for the major items exported (e.g., the energy cost to produce a dollar's worth of wheat). This was possible because at that time the U.S. federal government maintained more detailed records on the energy used for specific sectors of the economy, and researchers at the University of Illinois were able to derive much more explicit energy intensities (e.g., Hannon [20]). When the values derived in the Palcher *et al.* study were compared to Kaufmann's

more explicit, and presumably more accurate studies, the values had a similar pattern over time and were usually quite similar, except for 1969–1974, when the Palcher *et al.* estimates were about 50 percent higher than Kaufmann's. The reasons for this discrepancy are unknown (Figure 3).

Figure 2. A linear extrapolation of trends in EROI for global oil and gas production [17]. (a) Also shown are linear extrapolations of the steepest and most gradual trends in EROI resulting from different methods of calculating energy input (dashed lines). These were obtained by calculating energy input using energy intensity defined as energy use per real (2005) dollar of gross product of the oil and gas extraction sector with a unique energy intensity for each year (steep slope), and using the average energy intensity over all years (gradual slope).

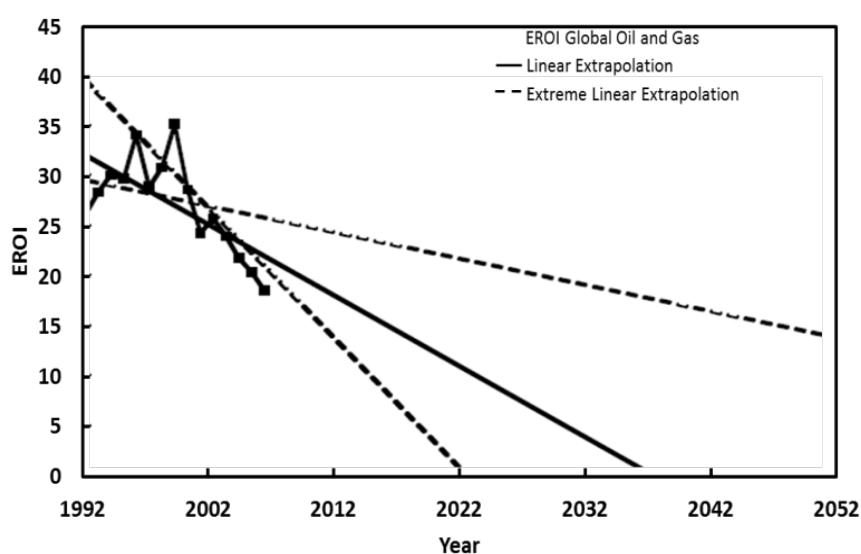
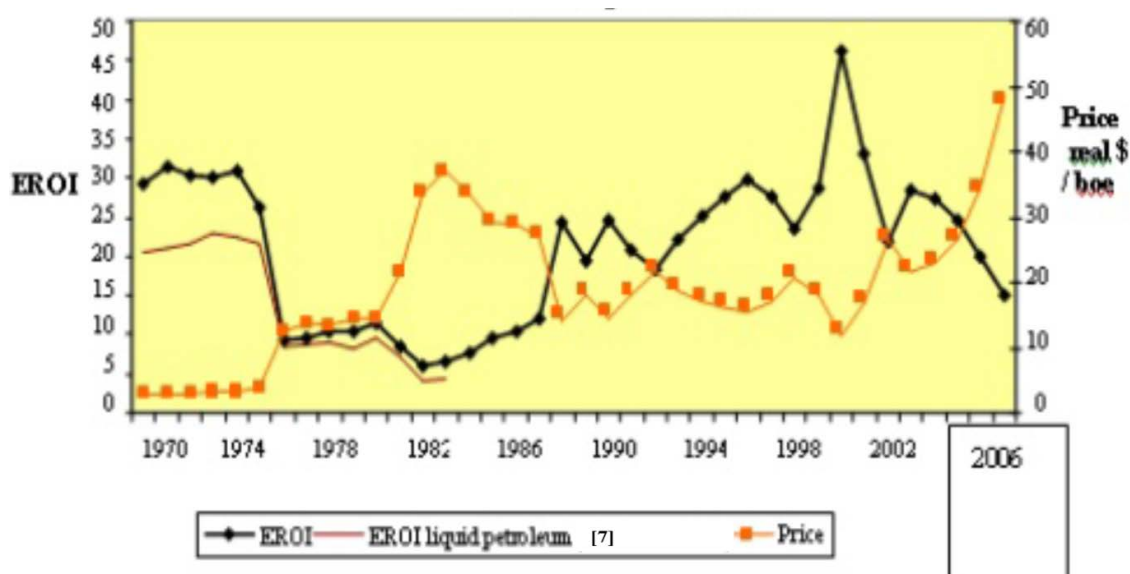

Figure 3. EROI for Imported Crude Oil to the U.S. [19]



The authors of this EROI study note that they exclude the interest paid on debts to purchase foreign oil. Including that cost presumably would decrease EROI. As can be expected, the EROI of imported oil to the U.S. is mostly a reflection of the price of oil relative to the price of general goods and services at that time (Figure 3).

3. EROI for Coal

Unfortunately, the 2007 SUNY ESF study did not include coal. However, there are previous studies that give some values. The first of these was conducted by Hall and Cleveland [5] and Hall *et al.* [7]. They calculated the EROI of U.S. coal including estimates of capital structure, labor, and transportation from 1930 to the late 1970's and found that it was relatively constant at approximately 30:1 until the 1960's when it increased to approximately 35:1, and then fell during the 1970's to less than 20:1. The rise in EROI during the 1960's is attributed to increased extraction efficiency as production shifted to Western surface coal, whereas the drop in EROI during the 1970's is attributed mostly to a decline in the quality of coal being mined in the U.S.

A subsequent study by Cleveland yielded similar patterns over time although the EROIs are much higher [21]. Cleveland calculated the EROI of coal using thermal equivalents, and also quality-corrected values. His thermal equivalent values for EROI are approximately 3 times higher than those of Hall *et al.* [7], perhaps due to a difference in energy accounting methods and system boundaries. Cleveland found that the EROI of U.S. coal fell from about 100:1 during the 1960's to approximately 50:1 and then began to increase to higher than approximately 70:1 by 1987. The quality-corrected values are 4 times lower. There is no information on the EROI of coal beyond 1987 that we know of. However some assumptions can be made. For the U.S. there are forces driving down the EROI into the future. Bituminous coal hit its production peak in about 1992 and has been gradually declining in quality (BTUs per ton) since the 1950's [7]. Also, increased environmental regulations on the industry would have negative impacts on EROI. Forces driving the EROI of coal up include the growing trend of moving from underground mining to surface mining, and other gains in extraction efficiencies. It is not clear whether over time the decline in resource quality would be greater or less than the increased impact of technology. A problem here, too, is a great decline in the quality of data maintenance by the federal government.

4. EROI for Tar Sands

Tar sands, or oil sands, consist of bitumen embedded in sand or clay. It is similar to conventional oil except that it was formed without a geological cap, and thus is not sufficiently "cooked" geologically. It can be liquefied underground through the injection of steam, or mined at the surface, and then processed into liquid fuel called syncrude. The largest producers of syncrude are Canada and Venezuela. The reserves are enormous, but the extraction rate is limited by environmental and other constraints.

The 2007 SUNY ESF study used a "bottom up" approach to calculate the EROI [22]. The calculation is slightly different from other fuels since the source of fuel for syncrude production is the syncrude itself. The system boundaries are limited to the extraction, separation, and upgrading processes. Indirect costs, labor and environmental considerations were calculated by converting dollar costs per barrel to energy costs.

The authors calculate an EROI of about 6:1 that is based mostly upon the direct energy costs of producing syncrude. Including indirect inputs reduced the EROI to about 5:1, and including the energy equivalent of environmental impacts and labor had only a marginal effect. Previous studies reported by Herweyer and Gupta calculated EROIs lower than their results, in the vicinity of 3:1. Reasons for the differences include different energy accounting methods or data, and most likely, gains in process efficiency realized since the earlier studies. Also, syncrude production is not only very energy intensive, but also a large consumer of water, which could also have a negative impact on EROI.

In 2009 a preliminary study posted on The Oil Drum calculated the EROI of producing syncrude from the new Toe to Heel Air Injection (THAI) method as about 9:1, with a range of 3.3–56:1 given different assumptions on the relevance of inputs [23]. Murphy's best estimate of 9:1 is higher than that for the syncrude production processes considered previously by Herweyer and Gupta. This is most likely due to the smaller quantities of natural gas and water necessary in the THAI process.

5. EROI for Shale Oil

Shale oil is similar to tar sands in some ways—both are very low quality resources of petroleum. Whereas tar sands are bitumen surrounding a substrate such as clay or sand with a layer of water in between, shale oil consists of kerogen fused directly to the substrate itself. If tar sands can be thought of as “undercooked” petroleum, shale oil is that which is “overcooked.” As it is more difficult to separate the kerogen from a substrate than to separate bitumen from water, it is expected that the EROI for shale oil should be lower than that of tar sands simply from a chemical point of view.

The SUNY ESF study did not calculate the EROI of shale oil. Instead it reviewed a number of studies from 1975 up to 2007 which had made some kind of EROI or net energy assessment [24]. Most of these studies gave EROIs for shale oil from 1.5–4:1. A few earlier studies suggested an EROI of 7:1 to 13:1. More recent analyses of the “Shell technique,” an approach meant to be relatively environmentally benign and currently in operation, gave estimates of about 3–4:1, although since most of the inputs are electricity and the output is oil one might think that a quality-corrected analysis would lead to near 1:1 [25]. In general, these numbers are in the same range and with the same degree of uncertainty as tar sands. Also, both are unique in that the resource can be used to fuel its own extraction. Although the authors suggest that other technologies are available to producing shale oil, there are no other field tested operations available to calculate EROI.

6. EROI for Nuclear

Nuclear power is the use of controlled fission reactions for the purpose of producing electricity. There are currently 439 commercial nuclear power plants worldwide generally using variations of the same technology [8]. The SUNY ESF study summarized the EROI of nuclear power from previous studies [26]. The review concludes that the most reliable information is still from Hall *et al.*'s [7] summary of an EROI of about 5–8:1 (with a large part of the variability depending upon whether the electricity is corrected for quality), and that the newer studies appear either too optimistic or pessimistic with reported EROIs of up to almost 60:1, to as low as even less than 1:1. Clearly with reactors operating for longer periods of time, with the possibility of serious uranium shortages with

larger use, and with the new considerations of the Japanese reactor accidents due to the earthquake and subsequent tsunami new calculations are needed.

The authors note that the differences in EROI can sometimes be attributed to differences in system boundaries and technologies. However, overall there is a lack of empirical information on the subject. The three major drivers of nuclear EROI are the enormous upfront costs of capital required, environmental costs, and the grade of uranium ore available. At present, much of the ore is secured from dismantled warheads; a return to seriously depleted geological deposits could constitute a decrease in EROI in the future. On the other hand there are possible new, but untested, technologies using smaller reactors or even thorium that might lead to safer and higher EROI reactors.

7. EROI for Wind

Wind energy is one of the fastest growing renewable energies in the world today, although it still represents far less than one percent of global or U.S. energy use. Since it is renewable energy, EROI is not calculated the same as for finite resources. The energy cost for such renewable systems is mostly the very large capital cost per unit output and the backup systems needed, for two thirds of the time the wind is not blowing. As a result, the input for the EROI equation is mostly upfront, and the return over the lifetime of the system—which largely is not known well. For renewable resources a slightly different type of EROI is often used, the “energy pay back time” (EPBT). EPBT is the time it takes for the system to generate the same amount of energy that went into creating, maintaining, and disposing of it, and so the boundaries used to define the EPBT are those incorporated into the EROI.

Although the SUNY ESF study did not calculate EROI for wind they were able to use a recent “meta-analysis” study by Cleveland and Kubiszewski [27]. In this study the authors examined 112 turbines from 41 analyses of both conceptual and operational nature. The system boundaries included the manufacture of components, transportation of components to the construction site, the construction of the facility itself, operation and maintenance over the lifetime of the facility, overhead, possible grid connection costs, and decommissioning where possible, however not all studies include the same scope of analysis. The authors concluded that the average EROI for all systems studied is 24.6:1 and that for all operational studies is 18.1:1. The operational studies provide lower EROIs because the simulations run in conceptual models appear to assume conditions to be more favorable than actually experienced on the ground.

The authors found that the EROI tends to increase with the size of the turbine. They conclude that there are three reasons for this. First, that smaller turbines are of older design and can be less efficient, so despite a larger initial capital investment larger systems compensate with larger energy outputs; second that larger models have larger rotor diameters so they can operate at lower wind speeds and capture more wind energy at higher efficiencies year round; and finally because of their size, larger models are taller and can take advantage of the higher wind speeds farther above ground.

Aspects of wind energy which can lower the EROI include the location of manufacture and installation but have greater construction and maintenance costs as they can add to the initial capital investment of a wind turbine or limit the use of recycled materials. Also, energy storage and grid connection dynamics could potentially reduce EROI where applicable. Finally off shore systems would experience more reliable winds but have greater maintenance costs associated with them.

8. EROI for Photovoltaics

The use of Solar photovoltaics (PV) are increasing almost as rapidly as wind systems, although they too represent far less than 1 percent of the energy used by the U.S. or the world. Similarly, they are a renewable source of energy and thus the EROIs are also calculated using the same idea. Although there are very few studies which perform “bottom up” analysis of the PV systems we are familiar with today, we can calculate the EROI by dividing the lifetime of a module by its energy payback time (EPBT). Like wind turbines, PV EPBT can vary depending on the location of production and installation. It can also be affected by the materials used to make the modules, and the efficiency with which it operates - especially under extreme temperatures.

The SUNY ESF study looked at a number of life cycle analyses from 2000 to 2008 on a range of PV systems to determine system lifetimes and EPBT, and subsequently calculated EROI [28]. The system lifetimes and EPBT are typically modeled as opposed to empirically measured. As a result, EROI is usually presented as a range. Typically the author found most operational systems to have an EROI of approximately 3–10:1. The thin-film modules considered had an EROI of approximately 6:1 whereas some theoretical modules, including a 100MW very large scale PV installation reached or exceeded 20:1. A subsequent study by Kubiszewski *et al.* [29] reviewed 51 systems from 13 analyses and calculated similarly an average EROI of 6.56:1. Much promotional literature gives higher estimates but we are unable to validate their claims. A book in preparation (Prieto and Hall [30]) examines actual energy costs and gains from a series of collectors in Spain and suggests that actual operating EROIs might be considerably less than promoters suggest.

Factors contributing to the increase of EROI include increasing efficiency in production, increasing efficiency of the module, and using materials that are less energy intensive than those available today. Factors contributing to lower EROI include lower ore grades of rare metals used in production (from either depletion in the ground or competition from other industries) and lower than projected lifetimes and efficiencies, problems with energy storage, and intermittence.

The SUNY ESF study also examined passive solar heating and cooling for buildings [31]. A passive solar building is one which captures and optimizes the heat and light available from the sun without the use of any collectors, pumps or mechanical parts, but by design. Unfortunately, passive solar is incredibly site specific and thus calculating an EROI can be very difficult. However, the author does explain how a calculation could be achieved by performing the same operations as those for other renewable forms of energy—lifetime of structure divided by the EPBT. The EROI for a well designed building certainly has the potential to be quite favorable.

9. EROI for Hydropower

Hydropower plants vary greatly in size and scope, and thus so does the energy output and necessary inputs required to build and maintain facilities. Large scale hydropower projects, usually involving reservoirs, are the best researched. Although there is much room for further hydropower installation worldwide, there are only limited areas in the U.S. for further development. For hydropower, the EROI is calculated the same as other renewable sources of energy, where the total energy output over the lifetime of the station is divided by the energy costs of creating and maintaining it. It is unclear if decommissioning sites are part of the analysis, which would lower the EROI.

The SUNY ESF study reviewed previous studies on specific installations [32]. EROI figures examined by the author ranged from 11.2–267:1 due to the extreme variability of geography and technology. The author noted that environmental and social costs, which can be substantial, are not incorporated in the numbers. Since all these costs and gains are site sensitive, it is clear that determining an overall EROI for hydropower would be meaningless and that each project would need to be examined separately. Yet, given the range of EROIs in the study, it seems that hydropower, where available, is often a good energy return on investment.

10. EROI for Geothermal

Geothermal energy uses the heat within the Earth to do work by transferring the heat to a gas such as steam, or a liquid. This can be used to produce electricity or heat for buildings etc. The best suited sites are near plate boundaries and as such are not available to everyone. Currently, only hydrothermal resources are being utilized for commercial energy. These are where heat is transferred to groundwater at drillable depths. Enhanced geothermal systems also known as Hot Dry Rock (HDR) are thought to be able to exploit heat at greater underground depths where there is no groundwater although there are none in commercial use. Another theoretical system called geopressed geothermal could provide thermal energy from hot brine, mechanical energy from highly pressured fluid, and chemical energy from confined methane, but the specifics for such systems are unknown. In fact there is no consensus on resource base estimates for geothermal energy.

The SUNY ESF study calculated the EROI for HDR geothermal systems and reviewed previous studies on hydrothermal resources from 1975–1991 [33]. The EROI for electricity generation from hydrothermal resources was reported with a range of 2–13:1. Corrected for quality as an electricity source, this is recalculated as approximately 6–39:1. Some theoretical EROI values have been calculated for HDR ranging from 1.9–13:1 or 5.7–39:1 when quality corrected, and for geopressed systems with a range of 2.9–17.6:1. The author attributes the large ranges to a lack of a unified methodology for EROI analysis and disagreements about system boundaries, quality-correction, and future expectations. No EROI values of geothermal direct use were found. Energy can be extracted from normal soils and ground water with an EROI of about 5:1, although the input is electricity and the output heat so the quality corrected output may not be very high.

11. EROI for Wave/Tidal

There is very little information available on wave or tidal energy due to its fledgling state in commercial application. Despite ongoing research and projects, attaining an EROI on wave or tidal energy systems is very difficult due to the small scale of the industry and also the fact that these systems are very site specific. The SUNY ESF study estimated that one wave energy project could have an EROI of approximately 15:1 [34]. This number was estimated based on a life cycle assessment of the Pelamis off-shore device currently deployed outside of Portugal. A problem is that it is difficult to maintain many devices when large storms occur.

12. EROI for Corn Ethanol

The debate over the EROI for corn ethanol is probably the most documented of all the energy sources presented here. Most of the often rancorous literature has been about whether corn ethanol requires more energy than it uses (*i.e.*, EROI of <1:1) or whether it is positive, if low. The EROI of the numerous studies available on the subject range from approximately 0.8:1 to 1.3–2:1 [35]. The difference in values is mostly attributed to boundaries used and energy quality issues. This issue is explored in more detail in the paper by Hall, Dale and Pimentel in this special Journal issue.

In one recent study, Murphy *et al.* demonstrate that it cannot be statistically determined if the EROI for corn ethanol is above or below zero with any confidence, and that the largest impact on EROI is from co-products of the energy producing system, not yields of corn [35]. They also state that when Iowa is used as a benchmark for growing conditions and expected yields, the EROI is likely to be on the lower side of the scale given that Iowa represents the best conditions in the U.S. These authors conclude that the energy gains, if any, from corn ethanol are negligible without co-product credit.

13. Discussion

There has been a surprisingly small amount of work done in the field of EROI calculation despite its obvious uses and age. From this review it can be inferred that there are only a handful of people seriously working on the issues related to energy return on investment. As such it does not come as a surprise that the information is scarce and unrefined at best—although perhaps not in the case of ethanol. Additionally there is a great deal of rather misleading material presented in the media and very few with the training to cut through the fog or deliberate lies. We have presented what we believe to be virtually all of the data available until this special issue.

Since the 1980's the energy information required to make such calculations have become even scarcer, with the possible exception of some European life cycle analyses. This is a terrible state of affairs given the massive changes in our energy situation unfolding daily. We need to make enormously important decisions but do not have the studies, the data or the trained personnel to do so. Thus we are left principally with poorly informed politicians, industry advocacy and a blind but misguided faith in market solutions to make critical decisions about how to invest our quite limited remaining high quality energy resources. Our major scientific funding agencies such as the National Science Foundation and even the Department of Energy have been criminally negligent by avoiding any serious programs to undertake proper EROI, environmental effects, or other studies, while our federal energy data collections degrade year by year under misguided cost cutting and free market policies.

As stated by Murphy and Hall [15], there needs to be a concerted effort to make energy information more transparent to the people so we can better understand what we are doing and where we are going. Given what we do know, it seems that the EROI of the fuels we depend on most are in decline; whereas the EROI for those fuels we hope to replace them with are lower than we have enjoyed in the past. This leads one to believe that the current rates of energy consumption per capita we are experiencing are in no way sustainable in the long run. At best, the renewable energies we look toward may only cushion this decline.

Acknowledgments

We would like to acknowledge the help of our reviewers in refining the information available here. Specifically we would like to thank Robert Kaufmann for his insights into extrapolating EROI into the future. We would also like to thank the members of the SUNY ESF research team for undertaking the task of accumulating much of this scarce information. The original results are reported in The Oil Drum website (www.theoil Drum.com) and in a summary by Richard Heinberg. Finally we would like to thank the Santa-Barbara Family Foundation for providing the funding for that research, and the UK Department for International Development (DFID) and Tullet Prebon for recent support.

Conflict of Interest

The authors declare no conflict of interest.

References and Notes

- Hall, C.A.S. Migration and metabolism in a temperate stream ecosystem. *Ecology* **1972**, *53*, 585-604.
- Lee, R. Kung bushman subsistence: An input-output analysis. *Environ. Cult. Behav.* **1969**, 47-79.
- Georgescu-Roegen, N. Energy and economic myths. *South. Econ. J.* **1975**, *41*, 347-381.
- Odum, H.T. *Environment, Power and Society*; Wiley InterScience: New York, NY, USA, 1973.
- Hall, C.; Cleveland, C. Petroleum drilling and production in the United States: Yield per effort and net energy analysis. *Science* **1981**, *211*, 576-579.
- Cleveland, C.J.; Costanza, R.; Hall, C.A.S.; Kaufmann, R. Energy and the U.S. economy: A biophysical perspective. *Science* **1984**, *225*, 890-897.
- Hall, C.; Cleveland, C.; Kaufmann, R. *Energy and Resource Quality: The Ecology of the Economic Process*; Wiley-InterScience: New York, NY, USA, 1986.
- Heinberg, R. Searching for a Miracle: Net energy limits and the Fate of Industrial Societies. A Joint Project of the International Forum on Globalization and Post Carbon Institute. In *False Solutions Series #4*; Post Carbon Institute: Santa Rosa, USA, 2009.
- Hall, C.; Klitgaard, K. The need for a new, Biophysically-based paradigm in economics for the second half of the age of oil. *Int. J. Transdiscipl. Res.* **2006**, *1*, 4-22.
- Hall, C. Why EROI Matters (Part 1 of 6). The Oil Drum, 2008, Available online: <http://www.theoil Drum.com/node/3786> (accessed on 1 June 2011).
- Mearns, E. Oil production and energy return on investment (EROI). www.sindark.com: Ottawa, Canada, 2008; Available online: <http://www.sindark.com/2008/08/23/oil-production-and-energy-return-on-investment-eroi/> (accessed on 1 June 2011).
- Day, J.W., Jr.; Hall, C.A.; Yanez-Arancibia, A.; Pimentel, D.; Marti, C.I.; Mitch, W.J. Ecology in times of scarcity. *BioScience* **2009**, *59*, 321-331.
- Hall, C.A.S.; Balogh, S.; Murphy, D.J.R. What is the minimum EROI that a sustainable society must have? *Energies* **2009**, *2*, 25-47.
- Hall, C.A.S.; Day, J.W., Jr. Revisiting the limits to growth after peak oil. *Am. Sci.* **2009**, *97*, 230-237.
- Murphy, D.J.R.; Hall, C.A.S. Year in review—EROI or energy return on (energy) invested. *Ann. N.Y. Acad. Sci.* **2010**, *1185*, 102-118.

16. Cleveland, C.J. Net energy from oil and gas extraction in the United States, 1954–1997. *Energy* **2005**, *30*, 769–782.
17. Gagnon, N.; Hall, C.A.S.; Brinker, L. A preliminary investigation of energy return on energy investment for global oil and gas production. *Energies* **2009**, *2*, 490-503.
18. Button, S.; Sell, B. Appendix C: Natural Gas: Potential, EROI and Social and Environmental Impacts. The Oil Drum, 2008; Available online: <http://www.theoil Drum.com/node/3810> (accessed on 1 June 2011).
19. Palcher, S.; Herweyer, M.C.; Hall, C.A.S. Appendix B: Crude and refined oil imported to the United States. The Oil Drum, 2008; Available online: <http://www.theoil Drum.com/node/3810> (accessed on 1 June 2011).
20. Hannon, B. Analysis of the energy cost of economic activities: 1963–2000. **1982**, *6*, 249-278.
21. Cleveland, C.J. Energy quality and energy surplus in the extraction of fossil fuels in the U.S. *Ecol. Econ.* **1992**, *6*, 139-162.
22. Herweyer, M.C.; Gupta, A.K. Appendix D: Tar Sands/Oil Sands. The Oil Drum, 2008; Available online: <http://www.theoil Drum.com/node/3839> (accessed on 1 June 2011).
23. Murphy, D.J.R. EROI Update: Preliminary Results using Toe-to-Heel Air Injection. The Oil Drum, 2009; Available online: <http://netenergy.theoil Drum.com/node/5183> (accessed on 1 June 2011).
24. Gupta, A.K.; Herweyer, M.C.; Hall, C.A.S. Appendix E: Oil Shale: Potential, EROI and Social and Environmental Impacts. The Oil Drum, 2008; Available online: <http://www.theoil Drum.com/node/3839> (accessed on 1 June 2011).
25. Shell Frontier Oil and Gas. Oil Shale Test Project. Oil Shale Research and Development Project 2006-02-15. Shell Frontier Oil and Gas Inc.: Boulder, USA, 2006; Available online: www.blm.gov/pgdata/etc/medialib/blm/co/field_offices/white_river_field/oil_shale.Par.79837.File.dat/OSTPlanofOperations.pdf (accessed on 1 June 2011).
26. Powers, R. Appendix F: Nuclear Electricity: Potential, EROI and Social and Environmental Impacts. The Oil Drum, 2008; Available online: <http://www.theoil Drum.com/node/3877> (accessed on 1 June 2011).
27. Cleveland, C.J.; Kubiszewski, I. Energy Return on Investment (EROI) for Wind Energy. Publisher: The Oil Drum, 2008; Available online: <http://www.theoil Drum.com/node/1863> (accessed on 1 June 2011).
28. Gupta, A.K. The Energy Return of (Industrial) Solar - Passive Solar, PV, Wind and Hydro (#5 of 6): Appendix G-2. The Oil Drum, 2008; Available online: <http://www.theoil Drum.com/node/3910> (accessed on 1 June 2011).
29. Kubiszewski, I.; Cleveland, C.; Szostak, R. Energy return on investment (EROI) for photovoltaic energy. The Encyclopedia of Earth: Boston, USA, 2009; Available online: [http://www.eoearth.org/article/Energy_return_on_investment_\(EROI\)_for_photovoltaic_energy](http://www.eoearth.org/article/Energy_return_on_investment_(EROI)_for_photovoltaic_energy) (accessed on 1 June 2011).
30. Prieto, P.; Hall, C.A.S. *Net Energy from Photovoltaics in the Spanish Electricity Grid*; Springer: New York, NY, USA, In Preparation.
31. Giermek, K. The Energy Return of (Industrial) Solar-Passive Solar, PV, Wind and Hydro (#5 of 6): Appendix G-1. The Oil Drum, 2008; Available online: <http://www.theoil Drum.com/node/3910> (accessed on 1 June 2011).

32. Schoenberg, B. The Energy Return of (Industrial) Solar—Passive Solar, PV, Wind and Hydro (5 of 6): Appendix G. The Oil Drum, 2008; Available online: <http://www.theoil Drum.com/node/3910> (accessed online 1 June 2011).
33. Halloran, D. Appendix H: Geothermal Energy Summary. The Oil Drum, 2008; Available online: <http://www.theoil Drum.com/node/3949> (accessed on 1 June 2011).
34. Halloran, D. Appendix I: Wave Energy: Potential, EROI, and Social and Environmental Impacts. The Oil Drum, 2008; Available online: <http://www.theoil Drum.com/node/3949> (accessed on 1 June 2011).
35. Murphy, D.J.R.; Hall, C.A.S.; Powers, B. New perspectives on the energy return on (energy) investment (EROI) of corn ethanol. *Environ. Dev. Sustain.* **2010**, *13*, 179-202.

© 2011 by the authors; licensee MDPI, Basel, Switzerland. This article is an open access article distributed under the terms and conditions of the Creative Commons Attribution license (<http://creativecommons.org/licenses/by/3.0/>).

Article

A Dynamic Function for Energy Return on Investment

Michael Dale ^{1,*}, Susan Krumdieck ¹ and Pat Bodger ²

¹ Advanced Energy and Material Systems (AEMS) Lab, Department of Mechanical Engineering, University of Canterbury, Christchurch 8041, New Zealand;

E-Mail: susan.krumdieck@canterbury.ac.nz

² Electrical and Computer Engineering, University of Canterbury, Christchurch 8041, New Zealand;

E-Mail: pat.bodger@canterbury.ac.nz

* Author to whom correspondence should be addressed; E-Mail: mikdale@stanford.edu;

Tel.: +1-650-384-3543.

Received: 1 November 2010; in revised form: 1 January 2011 / Accepted: 1 February 2011 /

Published: 17 October 2011

Abstract: Most estimates of energy-return-on-investment (EROI) are “static”. They determine the amount of energy produced by a particular energy technology at a particular location at a particular time. Some “dynamic” estimates are also made that track the changes in EROI of a particular resource over time. Such approaches are “bottom-up”. This paper presents a conceptual framework for a “top-down” dynamic function for the EROI of an energy resource. This function is constructed from fundamental theoretical considerations of energy technology development and resource depletion. Some empirical evidence is given as corroboration of the shape of the function components.

Keywords: EROI; net energy; energy-return-on-investment

1. Introduction

Energy is fundamentally important to all of the processes that occur within our modern, (post)industrial society. It has been famously described by James Clerk-Maxwell as, “the ‘go’ of things” [1]. Modern society currently uses around 500 exajoules (1 EJ = 10¹⁸ J) of primary energy, 85% of which comes from fossil fuels. Some proportion of this 500 EJ must be used in the extraction and processing of energy resources, as well as in the manufacture of energy technology infrastructure,

such as oil rigs and dams for hydroelectricity. This paper is intended as a discussion piece regarding some of the conceptual issues surrounding long-term dynamics of the energy supply system which may be understood using the dynamic EROI function.

1.1. Energy Analysis

Energy analysis is the process of measuring the energy flows through the process or system under investigation. According to Boustead and Hancock [2], “Energy analysis is a technique for examining the way in which energy sources are harnessed to perform useful functions” Peet [3] classifies energy analysis as, “determination of the amount of primary energy, direct and indirect. that is dissipated in producing a good or service and delivering it to the market” reflecting the current focus of energy analyses on economic activities. Energy analysis is important for a number of reasons:

- firstly, because of the adverse environmental impacts linked with energy transformation processes, especially of concern recently being the emission of greenhouse gases associated with the combustion of fossil fuels (possible solutions include carbon capture and storage (CCS), however the increased energy consumption entailed by CCS may (dis)favor certain methods of energy production);
- secondly, because of the finite availability of fuels and other energy resources (whereas non-renewable resources are finite in terms of total quantity, renewable resources are finite in the magnitude of their flow) and;
- thirdly, because of the strong link between net energy and the material standard of living and economic opportunity offered by a society [4].

There is evidence that the qualities (*i.e.*, net energy returns) of the major energy sources in use by society (coal, oil and gas) are declining [5]. *Ceteris paribus*, a decline in EROI of energy resources will increase the environmental impacts of an energy production process. Also, since more energy must be extracted to deliver the same amount of net energy to society this will entail faster consumption of finite energy resources. A society dependent on energy resources with lower EROI must also commit relatively more energy to the process of harnessing energy, hence has less available for other economic activities.

1.1.1. Net Energy and EROI

Whereas standard econometric energy models, such as MESSAGE [6], MARKAL [7] and the IEA’s WEM [8], account only for gross production by the energy sector, P, net energy analysis (NEA) considers all energy flows between the energy sector and the rest of the economy, as depicted in Figure 1. The energy sector receives two inputs from the rest of the economy in order to produce energy. Inputs in the form of energy, S_1 enable the energy sector to run its equipment, *i.e.*, process energy. Inputs in the form of human-made-capital (HMC), S_2 , are the physical plant that must be put in place in order to extract energy from the environment, e.g., oil wells, wind turbines, hydro dams, *etc.*

Figure 1. Energy and material flows between the energy sector and the main economy based on diagram from [4]. Bold lines represent energy flows, dotted lines represent material flows and dashed lines represent monetary flows.

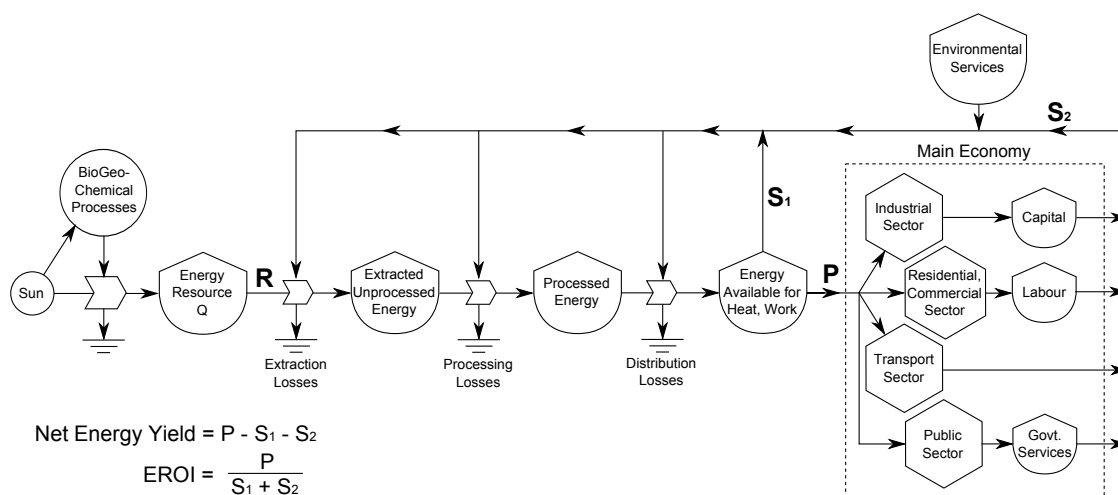

In order to determine the net energy yield or benefit (the gross energy production less energy needs for extraction and processing), $P - (S_1 + S_2)$, the ratio of energy produced to the energy needed to obtain this yield, $P/(S_1 + S_2)$ is known as the net energy ratio (NER) or energy-return-on-investment (EROI) [9].

A reduction in net energy yield may occur for one of three reasons:

1. the energy flow rate of the resource is declining, such as due to an increase in the water production of an oil field;
2. more energy is required to extract the resource, such as oil extraction by pumping down steam or gas during enhanced oil recovery (EOR) or;
3. both 1 and 2 are occurring simultaneously.

In all cases the amount of energy required to produce a unit of energy output increases. This greater energy requirement will either be made up by utilizing energy flows from within the same energy production process (internal), such as an oil producer using oil from the field to produce steam for EOR, or from energy flows originating outside of the process (external), such as an oil producer using coal or natural gas for the same purpose [10]. In the latter case, the oil production process may be competing directly with other end-uses for the energy. Many authors have begun questioning the effects that declining EROI values will have on the economy [3–5,11,12].

2. A Dynamic Function for EROI

2.1. Theoretical Considerations

Most estimates of EROI are made as static estimates of a resource at a particular moment in time. The authors have located over 500 such estimates for all of the energy resources currently under development, as well as some still under R & D. Some dynamic estimates have been made which track the EROI of a

particular fossil resource as it changes over time. A number of such studies track the EROI of coal and oil production from various different resources over several decades [4,5,13–16], as depicted in Figures 2 and 3. The studies show that the EROI of most energy resources (coal and oil) has been either (relatively) stable at an EROI of 20–40 or decreasing over time, some from an EROI of over 100. One such study has been conducted by Costanza and Cleveland [17] of oil and gas production in Louisiana. They identify a very characteristic shape for the EROI as a function of cumulative production, as shown in Figure 4. The EROI of the resource initially increases before reaching some point of production, P_{\max} , at which point the energy return is at its maximum value, before declining and eventually dropping below the break-even limit represented by an EROI value of one. In this paper, we offer an explanation for the shape of this curve.

Figure 2. EROI of coal production from a number of studies.

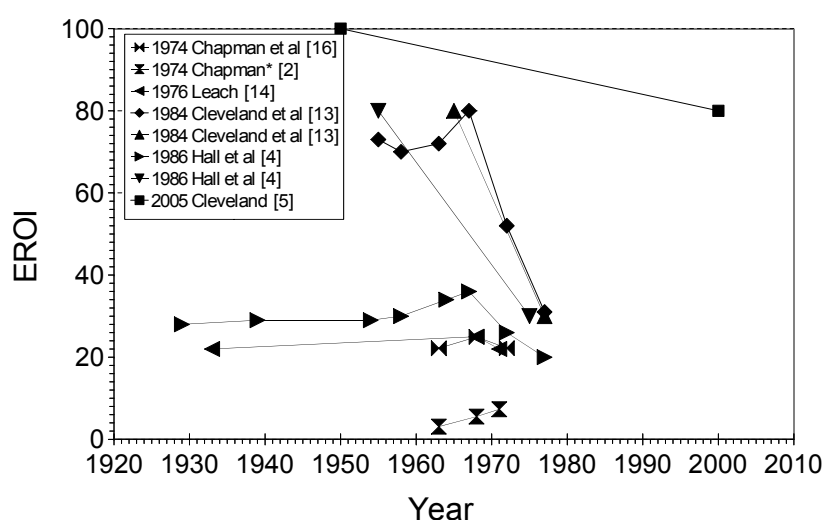

Figure 3. EROI of conventional oil production from a number of studies.

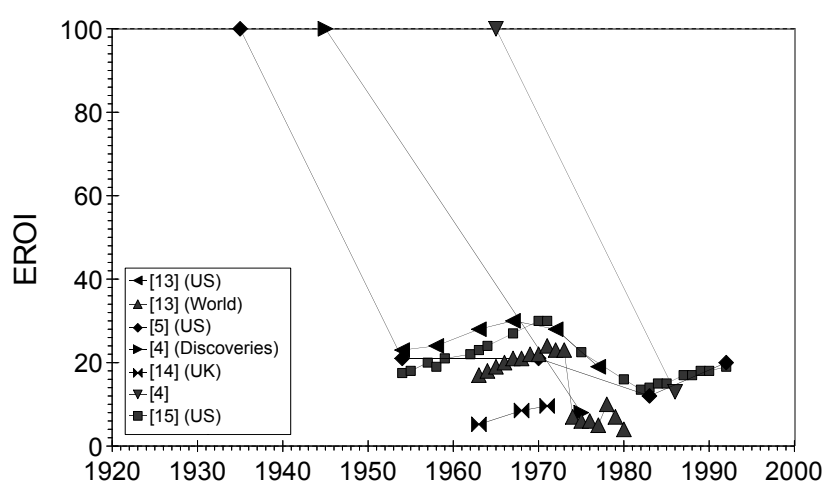
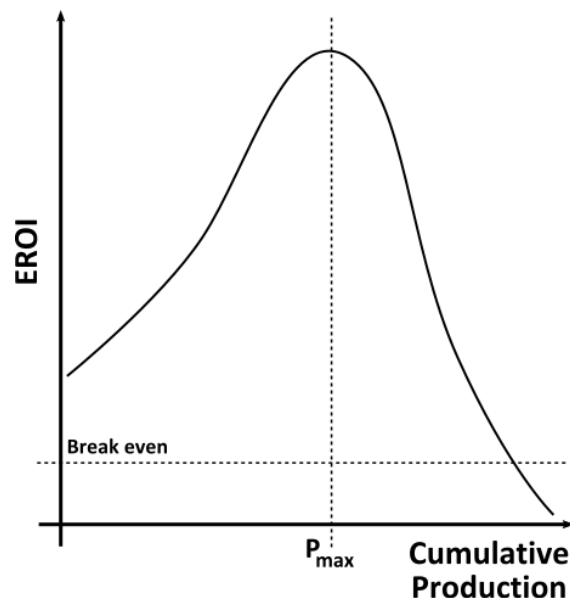
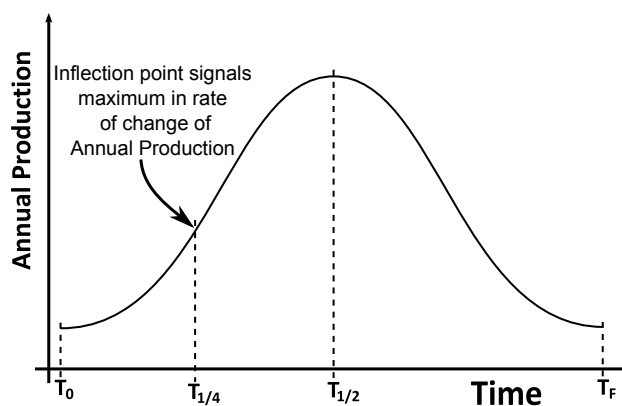

Figure 4. EROI of oil and gas production in Louisiana as a function of cumulative production, from [17].



Assuming that this cycle corresponds with the *production cycle* identified by Hubbert for non-renewable resources [18], at what point in the production cycle will P_{\max} occur? We conjecture that P_{\max} should occur a quarter of the way through the production cycle. Hubbert's curve for annual production, \dot{P} , as shown in Figure 5, initially increases exponentially before reaching a peak and thereafter declining. This curve passes through a point of inflection a quarter of the way through the cycle, corresponding to a maximum in the rate of change of annual production, *i.e.*, the first derivative of annual production with respect to time, \ddot{P} .

Figure 5. Annual production over the entire *production cycle* of a non-renewable resource; the “Hubbert Curve”. If production is symmetric then the maximum change in the annual production occurs at the inflection point at $T_{1/4}$.



The purpose of investment in increasing infrastructure is to buy an increase in annual production, therefore we may say that:

$$\ddot{P} \propto EROI \times Investment \quad (1)$$

Presumably investment in infrastructure increases exponentially (or at the very minimum linearly) between T_0 and $T_{1/2}$. If so, then annual production and capital investment are correlated between T_0 and $T_{1/4}$. Thereafter, each unit of capital investment earns less return in energy production, reflected in the decreasing rate of change of energy production, \dot{P} . Since EROI is the correlating factor between capital investment and energy production, then EROI must be decreasing and, hence, must have peaked before $T_{1/4}$ in the production cycle. This would not be the case if investment were constant (in which case P_{max} would occur when \dot{P} is a maximum) or if investment were decreasing over the period. However, both of these cases seem unlikely.

Within this work, we posit that this curve for the EROI is representative of not only Louisiana oil and gas but all non-renewable resources. We further assume that this EROI function is a product of two components: one technological, G , that serves to increase energy returns as a function of cumulative resource production, which serves as a proxy measure of experience, *i.e.*, technological learning; and the other, H , diminishing energy returns due to declining physical resource quality. The function $F(p)$ is depicted in Figure 6 along with the two components.

$$F(p) = \varepsilon G(p)H(p) \quad (2)$$

Where ε is a scaling factor that increases the EROI and p is cumulative production normalized to the size of the ultimately recoverable resource (URR). Within this work URR is assumed to be the total resource that may be recovered at positive net energy yield. In reality, ε and URR (or TP) would be used as parameters for scenario-based assessment or a Monte Carlo simulation. Normalised cumulative production, p is defined such that:

$$p = \frac{P}{URR}$$

Figure 6. EROI as a function of cumulative production. The (decreasing) physical depletion and (increasing) technological components are shown as dotted lines.

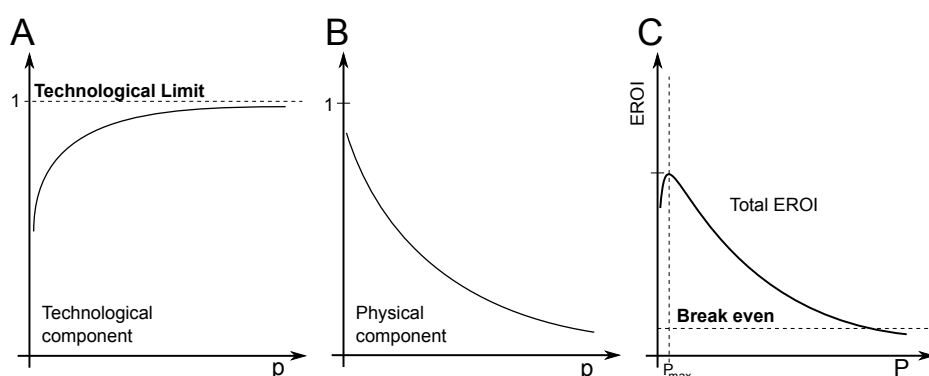

2.2. Technological Component

We assume that the technological component of the EROI function asymptotically increases as a function of production as shown in Figure 6. There are two factors that will influence this technological component of the EROI function: how much energy must be embodied within the equipment used to extract energy and how well that equipment performs the function of extracting energy from the

environment. We assume that both of these factors are subject to strict physical limits. Firstly, that there is some minimum amount of energy that must be embodied in order to function as an energy extraction device, for instance the foundation of a wind turbine must successfully endure a large moment load. Secondly, there is a limit to how efficiently a device can extract energy. We further assume that, as a technology matures, *i.e.*, as experience is gained, the processes involved become better equipped to use fewer resources: PV panels become more efficient and less energy intensive to produce; wind turbines become more efficient and increasing size allows exploitation of economies of scale. These factors serve to increase energy returns. However, it can be expected that these increases are subject to diminishing marginal returns as processes approach fundamental theoretical limits, such as the Lancaster-Betz limit in the case of wind turbines.

Technological learning curves (sometimes called cost or experience curves) track the costs of production as a function of production. These often follow an exponentially declining curve asymptotically approaching some lower limit. The progress ratio specifies the production taken for costs to halve. Between 1976 and 1992, the PV module price per watt of peak power, W_p , on the world market was 82% [19]. This means that the price halved for an increase in cumulative production of 82%. Lower financial production costs should correlate with lower values of embodied energy [4,20,21]. The specific form of the function is:

$$G(p) = 1 - X \exp^{-\chi p} \quad (3)$$

where $0 < X \leq 1$.

Here X represents the initial value of the immature technology and χ represents the rate of technological learning through experience, which will be dependent on a number of both social and physical factors. This rate is assumed constant.

2.3. Physical Depletion Component

The physical resource component of the EROI function is assumed to decrease to an asymptotic limit as a function of production, as shown in Figure 6. In general, those resources that offer the best returns (whether financial or energetic) are exploited first. Attention then turns to resources offering lower returns as production continues. In general the returns offered by an energy resource will depend upon the type of source, formation and depth of the reserve, hostility of the environment, distance from demand centers and any necessary safety or environmental measures. The costs of production often increase exponentially with increases in these factors [22]. The result is that the physical component of the EROI of the resource declines as a function of production. We assume that this decline in EROI, H will follow an exponential decay:

$$H(p) = \Phi \exp^{-\phi p} \quad (4)$$

where $0 < \Phi \leq 1$.

Here Φ represents the initial value of the physical component and ϕ represents the rate of degradation of the resource due to exploitation. Again this rate is assumed constant.

We justify this exponential curve by considering the distribution of energy resources. Some of these resources will offer large energy returns due to such factors as their energy density (e.g., grades of crude or coal), their ease of accessibility (e.g., depth of oil resources, on-shore vs. offshore), their proximity to

demand centers (e.g., Texan vs. Polar oil) and possible other factors. The EROI of one particular source should be, if not normal, then most likely displays a positive skew, *i.e.*, the median is less than the mean, as depicted in Figure 7. For example, there are more sites with lower average wind speeds than with higher wind speeds.

Figure 7. Probability density function and cumulative distribution function for EROI of an energy resource.

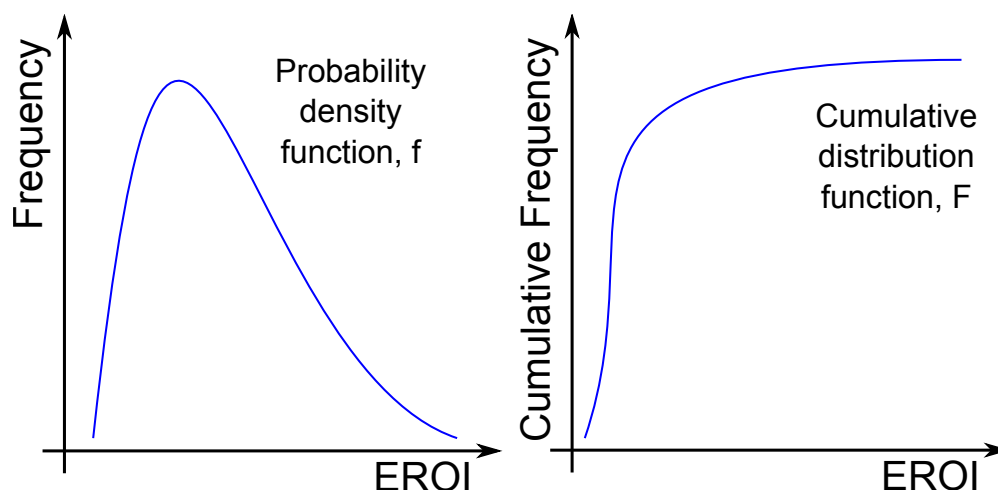

If we now assume that sites will be exploited as a function of their EROI, *i.e.*, that those sites offering the best energy returns are exploited first, then we may now re-plot the cumulative distribution function as EROI depletion as a function of exploitation, *i.e.*, production by rotating the axes and ranking the sites by EROI from highest to lowest.

Figure 8. Decline of EROI of energy resource due to exploitation of best resources.

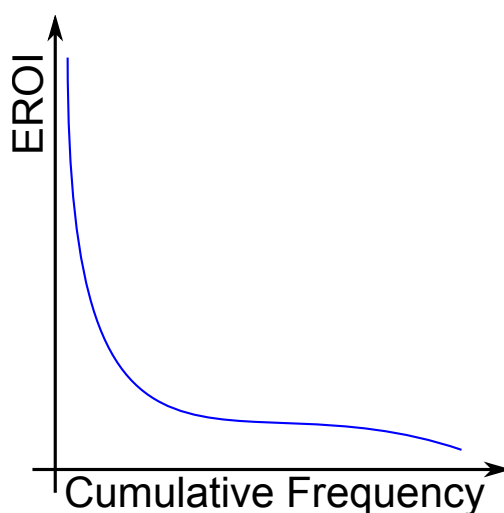

2.4. Finding p_{max}

Since the EROI function for non-renewable resources is assumed to be a well-behaved function, the point p_{max} may be found via differentiation. p_{max} occurs at the value of p at which $\frac{d}{dp}(EROI(P_{max})) = 0$. Using the product rule finds that:

$$\begin{aligned}\frac{d}{dp}EROI &= \frac{d}{dp}[F(p)] = \frac{d}{dp}[\varepsilon G(p)H(p)] \\ &\Rightarrow \varepsilon[G\frac{dH}{dp} + H\frac{dG}{dp}]\end{aligned}\quad (5)$$

Differentiating G and H , gives:

$$\frac{dG}{dp} = X\chi\exp^{-\chi p}\quad (6)$$

$$\frac{dH}{dp} = -\Phi\phi\exp^{-\phi p}\quad (7)$$

Substituting Equations (6) and (7) into Equation (5) obtains:

$$\begin{aligned}(1 - X\exp^{-\chi p_{max}})(-\Phi\phi\exp^{-\phi p_{max}}) + (\Phi\exp^{-\phi p_{max}})(X\chi\exp^{-\chi p_{max}}) &= 0 \\ \Rightarrow X\Phi(\phi + \chi)\exp^{-\chi p_{max}}\exp^{-\phi p_{max}} &= \Phi\phi\exp^{-\phi p_{max}} \\ \Rightarrow X(\phi + \chi)\exp^{-\chi p_{max}} &= \phi\end{aligned}\quad (8)$$

Taking the natural logarithm of Equation (8) obtains:

$$\begin{aligned}\ln(X(\phi + \chi)) - \chi p_{max} &= \ln(\phi) \\ \rightarrow p_{max} &= \frac{\ln(X) + \ln(\phi + \chi) - \ln(\phi)}{\chi}\end{aligned}\quad (9)$$

2.5. The EROI Function for Renewable Resources

Unlike non-renewable sources, for which the EROI is solely a function of cumulative production, in the case of renewable energy sources the physical component of EROI is a function of annual production. The technological component will still be a function of cumulative production, which serves as a proxy measure for experience. In this case a reduction in production means that the EROI may “move back up the slope” of this physical component. In the interim, technology, which is a function of cumulative production, will have increased, further pushing up energy returns. This entails that the EROI of a renewable energy source is a path dependent function of production.

Decline in the physical component of EROI for renewable energy sources represents the likelihood of the most optimal sites being used earliest. For example, deployment of wind turbines presently occurs only in sites where the average wind speed is above some lower threshold and that are close to large

demand centers to avoid the construction of large distribution networks. Over time, the availability of such optimal sites will decrease, pushing deployment into sites offering lower energy returns, which should be reflected in declining capacity factors over time.

3. Discussion

3.1. Supporting Evidence

We provide supporting evidence for the EROI function presented by considering wind and solar resources for the US as a case study. The technological component of the EROI may be increased by the production of wind turbines that are able to better extract energy from the passage of air. This increase is subject to an absolute physical limit represented by the Lancaster–Betz limit [23] which defines the maximum proportion of energy that may be extracted from a moving column of air as $16/27 \simeq 60\%$. Experience curves for wind farms show that long-term costs of energy production from wind have fallen exponentially as a function of cumulative energy production (a proxy for “experience”) [24].

The resource base for wind has been extensively (and intensively) mapped in several regions of the world. The National Renewable Energy Laboratory (NREL) Western Wind Dataset [25] was used to produce a depletion curve of the US wind resource, ranked by power density (W/m^2) shown in Figure 9. The power density of the wind resource initially declines exponentially as a function of land area, before dropping sharply below $500 W/m^2$.

Figure 9. Depletion curve for the wind resource in the United States ranked by power density (W/m^2) as a percentage of total land area. The quality of the wind resource decreases exponentially.

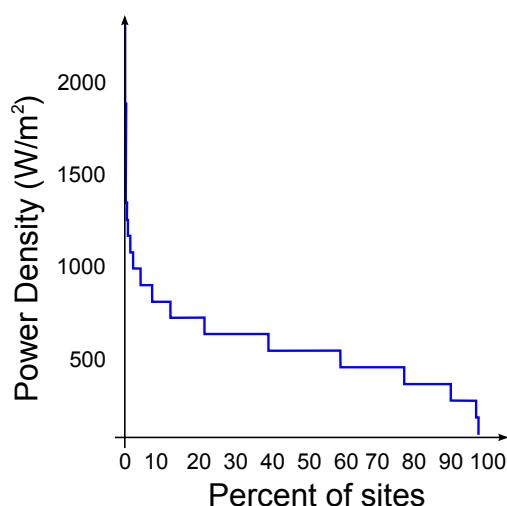

NREL have also produced the National Solar Radiation Database (NSRDB), for the mainland US [26]. This data was used to produce a depletion curve of the US solar resource ranked by energy flux density ($Wh/m^2/day$) shown in Figure 10. The energy flux density of the solar resource declines exponentially as a function of total land area from a maximum of just over $8,000 Wh/m^2/day$.

Figure 10. Depletion curve for the solar resource in the United States ranked by energy flux density ($Wh/m^2/day$) as a percentage of total land area. The quality of the solar resource decreases exponentially.

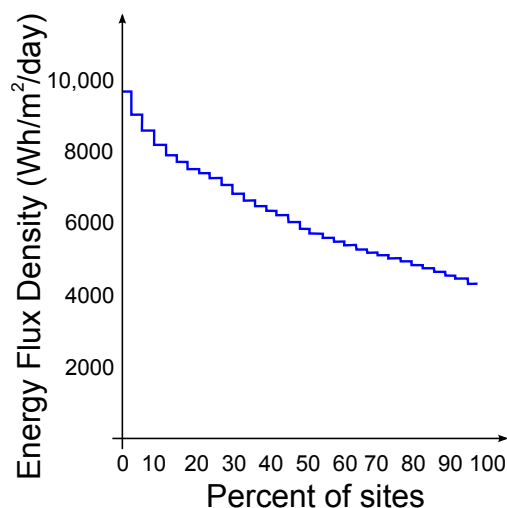

If we imagine the total resource being populated with identical turbines, each with a nominal constant embodied energy cost, κ [GJ/MW] and a nominal lifetime t_L [yr] in such a way as to exploit the best sites first, the pattern of decline of the EROI as a function of total capacity installed [MW], will follow the pattern of the power density of the sites. An analogous case may be made of the solar resource.

Brandt (in press) [10] has made a long-term study of the EROI of oil production in California between 1955 and 2005. The EROI of this oil at the mine-mouth is shown in Figure 11. An exponentially decreasing curve is shown for comparison. The initial decline is greater than exponential.

Figure 11. EROI at the mine-mouth for California oil production between 1955 and 2005 plotted as a function of cumulative production.

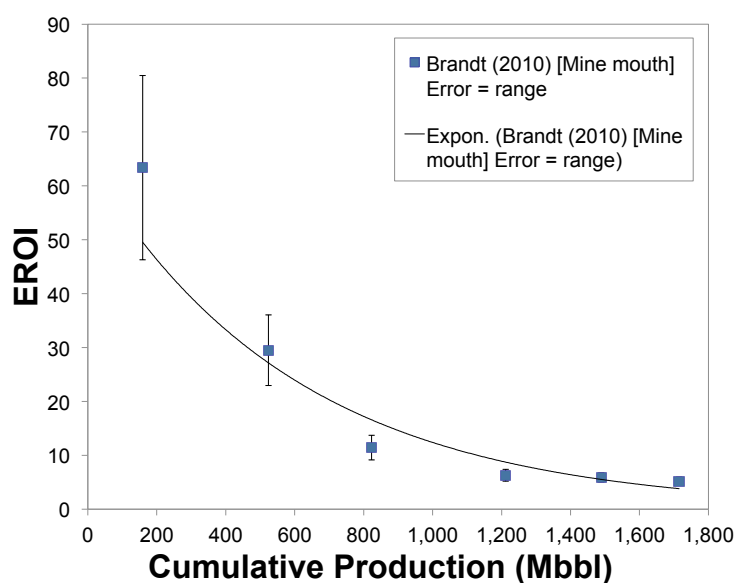

3.2. What Use is the EROI Function?

Presently, long-term energy forecasting is done by predicting (or perhaps, more accurately, stipulating) long-term production costs for various energy supply and conversion technologies. This information is then used to optimize a “least-cost” energy system that meets the projected future energy demand. The problems associated with predicting something as volatile as production costs over timescales of decades is rarely discussed. The issue of declining net energy yields is never considered.

EROI defines the relationship between the amount of energy that must be embodied as human-made-capital (HMC) in order to produce energy and the amount of energy that HMC can produce. In Section 1.1.1., the EROI was defined as:

$$EROI = \frac{P}{S_1 + S_2} \quad (10)$$

If the *capital factor*, κ , is now defined as:

$$\kappa = \frac{S_2}{S_1 + S_2} \leq 1 \quad (11)$$

Then, assuming that the annual production, \dot{p} is constant over the lifetime, L of the HMC, using Equations (10) and (11), the annual production can now be determined in terms of the HMC

$$\dot{p}[J/yr] = \frac{HMC}{\kappa} \frac{EROI}{L} \quad (12)$$

Although energy dynamics are not well understood, since EROI is a physical property of an energy source, it should be easier to predict over long time periods than energy production costs (in monetary terms) or prices. The EROI function may then enable long-term energy forecasts to be made which are more accurate than those using solely price-based dynamics. Such a projection, based on the principles of energy analysis, will also automatically obey fundamental physical laws, such as the first and second laws of thermodynamics.

4. Conclusions

We have presented a top-down framework for determining the EROI of an energy source over the entire production cycle of an energy resource. This function allows production costs (in energetic terms) to be predicted into the future. This EROI function, coupled with a purely physical allocation function to allocate energy demand between different energy sources, will allow a new form of energy supply forecasting to be undertaken, based solely on physical principles.

Acknowledgements

This work would not have been possible without the support of the Department of Mechanical Engineering at the University of Canterbury and the Keith Laugesen Trust.

References

1. Clerk-Maxwell, J. *The Times, London, 31 August 1950*.
2. Boustead, I.; Hancock, G.F. *Handbook of Industrial Energy Analysis*; Ellis Horwood: New York, NY, USA, 1979.
3. Peet, J. *Energy and the Ecological Economics of Sustainability*; Island Press: Washington, DC, USA, 1992.
4. Hall, C.A.; Cleveland, C.J.; Kaufman, R. *Energy and Resource Quality: The Ecology of the Economic Process*; John Wiley & Sons: Hoboken, NJ, USA, 1986.
5. Cleveland, C.J. Net energy from the extraction of oil and gas in the United States. *Energy* **2005**, *30*, 769–782.
6. Messner, S.; Strubegger, M. *User's Guide for MESSAGE III*. Technical report. IIASA: Laxenburg, Austria, 1995.
7. Seebregts, A.J.; Goldstein, G.A.; Smekens, K. *Energy/Environmental Modeling with the MARKAL Family of Models*. Technical report. International Conference on Operations Research: Duisburg, Germany, 2001.
8. OECD/IEA. World Energy Model—Methodology and Assumptions. Technical report. International Energy Agency: Paris, France, 2009.
9. Baines, J.T.; Peet, J. *The Dynamics of Energy Consumption : Changing Expectations for the Supply of Goods and Services*; Department of Chemical Engineering: Christchurch, New Zealand, 1983.
10. Brandt, A.R. The Effects of Oil Depletion on the Energy Efficiency of Oil Production: Bottom-up Estimates from the California Oil Industry. *Sustainability*, **2011**, *3*, 1833–1854.
11. Cleveland, C.J. An exploration of alternative measures of natural resource scarcity: The case of petroleum resources in the United States. *Ecol. Econ.* **1993**, *7*, 123–157.
12. Hall, C.A.S.; Powers, R.; Schoenberg, W. Peak Oil, EROI, Investments and the economy in an uncertain future. In *Biofuels, Solar and Wind as Renewable Energy Systems : Benefits and Risks*; Pimentel, D., Ed.; Springer: Dordrecht, The Netherlands, 2008; 109–132.
13. Cleveland, C.J.; Costanza, R.; Hall, C.A.S.; Kaufmann, R. Energy and the US economy: A biophysical perspective. *Science* **1984**, *225*, 890–897.
14. Leach, G. *Energy and Food Production*; IPC Science and Technology Press: Surrey, UK, 1976.
15. Cleveland, C.J.; Kaufmann, R.K.; Stern, D.I. Aggregation and the role of energy in the economy. *Ecol. Econ.* **2000**, *32*, 301–317.
16. Chapman, P.F.; Leach, G.; Slesser, M. Energy budgets. 2. Energy cost of fuels. *Energy Policy* **1974**, *2*, 231–243.
17. Costanza, R.; Cleveland, C.J. *Ultimate Recoverable Hydrocarbons in Louisiana : A Net Energy Approach*; Louisiana State University: Baton Rouge, LA, USA, 1983.
18. Hubbert, M.K. Nuclear Energy and the Fossil Fuels. In *Drilling and Production Practice*; American Petroleum Institute, Shell Development Co.: Presented before the Spring Meeting of the Southern District Division of Production, American Petroleum Institute, Plaza Hotel, San Antonio, Texas, March 7–9, 1956.

19. IEA. *Experience Curves for Energy Technology Policy*. Technical report. OECD/IEA: Paris, France, 2000.
20. Costanza, R.; Cleveland, C.J. Value Theory and Energy. In *Encyclopedia of Energy*; Elsevier: New York, NY, USA, 2004; pp. 337–346.
21. Liu, Z.; Koerwer, J.; Nemoto, J.; Imura, H. Physical energy cost serves as the “invisible hand” governing economic valuation: Direct evidence from biogeochemical data and the US metal market. *Ecol. Econ.* **2008**, *67*, 104–108.
22. Cook, E. Limits to exploitation of nonrenewable resources. *Science* **1976**, *191*, 677–682.
23. Rauh, A.; Seelert, W. The Betz optimum efficiency for windmills. *Appl. Energy* **1984**, *17*, 15–23.
24. Junginger, M.; Faaij, A.; Turkenburg, W.C. Global experience curves for wind farms. *Energy Policy* **2005**, *33*, 133–150.
25. NREL. Western Wind Dataset, <http://www.nrel.gov/wind/integrationdatasets/western/data.html> (accessed 10 February 2010).
26. NREL. National Solar Radiation Database, <http://rredc.nrel.gov/solar> (accessed on 10 February 2010).

© 2011 by the authors; licensee MDPI, Basel, Switzerland. This article is an open access article distributed under the terms and conditions of the Creative Commons Attribution license (<http://creativecommons.org/licenses/by/3.0/>).

Article

System Energy Assessment (SEA), Defining a Standard Measure of EROI for Energy Businesses as Whole Systems

Philip F. Henshaw ^{1,*}, Carey King ² and Jay Zarnikau ³

¹ HDS Systems Design Science, Synapse9.com, New York, NY 10040, USA

² Center for International Energy and Environmental Policy, University of Texas, Austin, TX 78713, USA; E-Mail: careyking@mail.utexas.edu

³ LBJ School of Public Affairs & College of Natural Sciences, University of Texas, Austin, TX 78713, USA; E-Mail: jayz@mail.utexas.edu

* Author to whom correspondence should be addressed; E-Mail: eco@synapse9.com; Tel.: +1- 212.795-4844

Received: 10 January 2010; in revised form: 12 October 2010 / Accepted: 12 November 2010 /

Published: 17 October 2011

Abstract: A more objective method for measuring the energy needs of businesses, System Energy Assessment (SEA), measures the combined impacts of material supply chains and service supply chains, to assess businesses as whole self-managing net-energy systems. The method is demonstrated using a model Wind Farm, and defines a physical measure of their energy productivity for society (EROI-S), a ratio of total energy delivered to total energy expended. Energy use records for technology and proxy measures for clearly understood but not individually recorded energy uses for services are combined for a whole system estimate of consumption required for production. Current methods count only energy needs for technology. Business services outsource their own energy needs to operate, leaving no traceable record. That uncounted business energy demand is often 80% of the total, an amount of “dark energy” hidden from view, discovered by finding the average energy estimated needs for businesses far below the world average energy consumed per dollar of GDP. Presently for lack of information the energy needs of business services are counted to be “0”. Our default assumption is to treat them as “average”. The result is a hard measure of total business demand for energy services, a “Scope 4” energy use or GHG impact assessment. Counting recorded energy uses and discounting unrecorded ones misrepresents labor intensive work as highly energy efficient. The result confirms a similar finding by Hall *et al.* in 1981 [1]. We use exhaustive search

for what a business needs to operate as a whole, tracing internal business relationships rather than energy data, to locate its natural physical boundary as a working unit, and so define a business as a physical rather than statistical subject of scientific study. See also online resource materials and notes [2].

Keywords: physical measurement; EROI; natural systems; net energy; energy economics; outsourcing; system boundaries; life cycle assessment

1. Introduction

1.1. Overview

One of the more difficult problems encountered in measuring the energy consumed in producing energy (EROI) [1,3] is deciding what contributing energy costs to count. It has been a long discussed question whether to include the energy costs of supporting employees along with the fuel uses for various production technologies, as some other ecological economists have also explored [1,3-5]. Historically economists have treated technology and business services including labor as independent parts of the economy, calling one “production” and the other “consumption”, to define statistical categories for physical accounting of businesses, overlooking their functional connections. The energy demand on the environment became “production costs”, counted as the energy receipts traceable to the supply chain for technology used in the business workplace. Other outsourced energy use needs, paid for from business revenues to operate but treated as in other categories, go uncounted. That assumption is presently used for Life Cycle Assessment (LCA) [6] following the world ISO 14000 standards for measuring business energy use, corresponding to green house gas (GHG) “Scope 3” protocol accounting contributions for measuring environmental impacts of business products.

We illustrated our approach using the model business plan for a Texas wind farm from our first study [7]. We assess both the traceable and the untraceable energy needs, based on whether they are required for the business to operate, and compare the totals. We find that counting only the traceable energy uses implies wind energy would be produced with an EROI of 31:1 producing energy at a rather low breakeven Levelized Cost of Electricity (LCOE) of \$0.002/kWh, using only ~20% of the average energy to produce \$1 of value. When counting the total energy demand the, EROI declines to 6:1, there is a 500% increase in the total energy accounted for, LCOE increases to a more realistic \$0.075–0.085/kWh and a \$ of revenue is produced at a more realistic 105% of the world average energy cost.

The method used, “system energy assessment” (SEA), is a physical measure of the total purchased energy demand (PED) for a business, and “Scope 4” energy assessment for total GHG impacts. The important departure we make is using a more objective and comprehensive method of deciding what energy uses to count, tracing physical causation rather than using statistical categories of energy use. It forces us to view both the consumption requirements for machines and for retaining qualified people and other services to operate machines to make businesses work, as equal energy demands on the environment. We count the energy uses of technology in the usual way, relying on the trail of purchase

receipts as traceable records. Estimates for the energy demands of the equally essential self-managing services employed are based on the predictable energy needs for the cost of their economic services.

Using SEA, the total purchased energy demand of businesses as whole physical net-energy systems becomes physical measure, called system energy E_S or product energy demand (PED). Then the energy return on business operations E_R is produced with an energy efficiency to society of E_R/E_S , to be also called $EROI_S$ for “societal” or “system” energy return on energy invested. We dispense with these suffixes when the intent is clear in context. What makes E_S a physical measure is the exhaustive search for energy needs for the whole working system it measures, defining the physical system with its energy needs boundary. Values of $EROI_S$ as the total energy costs of energy for different businesses, technologies and societies are, are then comparable like any other well defined physical measure such as heat or weight. Measures of $EROI_T$ (for production technology alone) omit the large amounts of untraceable “dark energy” outsourced for business services, resulting in an inaccurate measure only comparable for similar technologies in isolation from the businesses and societies using them. $EROI_T$ for labor intensive energy production, for example, would appear high compared to energy obtained with sophisticated technology, just because the energy costs for labor are not counted.

1.2. Scientific Methods

The SEA method arose as a special application of a more general “total environmental assessment” method (TEA) [8] designed to identify and anticipate change in the organized complexity of natural systems that operate as self-organizing units. Such systems generally include both passive parts and active processes, that develop and subside as they use their environments. That makes TEA and SEA studies of self-organizing systems rather than of deterministic ones, using an empirical rather than abstract modeling approach. As life cycle assessment, TEA focuses on the normally expected succession of changes in direction in the development of complex energy using systems, from inception through growth, responding to limits and eventual decline. SEA reduces that to measuring economic energy use for businesses as whole systems over a period of time.

Everyone recognizes businesses as having matched active and passive parts organized to work together as a unit. It has not been possible for customary scientific methods to define, measure or refer to them as physical subjects. SEA extends the scientific method to uniquely identify them as units of organization in the environment, using an empirical method arising from complex systems theories [9]. It identifies such systems in their own natural form by identifying them with a reproducible way to define a form fitting boundary and quantitative measures. That expansion of the scientific method for defining complex systems and their measures allows the sciences to treat complex systems as physical subjects, connecting money and energy, so physics can fully apply to economics and the systems sciences such as economics and ecology can broaden the questions of physics.

The procedure for fitting the accounting boundary to the system starts from any part of the business, and tracing physical causations locates everything else the business needs to operate as a whole. We just repeatedly ask: “What else is needed to make it work?” for the business as a self-managing entity to operate in its environment. That provides an objective method for locating the boundary for the working parts as a discovered feature of the business, to the degree of fit that is practical. Adding up all the energy costs for parts within that empirically located boundary results in a quantitative scientific

energy measure, and identifies it as a bounded network of working parts. The features of its internal and external relationships can then be studied, as physical subjects with energy budgets of their own, despite having complex parts and features not definable from the information used to locate its boundaries. More discussion of complex systems theory is not needed to use the SEA method.

How one studies a physical system that is more complex than the information that identifies it is like how a tree leaf is revealed by a simple “leaf print” or a broken bone is revealed by an “x-ray”. The one kind of information is used to project features of a complex natural system. It reveals useful missing information about it that may be further explored, generally raising good questions by exposing the natural forms for study. That step is what makes this way of accounting for businesses as whole systems a bridge to studying them as a physical science rather than just a statistical science.

Unifying the questions of the sciences around complex systems as objects of the environment allows them to be studied from those multiple perspectives. Science has previously needed to discuss complex systems only in relation to each field’s own abstract models. Models of the same complex subject from different views might be different, but at least they would be understood to be connected by referring to the same thing, and not unrelated by being different. Some brief discussion of how to use SEA and EROIs measures for connecting policy, business, ecological, economic, environmental design, thermodynamic and other scientific views of energy systems is included in the discussion.

The main innovation of the method is a way to use physical causation to locate energy requirements that business information does not record. What is missing from models when describing physical systems comes naturally, in the form of unanswered questions about energy processes, that statistical models don’t raise, because of the conservation of energy and other explanatory principles of physics for tracing causal connections. Causal models allow energy uses to be found from their physical processes and natural histories, even when recorded data is not available. For example, the physical energy link between the services of people and the technology they operate can be identified from the tiny amounts of physical energy they exert to operate technology, obtained from their food purchases. It is that energy applied to the buttons and levers of machines using the “know how” and “control” provided by people that operate the business and allow both the machines and people to do their jobs.

From the business manager’s view that minute fraction of the food energy that employees consume at home to operate machines at work is vanishingly small. It is still paid for from business revenues and is the essential service provided by employees. It is vanishingly small and insignificant only in quantity, compared to the energy consumed by the machines being controlled. From a physical system view the energy consumed in the environment for the business to obtain those tiny amounts of control energy are its largest energy cost of all. That energy to do its work comes only with employees having the choice of how to spend the rest of their earnings, what they do the work to have. It is part of their pay package, agreed to in exchange for their exerting their minute amounts of smart energy to operate the business. They wouldn’t come to work and provide their service without it. Their minute amounts of applied energy, delivering “know how” to make things work, are the highest quality energy source in the world, it seems, and it costs large amounts of energy consumed elsewhere to generate it.

In assessing these hidden energy needs we use a “null hypothesis”, that it will be more accurate to initially estimate any cost of business as representing an average energy use per dollar than a zero energy use, as if not counted. The error one way is sure to be infinite and the error the other way is likely to be equally positive and negative for a reasonable sample size. We then look for the available

information to refine that initial estimate. Why the energy uses needed to deliver any purchase are likely to be average is also due to how widely and competitively energy is used. Energy is a costly necessary resource at every step of delivering any product or service, has a world price, can substitute for most any other resource and product markets seem to reallocate it to wherever it is most valuable. As the energy needs of business are largely in the services of diverse people and businesses with similarly diverse habits, the energy content of most products is logically going to be closer to average, on average, than greatly above or below. Further study, of course, is clearly needed as well.

1.3. Background of Measuring Business Energy Use

The common method of measuring the energy used by businesses is based on the ISO 14000 world environmental management standards for assessing the energy consumed by production technology using life cycle assessment (LCA) [10]. LCA collects business information about resource uses for production technologies over their useful life, including their supply chains and eventual disposal, using well defined analytical boundaries to measure their total resource needs and impacts [6,11]. What is not included are the resource needs for which there are no directly traceable records, such as for having employees and using other business services that determine their own resource consumption choices, and leave no detailed records for the business employing them. Consequently the available data sources do not identify that consumption as associated with the business employing the services that generate it.

The available energy use data is generally recorded and collected according where the energy uses occur, instead of according to what productive activities they serve. As a result it becomes named for economic sectors or types of technology producing the records, rather than the businesses employing the services causing it. Considerable statistical study has been done based on the recorded energy use accounts to identify benefits of technology, links between economic sectors [4,9,12-14] and their relation to growth [3,4,12,15-18]. The data is mostly aggregated by various government agencies, such as the Bureau of Economic Accounting and Census Bureau [1,19] for the US. The energy uses for steel manufacture are associated with the steel industry, for example, and collected in Input-Output tables by industry group. The energy for the steel going into cars, buses and trains used for business commuters will never show up as an energy cost of hiring employees, though.

What the available data has been most useful for, and LCA is an extension of, is accounting for the performance of individual technologies to optimize energy consumption for production processes. It later became relied on for measuring environmental impacts. LCA starts with adding up directly recorded resource uses and then adds traceable uses in the supply chain trees of contributing production technology. Limits to those trees are set using proxy measures for the tails of supply chain distributions that become uneconomic to individually trace. That serves to effectively “disaggregate” some of the I-O data from national energy use accounts, and assign parts to the service of individual business processes. The first effort to use hybrid accounting to trace and disaggregate “indirect” energy use associated with business products seems to have been by Bullard [20], to then be refined by Treloar [11] and others, leading to the current LCA method standards [6].

As under ISO rules for LCA, those methods counted only the energy costs a business pays for required by “production technology” and not for “production services”, considering them as

“consumption costs” instead, as follows from naming accounting categories by where the data was recorded. There has been considerable discussion of this over the years, with the economists continuing to separate resource “consumption” costs from “production” costs, whether both controlled (equipment) and uncontrolled (people) equally require consumption to do their productive work. Government statistical categories and models also separate the energy use into categories by where it is used, and treat energy for technology as production and for self-controlled parts of businesses as consumption, as if separate systems.

Even leading systems ecologists such as H.T. Odum [21] analyze and model economic energy uses in the environment by separating the energy consumed by technology labeled “production” and the energy uses needed for employing people and other business services labeled as “consumption”. A few others including Costanza and Herendeen (1984) [12,5] have counted some part of both as environmental costs of business. The study of EROI for US coal, petroleum and nuclear energy reserves by Hall, *et al.* [1] is an exception, in both comparing different scales of inclusiveness for assigning energy uses throughout the economy for delivering energy to society, and showing estimates of the energy costs for employing all necessary economic services to result in a scale change of ~500% in the energy accounted for. His EROI3 scale of inclusion also roughly corresponds to our SEA3 scale of inclusion. As to which expenses to consider, we initially assume that any cost a business incurs is probably intended to be in the service of the business. We then assign it a unit energy cost, as further discussed in Section 2.1., and seek to verify it.

The usual sticking point in the discussion with economists and others practiced in LCA is the idea that if an employee loses their job they will continue many of the kinds of spending they had when employed. That is, however, argued as a reason to not count the spending of the employed worker as an environmental impact of being employed as well as that of the unemployed worker. We think that argument overlooks both how unemployment spending comes from the savings or government services paid by employed workers, as well as the many large environmental costs of supporting all the other kinds of business services which have individually untraceable resource requirements.

1.4. Economic Sector Intensities and the SEA Method

Figure 1 shows the data from the adjusted I-O table by Costanza [12] arranged to show the relative energy intensities for all US economic sectors in 1963, arranged by the scale of each sector’s total energy use. The specific data is quite old in one sense, but the general distribution of intensities and scales is probably similar today. The value of the figure is showing the diversity of technology energy uses compared to income for small sectors, and large sectors all close to average.

If these values were adjusted to distribute the energy costs of employees and other business services to the businesses employing them, the intensities per dollar of output would increase for all producer sectors, with the steel mill including the energy costs of employing steel workers, *etc.* Their variation would decrease, though, as all came closer to average. That would redistribute the costs of the consumer sectors to producer sectors to account for 100% of energy use for production. A separate table for energy use would be needed to show energy costs by sectors for end consumption.

Until that redistribution is done, using energy intensities by economic sector, as from I-O tables like Costanza’s would be misleading as estimates of energy use for whole business costs. Line items in

business budgets don't usually correspond to any one business sector, and also not to an average group of business products from any particular sector, which is what I-O tables show. Economic sectors are vast aggregations of different kinds of businesses offering highly varied kinds of products. Business budgets call for particular products or services. Even when an item seems to correspond to an industry group that has only one product, say steel beams, or fuel oil, only the recorded technology energy uses for that sector are included. So for any particular product from any sector, the sector data does not show most of the resource uses those businesses pay for being used. All but the production technology costs are scattered over other sectors.

Figure 1. Energy intensity of US Economic sectors for 1963; sector btu/\$ revenue as % of total btu/\$ GDP (vert. axis), by sector size as share of US economy (horiz.axis). Largest sectors have near average intensity. Energy sectors have low intensity for the revenue earned. High intensity sectors mostly small and varied [12].

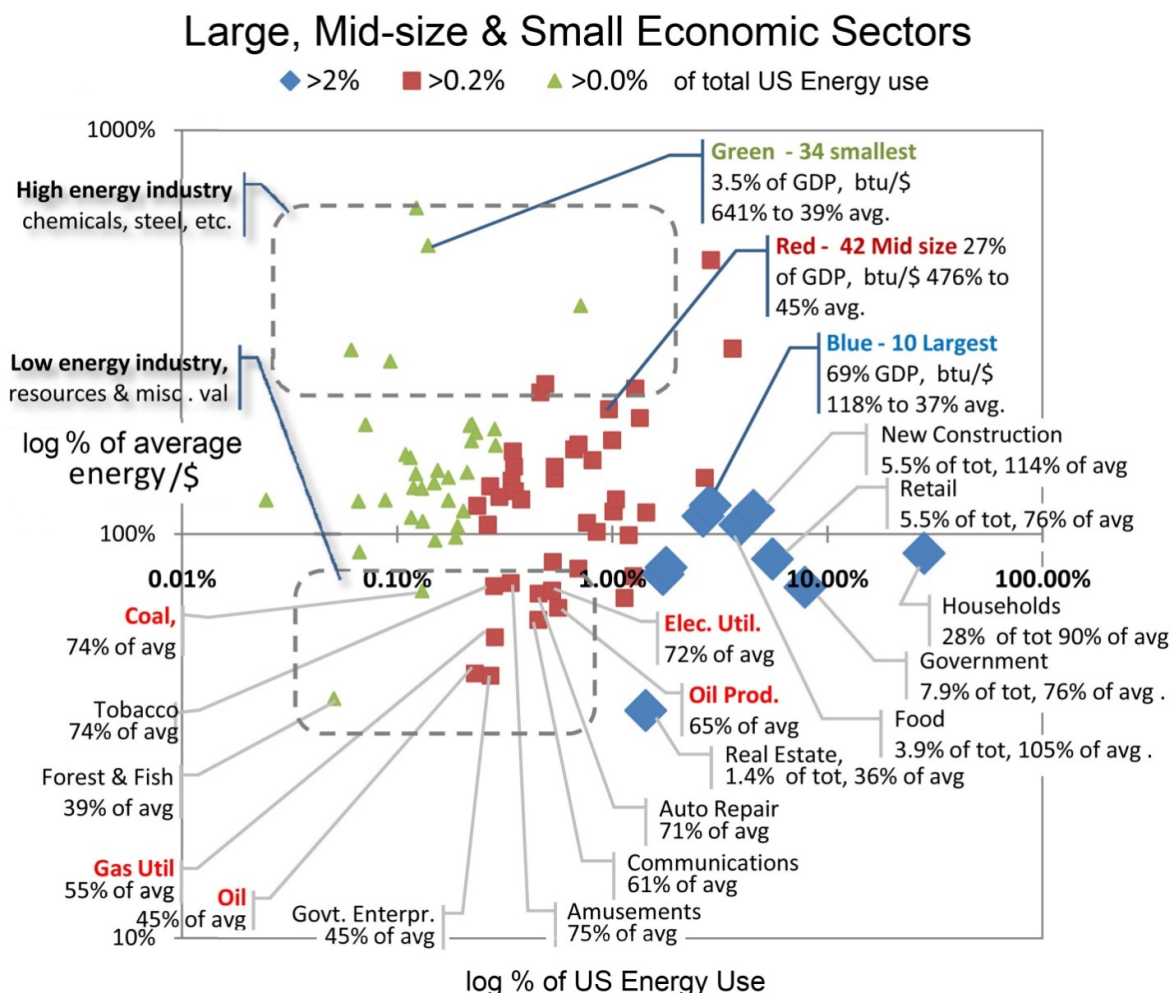

If I-O tables were redone to distribute consumption costs to the businesses paying for them, patterns likely to persist are (1) high intensity sectors would still have the most varied energy intensity, (2) the largest sectors would be close to, but below average and (3) the energy producing sectors would have somewhat below average energy intensities. The energy sectors do consume lots of energy, but it also has a high value added, and so the ratio of the energy used to the value produced is low.

Another problem for applying I-O table data to estimating particular energy needs is how the data reflects only national energy accounts. Most products and services have substantial global content. For example, a great deal of the high energy using production for products consumed in the US is now performed overseas, particularly in Asia. EIA data shows energy use in the US beginning to level off starting in the 1970's, even as US GDP and consumption continued to grow [22] (see Figures 3,4). That rapid divergence between US energy use and GDP is the complete opposite of the consistent world GDP and energy use relationship over the same period. The global trend has been of smoothly growing GDP and GDP/btu [22] (see Figure 1) in constant proportion. Explaining why the global data shows such smooth global trends, and national accounts do not, has been argued as a statistical fluke or the averaging of random variation. Our expectation is that it is a result of the global economy working smoothly, to allocate resources according to the comparative advantage of productive differences for individual business communities around the world, as free market theory has always suggested it should.

1.5. Background on EROI for Wind Turbines

Kubiszewski *et al.* [14] performed a meta-analysis to summarize the net energy of wind turbines based upon a suite of previous studies of 114 calculated values for EROI (see Figure 2). The wide spread of the data shows evidence of large inconsistencies in the methods of defining which energy inputs to count. The variation is over an order of magnitude with reported values from over 50:1 to near 1:1. The average EROI for all studies was reported at 25:1 although the average for operational LCAs (those based upon actual performance of a turbine) was lower at 20:1. There is as yet no national account data for a wind energy sector industry group to compare. Wind utilization estimates varying from 15% to 50% also add to the inconsistency in assumptions presented.

Kubiszewski *et al.* described process analysis methods, including LCA, and compared them with studies using I-O table data. The former showed an average EROI of 24:1 while the latter had an average EROI of 12:1, a difference some attributed to how process analysis involve a greater degree of subjective decisions [14]. The differences in capacity factors and from omitting the untraceable energy needs of labor and business services required [23,24] would seem to account for the variation. These results are comparable to the method presented here only as studies of business-scale energy use for which there are no industry group studies.

Figure 2. The distribution of estimated EROI values from a survey of past wind energy studies [14], showing the number of findings in each EROI estimate range. The unusually wide variation in estimates implies the use of inconsistent standards.

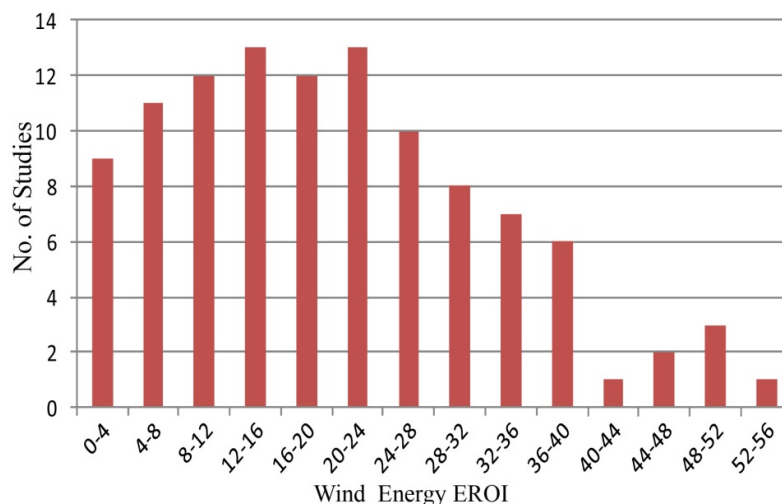

2. Methods

The SEA method allows us to disaggregate global energy use data for individual business costs. It uses “hybrid” accounting to combine recorded and proxy measures of energy use based on average intensities for monetary costs, not dissimilar to Bullard or Treloar [11,20]. Instead of using intensities for only technology energy uses, our intensities are for shares of global economic energy use, adjusted in relation to that average if good reason is found.

The key step, from a physical science view, is our method of deciding what energy uses to count. To identify what energy uses are necessary for the operation of a complex environmental system, such as a business, one needs to develop an exhaustive search strategy as a means of deciding what to include. In practical terms that means defining a starting point a then a way to expand the search and then determine when you are at a stopping point. The starting point we use for our case study is an LCA estimate for the life cycle energy costs of the wind turbines and their related capital costs for plant and equipment, for our conceptual model of a Texas wind farm, based on JEDI and VESTAS project data [25,26]. We could start from any other part of the business too. We just chose to use the usual ending point of business energy assessment as our starting point.

Our procedure is then to ask what else is needed to make those parts of the business work, over and over, until we have exhausted what is needed to deliver the product to market. In that way we let the business as a working system, in its natural form, guide the questioning and determine the limits. That end point identifies the whole working organization of the business as an operating system. A business is a system that makes internal choices for how to work as a whole, operating in a larger open market economy. The economy may determine what its options are, but leaves it a considerable range of choices. As an financial system the line where the internal organization of the business comes to an end, and the external parts and market organization of the economic environment begin, is determined by whether decisions made affecting the business are being paid for from business revenues. Those

decisions paid for by the business define the business as a system of complex design organized by the choices of its decision making parts for operating in the environment they face.

A business decides how much to pay workers, depending in part on what kinds of employee skills and self-reliance it needs and what pay package would attract them. A business will generally not determine what city services it gets or pay for them as operating costs, though they will be paid for as essential environmental costs of operation through paying taxes. A business does not pay for the train siding a mile from their plant except in user fees, as that is a service for sale by another business. A business might choose to pay for a community golf outing for its executives to socialize with local business leaders, or support popular political parties, considered as costs of good community relations. A business wouldn't pay for related businesses springing up around it, allowing them to diversify or specialize in higher value added products perhaps, as those are market mechanisms involving decisions by others, though having good community relations might help local industry development of that kind. In one society or another, or for family operated *versus* publically owned businesses, business decisions may be made very differently. So other criteria may sometimes be needed to distinguish the internal organization of the business from the external organization of its environment. The special task of analysis, that causal models allow and information models don't, is estimating one's lack of information about untraceable energy uses. The search method sends you looking for missing information. This is actually the great benefit of using a physical systems model. An information model would not tell you what information is missing. Using our approach following the working parts of the business by their physical connections then lets us assign energy costs to their dollar value. That is done initially by using the well established consistent relationship between the measures of global purchased energy use and GDP as a basis for equating shares of one with equal shares of the other. That is how we calibrate our "proxy measure", by attributing shares of global energy use in proportion to shares of global economic product. This is where the null hypothesis applies, that average will be more accurate than zero, and the following question is whether other information is available to assign a particular intensity above or below average.

Businesses do not generally pay for things they don't need, so the functional boundary of a business's energy uses would generally match what a business pays for. We did not arrive at that conclusion backwards, by just making an arbitrary choice to start using a different formula for energy estimates. We found that the choices paid for coincided closely with what a business physically needs to independently operate in its environment, by going step by step in accounting for necessary energy uses for which there was no other record. It's the exhaustive search for the parts that need to work together, seeing what organizational unit they are part of and assessing their energy needs, that makes the link of physical causation as good as having a receipt for the energy use.

Our demonstration procedure detailed in Sections 2.1.–2.4. below, is to identify working units of the business (SEA_N) to assess and combine. For each we use a table necessary operations, for carefully combining the "technology energy use" (T_E), recorded in energy units, with estimated "economic energy use" (E_E) recorded in money units following a business plan, so GED is $\Sigma SEA_N = T_E + E_E$ (adjusted for overlap), assessing predictable energy needs over the lifetime of the investment. We assign economic and technology intensity factors, T_{ii} and E_{ii} in relation to the world average energy intensity E_{iW} , for translating energy to money or money to energy, using whatever method seems best on a case by case basis. As part of a whole system approach we complete the search with questions

about missing information that might remain unaccounted for. We define EROI in the normal way, though by including all energy demands to the point of sale and release of the product for use by others, has new meaning.

What becomes most clear is that understanding the true scale of energy needs of business is well worth the added uncertainty of combining precise data with imprecise econometric measures. It demonstrates that easy and imprecise measures are far more accurate than time consuming precise measures when the latter are a small fraction of the total. As part of a whole system assessment method, the further task is to consider how a better understanding of the business as a system helps you understand its wider roles in the economic and natural environment, that affect business and public values and decisions. We use that discussion for pointing to a sampling of other directions of study.

2.1. Measurement Strategies for System Energy Assessment

We use hybrid accounting to combine precise measures of energy use that are very incomplete with rough statistical measures that are very comprehensive (Figure 3). When combining direct records of energy use with statistically estimated energy uses the statistical estimate may need to be reduced to having duplicate recorded and estimated amounts for the recorded energy use (Figure 5). We also develop a strategy for the problem that every fuel use also costs money, and so has both embodied energy content in the economic services that delivered the fuel, in addition to the physical energy bound in the fuel itself. The money paid for fuels is paid to other people for the rights to it, and not for the fuel itself. The fuels themselves come from nature, for “free” and are never paid for except in the energy cost of extraction.

Figure 3. Estimating whole system energy use (outer circle) with overlapping direct measures (islands) and proxy measures (inner circle). Direct records of technology energy use (T_E) need to be combined with estimated economic energy use (E_E) at the world average intensity ($\$E \cdot E_{iW}$), and be corrected for overlap.

Finding boundaries starting from accountable parts

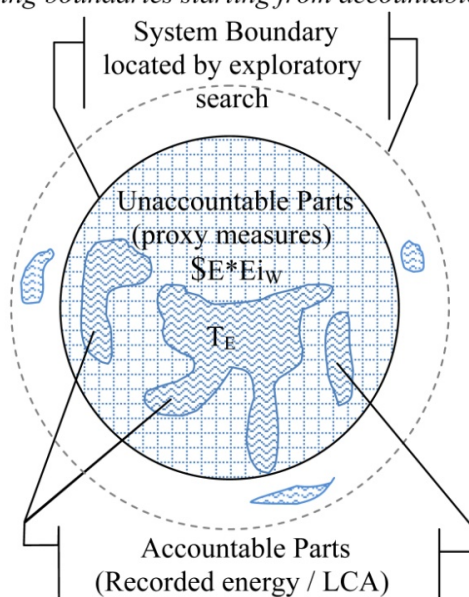

How we proceed with presenting the method is a little more involved than one would need to use in practice. For demonstration we identify six organizational scales, and go step by step asking what else each needs to operate, assessing and combining energy values for traceable technology (T_E) and individually untraceable economic services (E_E). We start from the LCA estimate for the energy needs of the principle capital investment technology for the wind farm as the first value of T_E that we call LCA_E , and consider the smallest whole working unit needed for the wind farm. The technologies of the supply chain businesses are passive equipment that can't operate by itself, though, without the employees and the other business services to operate those businesses. When we add energy use estimates for the active self-managing parts a combination of parts that could operate by itself results, the supply chain, that we call SEA0. Then we ask the same question again.

What we first find is that the principal technology of a wind farm needs a field operation to control and maintain it, and so we add to the accumulating total the needs for those operations and services calling it SEA1. We then do the same to add the operation costs of the wind farm's business office to make SEA2 and the costs of its corporate management to make SEA3. That completes the set of internal units of organization and business costs to account for. We then assess the energy needs that a business will pay for to maintain the external business environment, that we call SEA4, paying for financing costs and taxes to be used by government (Figure 4).

Figure 4. System Energy Assessment (SEA) combines technology energy use (T_{E1} to T_{E4}) with energy use for economic services (E_{E1} to E_{E4}), searching for all the needed energy uses for all the scales of operating units of the whole working business system.

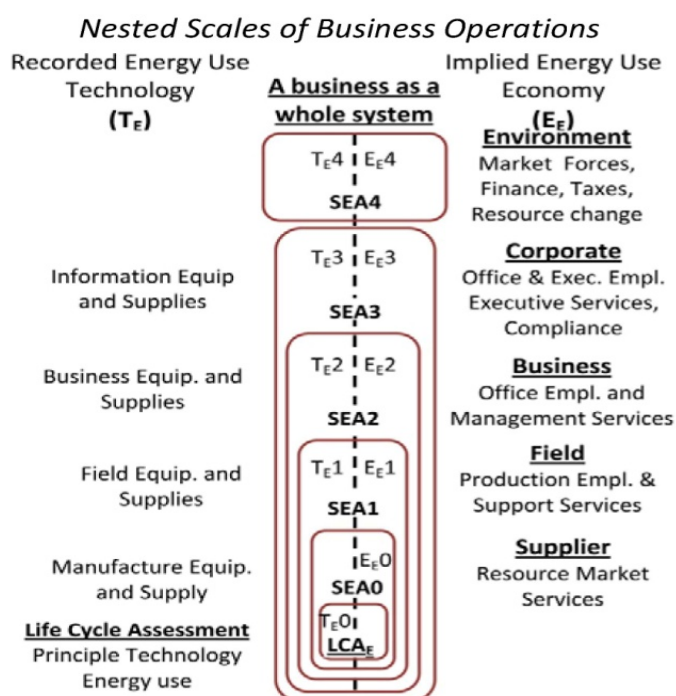

LCA_E : Energy use of technology supply chain measured by LCA; SEA0: adding the energy cost of supply chain economic services; SEA1: adding the energy needs for field operations; SEA2: adding energy needs for business management; SEA3: adding energy needs for corporate management; SEA4: adding energy needs for environmental services, the costs of society, taxes, finance.

This series of estimates treats the business as a nested hierarchy of larger scales of organization, with each larger scale serving as the environment for the smaller scale. We present it this way here to illustrate the learning process of asking the same question over and over to locate the boundary of the system as a whole. Each organizational level shown is a “whole business” or “profit center” on its own, then found to also be needing other things to bring its product to market. Economies contain many kinds of nested systems and it is helpful for interpreting results to learn to recognize and describe them. The end point of the search for the necessary parts of the business ends where the product is handed over to someone else. At that exchange the business is paid so it can continue to function. We call the EROI estimates at for SEA3 and SEA4, respectively, “internal” and “external” distinguishing two standard EROI’s, labeled $EROI_{Si}$ and $EROI_{Sx}$ if being compared. $EROI_{Si}$ measures of the physical performance of the business independent of the environment it is in. $EROI_{Sx}$ might be used to comparing different business environments for the same business model, and so treating economic development studies as physical systems ecology.

2.2. Double Counting Corrections

For each line item in the estimate we can also use either simple or complicated ways of combining values of T_E and E_E . For converting financial costs to energy estimates we assign a weight factor (T_{ii} for technology energy and E_{ii} for economic energy) for applying the world average economic energy intensity, E_{iW} to the individual cost item. If you were to add up all the purchased fuel uses in the world and combine that with the average fuel use for all end purchases, the total would be exactly twice the total energy use. To correct for that chance of “double counting” when combining T_E and E_E values, there are three options from simple to complex. Option 1 is to ignore the problem for rough estimates when the scale of unrecorded energy uses is evidently much larger than the recorded ones. Then the overlap of combining them will be small compared to the total, and might be within the margin of error for more careful estimates of the total in any event. Option 2 is to carefully choose values of T_E and E_E to not overlap, allowing them to be directly added. That is the case when estimates of T_E are for the total traceable energy needs, like a careful LCA estimate provides, and values of E_E estimate only the business’s untraceable energy costs. Then the two can then be added directly without overlap.

Option 3 is a way to begin with estimates of E_E as the combined traceable and untraceable energy uses, and adjust it for partial records of recorded energy use T_E , like including actual heating and electric bills while removing the implied average heating and electric bills in the estimate of the combined total. . To do that the value of E_E is reduced by the economic value of the recorded energy uses before being combining with T_E , removing that implied share of E_E to eliminate the overlap when then combining T_E with the adjusted E_E (Figure 5). This is also described in Equations 7 & 8. It is interesting and important to note that if lack of information requires assuming the business has average economic intensity, a weight factor $E_{ii} = 1$, the arithmetic for adjusting E_E to not overlap with T_E will cancel out, and so have no effect. That means that in the normal case, where you don’t have reason to assume an energy intensity other than average, *it has no effect to count any recorded energy use*. Only for costs you know for other reasons to have non-average intensity is correcting for overlapping estimates of T_E and E_E needed. Experience and the availability of published weighting factors will determine what you choose. These options can be selected line by line if desired, as part of assigning

weighting factors to reflect how much above or below the world average energy intensity (Ei_w) is to be allowed for. Table 3 below is organized for option 3 and used for option 2 where appropriate. Option 1, of course, saves a great deal of time for quick estimates.

Figure 5. To avoid double-counting $\$T$, the economic value of T_E at average intensity Ei_w , is taken from the item costs, $\$E$, before applying the scaling factor Eii for the proxy measure.

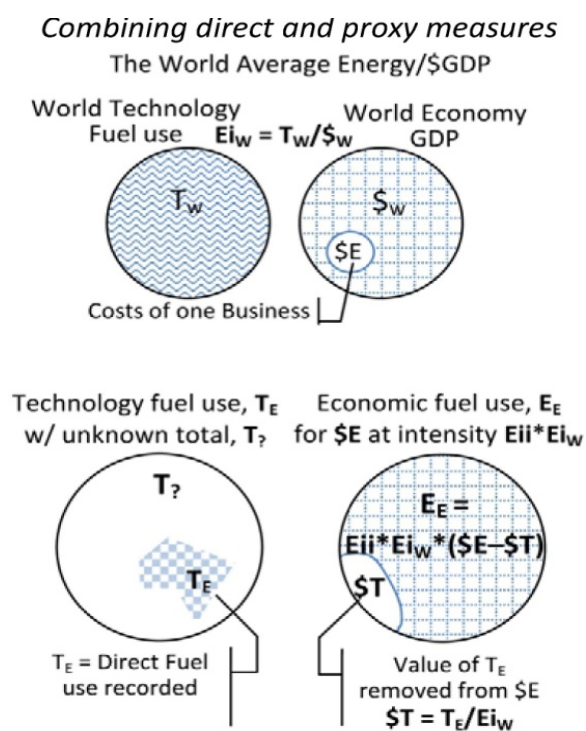

2.3. Calculations for System Energy Assessment

For world energy intensity (Ei_w) we use the EIA world marketed energy consumption and global domestic product corrected for purchasing power parity (WMEC/GDP-PPP). World GDP-PPP was \$59,939 billion (\$2005) with 472 quads of purchased energy [27] for an average intensity of 7,630 btu/\$ or 8050KJ/\$ in 2006. To standardize on electrical energy units we convert kWh:

$$Ei_w(2006) = \frac{472e15 \text{ Btu}}{59,939e9 \$2006} = \frac{7,630 \text{ Btu}/\$2006}{3,410 \text{ Btu}/\text{kWh}} = 2.24 \text{ kWh}/\$2006 \quad (1)$$

Average economic energy intensity varies widely between national accounts[28], but world energy intensity displays remarkably smooth change and proportionality to GDP. The variation between national accounts appears to reflect comparative advantages for specialization in products and services so we choose to use the global average as the default assumption. The world average shows a regular rate of decline of $\sim 1.3\%/yr$ using an exponential fit to the historic data, by Equation (2), where x is the number of years after 2006 [27,33, Appendix I]. For example, in 2020, at the midpoint of our 20 year project starting in 2010, the current value of Ei_w will have decayed to 1.87 kWh/\$2006. Differences in price and value (utility) for different kinds of fuels (e.g., oil, coal, electricity, etc. having different uses and prices per Btu) [3,16,19], were not used for shares of the global mix of purchased fuels.

$$Ei_w(x) = 2.24 * (1 - .013)^x \quad (\text{kWh}/\$ \text{ for } 2006 + X) \quad (2)$$

It is not necessary to account for the business as having nested scales of organization. We do it largely to help demonstrate the method. We aggregate the additional energy identified at each j^{th} working unit level as $dSEA_j$, as shown in Equation (3), where $T_{E,k}$ and $E_{E,k}$ are combined after adjustment to for overlap if needed, for “ M ” business costs assessed, and “ j ” is the level of organization considered. The total energy input (SEA_N) for the whole business system is the sum of the added energy inputs for each of the “ N ” business units (Equation 4).

$$dSEA_j = \sum_{k=0}^M [T_{E,k} + E_{E,k}] \quad (3)$$

$$SEA_N = LCA_E + \sum_{j=0}^N dSEA_j \quad (4)$$

Values of technology energy (T_E) may be obtained either from fuel use records or from fuel or technology costs or budgets ($\$T$) multiplied by the appropriate intensity weight factor T_{ii} and the average energy intensity of money (Ei_w), Equation 5. Values of economic energy use (E_E) are similarly calculated using economic costs ($\$E$) multiplied by the appropriate intensity weight factor (E_{ii}) and the average energy intensity of money (Ei_w), Equation 6. If those values represent partial measures for different things that may overlap the added step of removing an estimated economic value for T_E from $\$E$ is needed to eliminate the overlap between the definitions of the two measures (Figure 5), so $\$E$ is reduced by $\$T$ before T_E and E_E are combined (Equation 7, 8).

$$T_E = \text{recorded fuel use, or } T_E = \$T \cdot T_{ii} \cdot Ei_w \text{ in relation to cost} \quad (5)$$

$$E_E = \$E \cdot E_{ii} \cdot Ei_w \text{ in relation to cost} \quad (6)$$

$$\text{Or, with } \$T = T_E / (T_{ii} \cdot Ei_w) \quad (7)$$

$$E_E = E_{ii} \cdot Ei_w \cdot (\$E - \$T) \quad (8)$$

2.4. Models and Input Values

We present two separate models (1) using a table with 20 year average costs without discounting and (2) a cash flow model with discounted costs over time. Both models use the same 20 year business plan based on the JEDI budget for a 100MW wind farm [26] as if located in Texas. All money and energy costs are stated as per kW of total generating capacity. LCA data was obtained from the Vestas Onshore 2.0 MW wind turbine study [25], 13,100,000 MJ (3,640,000 kWh). The distribution of energy types for the LCA account is shown in Table 1, showing somewhat more fuel from oil than the world average. Table 2 displays the key business model inputs, including the wind generation capacity factor and other distributions from the DOE 2008 wind report [10]. Our equations for both partial and total EROI and LCOE measures follow the usual standard definitions as in Equations 9 and 10 respectively. A simple version of our Excel model with data and formulas is available [29].

$$EROI_n = E_{out} / E_{in} \text{ for each SEA level} \quad (9)$$

$$LCOE_n = \frac{NPV(\sum C_T + C_E)}{NPV(E_{out})} \propto \frac{\text{partial costs assessed}}{E_{out}} \quad (10)$$

Table 1. The quantity of fuel consumed for a Vestas 2.0 MW turbine has an energy content of $LCA_E = 13,100,000$ MJ [25] assumed to cost \$150,000.

Fuel/Resource	Energy Consumed		Fuel Cost
	(MJ)	(kWh equiv.)	(\$/GJ)
Hard coal	2,215,252	615,348	\$2.34
Crude oil	6,036,167	1,676,713	\$12.23
Lignite (brown coal)	445,079	123,633	\$1.90
Natural Gas	1,618,058	449,461	\$6.21
Nuclear Power	392,124	108,923	\$21.65
Straw	0	0	\$0.95
Wood	0	0	\$0.95
Other Biomass	57,917	16,088	\$0.95
Primary energy from Hydropower	2,286,239	635,067	\$21.65
Primary energy from wind	37,184	10,329	\$0.95
TOTAL Cost of fuels (\$) =			\$147,958
Btu/\$ of fuel purchase -			83,777
Btu/\$ for fuel purchase : economy average Btu/\$ (2010) -			11.5

Table 2. Some SEA input factors are estimated using probability distributions[30], while most inputs are kept constant at nominal values.

Input Variable	Units	Value
Capacity Factor*	%	$\mu 32.6, \sigma = 6.7$
Equipment Cost*	\$/kW	$\mu = 1,433, \sigma = 125$
Balance of Plant Cost*	\$/kW	$\mu = 483, \sigma = 42$
Annual Operation and Maintenance*	\$/MWh	Lower bound: 5, Peak = 10, Upper bound = 30
Loan Interest Rate	%	6.8
Land lease cost	\$/turbine	6,000
Loan amount	% of first costs	80
Time limit of loan	yrs	20
Economy inflation rate	%	3%
Marginal federal tax rate	% of annual profit	35%

* From DOE 2008 Annual Wind Technologies Market Report [27].

Section 3.1. presents the cash accounting model shown in Table 3, for 20 year average costs per kW of generating capacity. To represent a realistic consumer market and achieve an annual net revenue of 11% after taxes, we set a market price of \$83/MWh. The tax rate on net revenue at SEA4 is set at 36% to approximate the ratio of total US local, state and federal government costs to GDP. Table 3 shows combining the values of T_E and E_E using assigned values of T_{ii} and E_{ii} , based on each item's character and dollar cost by the SEA method. Starting with LCA_E we add estimates for the other scales of business operating units (SEA0, 1, 2, 3 & 4). Values of T_{ii} for technology items are based on the ratio of LCA_E /\$ of first costs, or as indicated. Values of E_{ii} of 1 are used except as indicated. Column 8 shows typical budgeting ranges estimates for the input costs in column 1. Section 3.2 presents results of a second similar model for comparing the cash and energy flows as they change over time. It shows world average intensity, E_{iW} , decaying at the recent normal rate of 1.3%/yr with a discount rate of 6%.

Table 3. Whole business SEA system energy Input/Output table, arranged by business unit scale.

Output per kW capacity at 32.7% factor		Value	\$/kWh	kWh	oper.	net	AvgCost	Wh/\$	Tax rate	
Electricity Sales		\$236	\$0.083	2,856	\$129.94	82.0%	0.0455			
Average for Economy								1,883 ²	36.2%	
		1	2	3	4	5	6	7	8	
		\$E	Tii	T _E	\$T	Eii	E _E	SEA	Est.	EROI
Inputs per kW installed capacity/yr		Cost	% Avg	kWh	Value	%Avg	kWh	kWh	Range	
LCA_E	Primary Technology & Equip.		13.1 ³	90.9	\$3.70			90.9	0.1 ⁵	31.42
dSEA0	annualized Tech & Equip. Cost	\$71.63		0.00	\$48.26	1.5 ⁴	66.03	66.0	0.15	
	annualized Phys Plant Cost	\$24.15		0.00	\$0.00	1.5	68.22	68.2	0.15	
Subtot& Range		95.78						134.2	0.30 ⁵	12.68
dSEA1	Field technology	\$18.12	0.5	17.2	\$9.13	1.5	25.4	42.6	0.2	
	Field fuels	\$0.27	12.1 ³	6.15	\$0.00	1.0	0.51	6.66	0.2	
	Field Business Services	\$0.20 ⁶	-			0.9	0.34	0.34	0.3	
	Field employees	\$2.75	-			0.9	4.66	4.66	0.3	
Subtot& Range		21.34						54.25	0.37	10.22
dSEA2	Business technology	\$0.25	0.5	0.24	\$0.13	1.5	0.35	0.59	0.3	
	Business Fuels	\$0.54	12.1	12.29	\$0.00	1.0	1.02	13.31	0.3	
	Operating Business services	\$1.50	-			0.9	2.54	2.54	0.3	
	Business salaries	\$1.54	-			0.9	2.61	2.61	0.3	
Subtot& Range		3.83						19.05	0.31	9.57
dSEA3	Corporate technology	\$0.10	0.5	0.09	\$0.05	1.5	0.14	0.24	0.5	
	Corporate Fuels	\$0.05	12.1	1.14	\$0.00	1.0	0.09	1.23	0.5	
	Corporate operations & services	\$0.50	-			0.9	0.85	0.85	0.3	
	Invest Land & Local Taxes	\$3.00				0.9	5.08	5.08	0.2	
	Invest Fees & Insur	\$5.34				0.9	9.04	9.04	0.2	
Subtot& Range		8.99						16.44	0.24	9.07 ⁹
dSEA4 0.0	Finance cost estimate	\$69.9				1.0	131.68	131.6	0.16	
0.1	Cost of Government estimate	\$13.2 ⁷				0.9	22.47	22.47	0.2	
0.2	Production tax credit	\$-35.0 ⁸				0.0	0.00	0.00	0	
Subtot& Range w/o PTC		83.18						154.1	0.16	6.09
Project Totals SEA, Range and EROI		\$213.12						469.0	0.16	

Symbols: Tii = tech fuel use rate factor, T_E = tech fuel use intensity total, \$T = average economic value added for T_E, Eii = econ fuel use rate factor, E_E = econ fuel use intensity total, SEA = total energy used, dSEA# = change from prior level.

1. The value of electricity sales, for a capacity factor of 32% and market price for after tax net revenue of 11%;
2. Average economic energy intensity, E_{iW} from EIA data = 1.883kWh/\$, declining at ~1.24%/yr. over time;
3. Tii wt. factor for LCA fuel use, .03, gives the price of LCA measured fuel use in relation to E_{iW}, for the budgeted fuels it is 12.07, to give the energy value of purchased fuels based on cost of fuel oil, in relation to E_{iW};
4. Eii wt. factors assign above or below avg intensities. If all Eii's = 1.0 the table collapses to SEA4 = tot\$*E_{iW};
5. Input Range Estimates, are judgmental estimates for each line item, and underlined to indicate the accumulative range of variance for the total energy accounted for, as seen in Figure 7 bar chart;
6. Cost categories missing from the JEDI model[26] were given estimates;

Table 3. *Cont.*

7. Taxes on net revenue are 36% of net revenue, approximating the ratio of total US local, state and federal government costs to GDP, from an online calculator http://www.usgovernmentrevenue.com/yearrev2008_0.html;
8. The production tax credit considered in the financial model is assigned an E_{ii} of zero and not, considered as a transfer payment from other tax payers and not included in the cost totals here or considered as an energy source;
9. The accumulative internal EROI of 9:1 and external EROI of 6:1 indicate the energy available to society before and after including the basic operating costs of the economic environment, $dSEA4$.

3. Whole System SEA and EROI Estimate Models and Results

3.1. Method 1. SEA Table and 20 Year Average Costs

Table 3 shows our assessment of the business plan for the wind farm, beginning with the LCA_E energy content of 90.9 kWh/kW and the implied EROI of 31:1 for delivering the 2856 kWh output. From that we ask what else is needed and add energy requirements for successively larger parts of the business operations required to deliver the energy for sale. The accumulative EROI for each level is shown in column 9 and the SEA and EROI results are graphed in Figures 6, 7, 10 and 12.

The basic procedure for each item in the table starts with either column 1 or 3, a dollar cost or an energy cost. We assigned budget range estimates for all inputs as shown in column 8, with accumulative variances at each level shown underlined and graphed as error bars in Figures 7 and 12. The next step is to estimate values for T_{ii} and E_{ii} as above or below average and establish what value of $\$T$ (column 4) to remove from $\$E$ (column 1) in calculating E_E (column 6) using Equations 5 to 8 for possible overlap. It's important to note, that if it happens that $E_{ii} = 1$ then the values of T_E cancel out in Equation 8, making the equation for $SEA = T_E + (E_E - T_E)$. That shows that if you don't know much about the energy intensity of any item, finding some partial records of direct energy use to both add and then subtract in equal amounts, does not improve the estimate. So without doing a fairly careful study the simple estimate using $E_{ii} = 1$ for average energy use per dollar is implied. It also shows the need for empirical studies to develop other guideline intensity factors for E_{ii} and T_{ii} for various common types of businesses and expenses.

3.2. Summary of Method 1. Results

As more of the needed business operations are counted from SEA_0 to SEA_3 , and we count costs further removed from the high cost heart of the business operation, we find a succession of smaller changes in the partial estimates of EROI (Figure 6,7,8). When crossing the boundary from accessing the business's internal to external environment needs, going from SEA_3 to SEA_4 , quite large monetary and implied energy costs and uncertainties are found again, associated with financing, unpredictable net revenues and taxes. As a metaphor, it portrays the business operating as a fairly well defined ship navigating relatively large and unpredictable shifting seas of other things. The partial estimates of EROI decline from 31:1 at LCA_E to 9:1 at SEA_3 , with an increase of 350 % of in the energy use accounted for. It further declines to 6:1 at SEA_4 for an added 150% in the energy use accounted for.

One of the interesting points is how the intensity factor of $E_{ii} = 1.5$ (Table 3, col. 5, 2nd & 3rd line) was arrived at for the capital costs of the business. In an initial attempt to use realistic values, 1.5 was a

test value for using the Option 3 method of avoiding double count. On later examination it was discovered that the same answer would result if we treated T_E and E_E values as entirely separate (using the Option 2 method), using $E_{ii} = 0.9$ to represent only the untraceable economic energy for the supply chain business operations for the LCA_E technology package. The E_{ii} of 0.9 was estimated by taking the energy use totals from all the economic sectors provided by Costanza [12] that seemed associated with the least traceable energy uses for operating businesses, as a share of the total, around 90%. That avoids the potential of double counting by having a complete estimate of the traceable technology energy use, and an intensity factor scaled to estimate only the untraceable economic energy uses.

Figures 6 and 7 show the fractions of additional energy use accounted for and the corresponding fractional reductions in EROI. The technology energy use (LCA_E) accounts for 19.1% of the total, and the value of EROI that starts at 31:1 declines by 81% to 6:1 by SEA4. In Figure 7 you see EROI decreasing by smaller proportional steps from SEA0 to SEA3, but then at SEA4 decreasing by a larger step again, for the large environmental costs of financing and taxes. Figure 8 shows the estimates of the LCOE breakeven price for the electricity, rising from approximately \$.002/kWh at LCA_E to \$.076/kWh at SEA4. LCOE is shown for the partial cost estimates at each level, just as the partial estimates of EROI were based on partial assessments of the energy needed at each system operating level. We find that the LCOE substantially rises and EROI declines as we consider more of the business operations needed. The curves have different shapes because there is more energy per dollar embedded in the LCA_E and SEA0 business costs.

Figure 6. Annualized estimates of 20 yr energy uses, amounts added at each scale of business working unit, LCA_E to $dSEA4$. Accounting for all internal costs at $dSEA3$ and adding environmental costs at $dSEA4$.

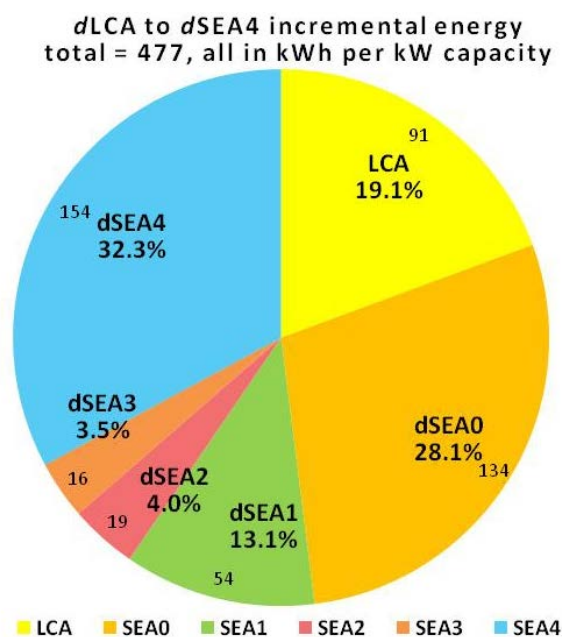

Figure 7. Percent change in EROI by scale of operations counted, LCAi to SEA4, error bars show accumulative variation for input ranges in Table 3. Accounting for larger scales has declining effect up to the point of adding the environment costs at SEA4.

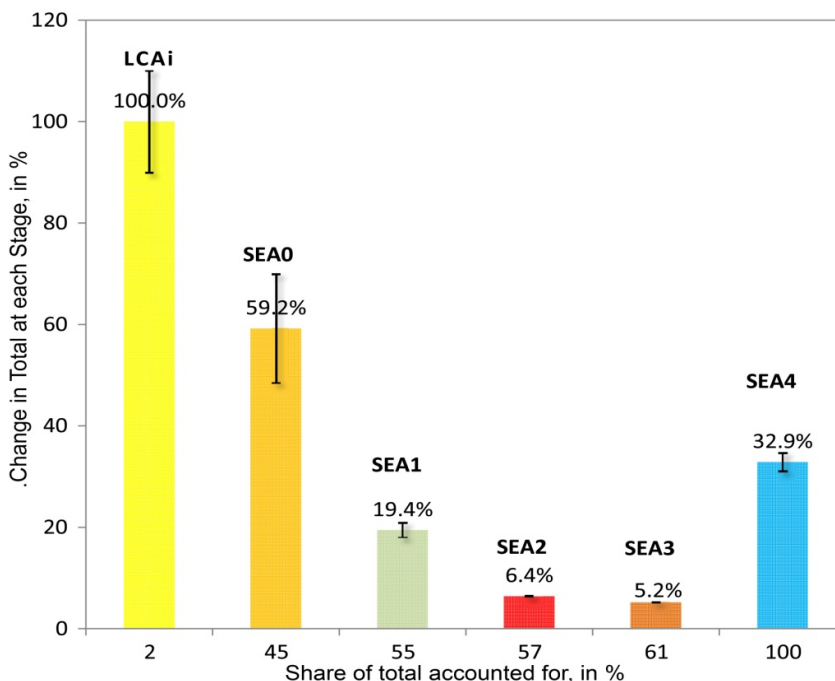
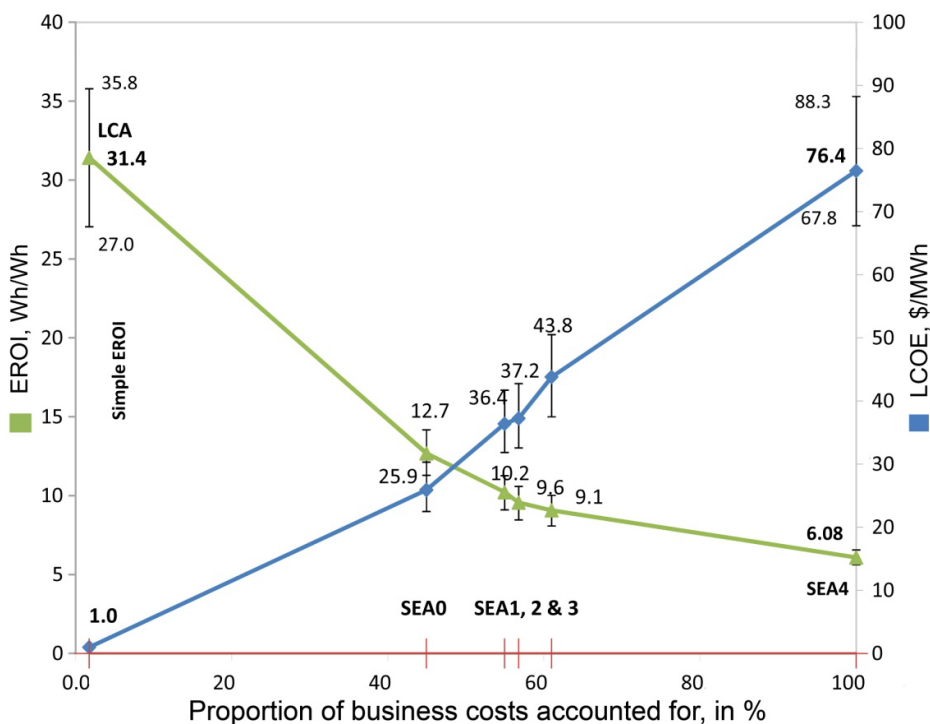

Figure 8. EROI ratios Wh/Wh decrease and LCOE \$ prices increase with increasing shares of the business accounted for. Error bars show the 25th and 75th percentiles for input variances in Table 2, showing uncertainty proportional to scale as would be expected.



3.3. Cash and Energy Flow Account Results

The cash and energy flow model lets us consider the business system as a financial planner would, but from both its dynamic financial model and energy model views. We use a discounted cash flow analysis to analyze monetary flows and for the energy flow model we use a somewhat simplified version of the linear model presented in Table 3. Figures 9 and 10 show the annual and cumulative revenues, respectively, for breakeven operation of the wind energy business. For the LCA_E level almost no cash flow is shown since the revenue required is only to pay for the 90.9/kWh of fuels estimated for the capital costs of one kW of generating capacity, the cost of purchasing the LCA_E estimated fuels to manufacture, install and operate the technology of the turbine.

The larger business costs for capital, installation and operating costs at SEA0, 1, 2 and 3 (all shown as the same line in Figure 9 and 10) start very negative for borrowing the capital costs, and turn positive the next year. The net energy flows (Figure 10) also start very negative as the larger costs are accounted for in SEA0, 1, 2 and 3 but due to the assumptions made shows a payback period of only about 1.5 years. The corresponding monetary payback period is almost 12 years. The differing assumptions used for the SEA4.0, 4.1 and 4.2 don't include the initial or operating costs and vary over time. A variety of good questions for how to represent the real energy and cash flows are raised.

By assuming a Production Tax Credit (PTC) subsidy the financial modeling suggests that the revenue gift is also an energy gain for the system, and an implied reduction in the energy needed to produce energy. It shows how standard financial assumptions need to be carefully examined, as physical processes don't change with accounting tricks. The effect is shown in Figures 9 and 10 as a dashed line reducing the annual cash flow for the first 10 years. The PTC assumption effectively reduces the investment payback period from nearly 12 years to almost 6 years. Of course, the PTC does not increase wind turbine output, but people not thinking about what they are measuring might confuse the tax credit as an energy grant, and show it as boosting the energy delivered to society.

Figure 9. Revenue for discounted costs and breakeven pricing: (a) Annual After Tax Cash Flow with NPV = 0, (b) Total Cumulative Cash Flow with NPV = 0. Both assume a 6% discount rate and show the initial effect of high first year of capital costs.

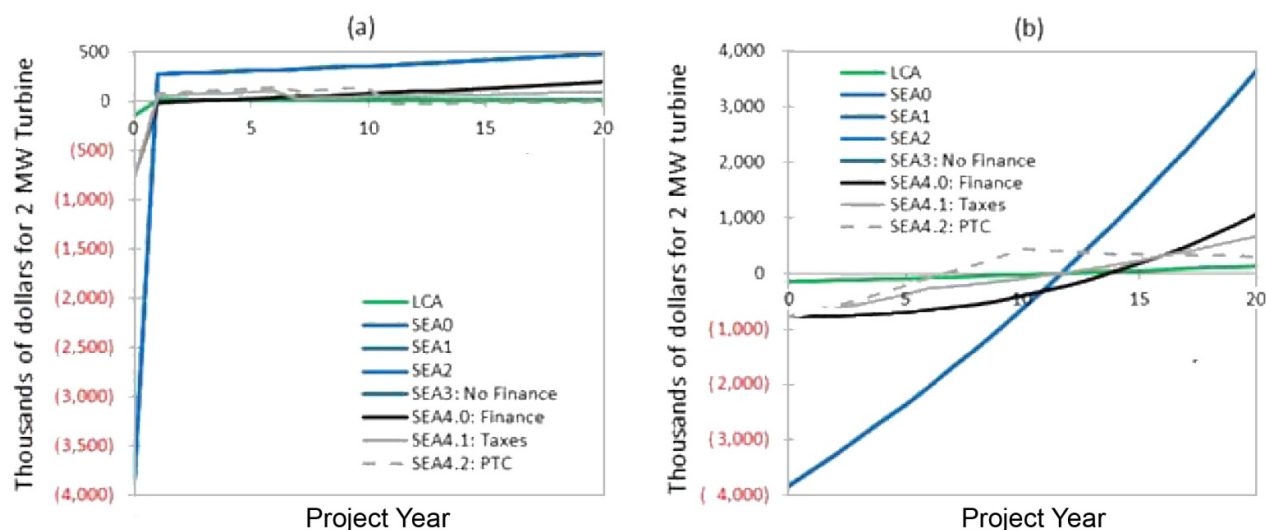
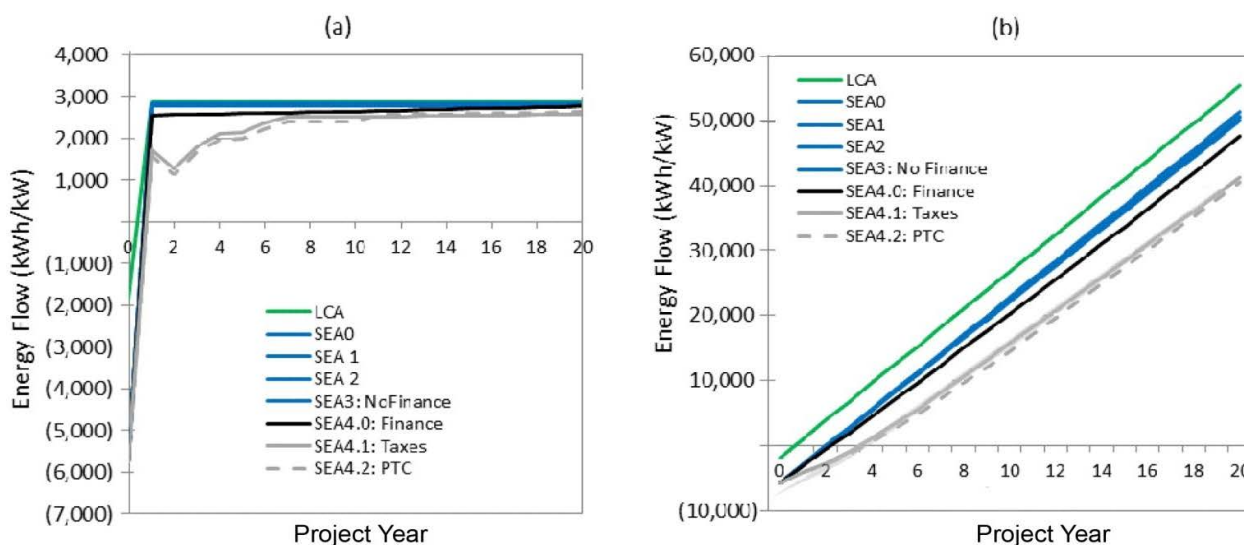

Figure 10. The (a) Annual Business Energy Flow and (b) Cumulative Business Energy Flow (kWh/kW) for each SEA level. The SEA4.2 (PTC) level is shown as if the tax credit was an energy gain to the business, though no energy is saved by it, showing one way common financial assumptions.



4. Interpretation, Application and Future Work

4.1. Whole System Comparative Value

To compare the energy productivity of our wind farm business model with other businesses, we use the world average GDP produced per unit of energy to define a new benchmark, monetary return on energy invested (MREI), measuring the income produced per unit of energy used (Equation 11).

$$\text{MREI} = \text{Revenue} / \text{Energy Cost} \quad (11)$$

The world average economic value added for energy use is $1/E_{iW}$ (see Equation 1 and 2). In Figure 11 bar-2 (100%) & bar-3 (95%) show, respectively, the world average revenue produced for the SEA4 level of energy use compared to the estimated revenue of the wind farm, estimated at SEA4 for 11% net revenue after costs and taxes. For general comparison bar-1(85%) shows the total expenditures at SEA4 and bar-4 (143%) shows an artificial “retail value” as if the wholesale price were marked up 50%. The wholesale MREI value for the electricity generated by the wind farm seems to be 5% below the world average for using that same amount of energy.

The Costanza data (Figure 1) indicated that businesses in the energy sector generally produce significantly higher than average economic value for the energy used (*i.e.*, lower than average energy intensity for the value added). Some of the model assumptions that might be changed to show the wind farm producing more economic value for the energy are (1) lowering the E_{ii} value of 150% of average for the technology costs, (2) raising the estimated wholesale market price of electricity from \$83/MWh to show a greater profit margin than 11%, (3) raising the rate of wind utilization from the estimated capacity factor of 33%, and (4) distributing the capital costs over more years. It might also indicate that the estimated US combined tax rate of 36% on net revenue is higher than the world average. That

raises the question of whether societal overhead costs determine what kinds of businesses can prosper in a given society. A variety of societal overhead costs in the US do seem to have been persistently increasing, such as environmental mitigation costs, maintenance costs for increasingly complex urban infrastructure, healthcare, retirement and education, *etc.*. This one benchmark, then, seems to raise a wide variety of important questions. The accuracy of the measure itself is likely to be improved with use. What's interesting is seeing all those questions as connected by one number, perhaps indicating this is as good way to look at the interaction of financial, energy and environmental variables.

Figure 11. Monetary Returns on Energy Invested (MREI), A possible comprehensive energy performance benchmark. Comparing energy costs and benefits per kWh installed, cases (a) Total operating cost (b) Average GDP for energy used, (c) Wholesale price of for electricity generated (w/ 11% profit), (d) Wholesale value with a 50% mark-up

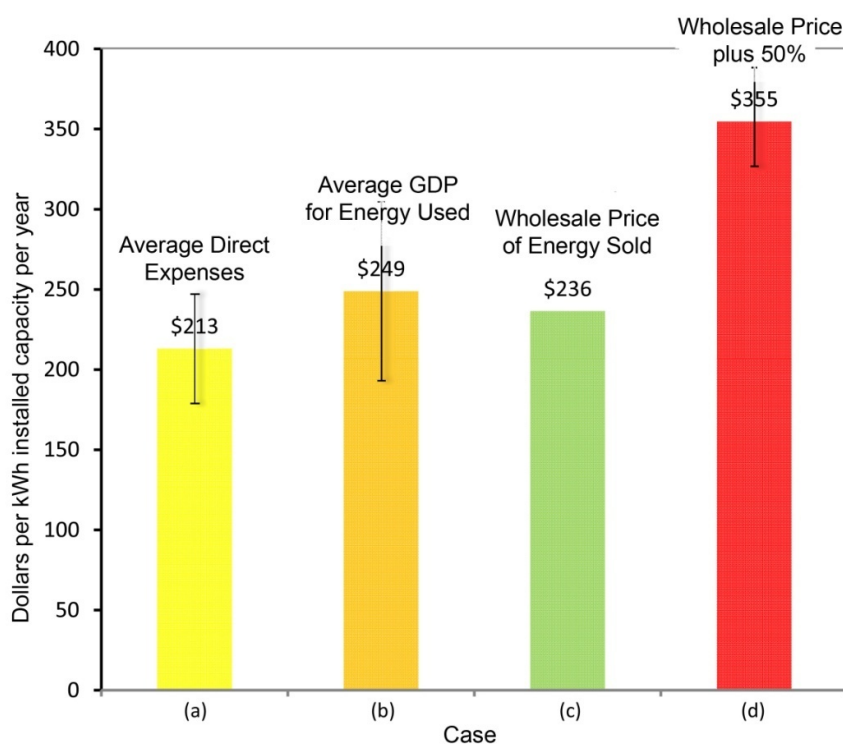

4.2. Whole Environmental Assessment

Life cycle assessments, whether using LCA for technology impacts or SEA for business energy use as whole systems, help people understand how we organize economic activity and interact with our environment. Environments themselves are naturally moving targets, making whole system assessment partly a matter of finding your place in a long story of change. Our historic two hundred year economic experience of accelerating growth, as technology made resources ever cheaper, is now reversing. Increasing resource costs are due to declines in the rate at which new resources are being found, rising competition for them, and also the increasing physical costs and complexity of extraction. Those kinds of reversals in the direction of change are often possible to clearly identify, even from anecdotal information when consistent definitions and patterns of change are lacking. Simply a lag in

the rate of finding new reserves is clear evidence of it, as occurred for world oil reserve discoveries in the 1950's [31] (see Figure 2). Reversal in the rate of increasing productivity of resource investment is often irreversible, as resource development is generally a comprehensive search, and so indicates natural development limits being faced.

SEA studies provide a way for businesses to physically measure their total exposure to some of these environmental changes. One could also use SEA studies to measure the historical trends in EROI to better identify historical developmental processes that were occurring, and so better project future energy or other resource needs, degrees of environmental resistance and the kinds of business models needed in the future. Business growth strategies change considerably when moving from limitless expanding opportunity to seeking a level of stability, for example. Being able to observe that or other changes in the directions of change in the economic environment could greatly affect business operating conditions and decision making and in the advice given to investors generally.

In the 1750's the difference between heat and temperature was first recognized by Joseph Black, finding that temperature is an energy intensity, not an quantity, but that an intensity could be used to calculate heat as a quantity if it was integrated over a defined volume as a boundary. His friend James Watt learned of the idea and applied it to his work inventing steam engines a decade later. It changed the world. SEA represents a somewhat similar change in measurement science, from thinking about counting visible energy uses by pre-defined accounting category to totaling the functional energy needs for a business as a whole working unit operating in the business environment. It may not create businesses with ever greater energy impact, repeating Watt's magic for creating efficient machines and proliferating energy use. It does define a way to apply the quantitative relationships of energy physics to economic systems, though, and so to apply thermodynamics, the conservation laws, entropy, *etc.*, to business and economic questions. That could change our way of thinking about them, and be very informative about how to make them sustainable.

One immediate use of SEA measures might be for allocating government subsidies according to measured performance for delivering sustainable energy to society. It could guide the design and use of tax credits, creating rating systems to help guide intelligent investors or to prioritize research policy goals. It might similarly be used to help allocate tax penalties, to more fairly distribute societal costs of eliminating CO₂ pollution in response to climate change or to facilitate other resource depletion policies. One policy objective might be to restrict the use of supplies of presently cheap but increasingly costly diminishing resources, reserving their use for making higher cost but sustainable resources usable.

That EROI depends on system overhead costs should be an "eye opener". The sustainability of a society built for cheap energy and low overhead is brought into question if its unproductive overhead costs steadily increase as its resources become progressively more expensive. That tipping point can be approached by being simply unresponsive, by "doing nothing". Just continuing to make desirable but unproductive luxuries and infrastructure essential for societal functions, until maintaining it becomes unaffordable, a path of retreat may not then exist. The original study of this relationship, the examination the EROI an advanced technological society must have to operate, was by Hall et. all. [32], and is being revised for inclusion in this volume. Using empirical methods like SEA, which rely on using the organization of systems in their natural form to define their physical measures, could add

considerable validity and precision to such estimates. That could be quite valuable for making the informed choices about the increasing complexities of the world we need to better understand [33].

4.3. Pros and Cons of SEA Methodology

It's surprising that relatively easy rough estimates turn out to be more accurate than time consuming efforts relying on precise measures. In this study, after all the effort we went to, the best total value we found for the energy needed for the wind farm differs by 500% (Equation 12) from the method serving as the world standard for estimating the same thing. That total, though, is surprisingly only 15% different from using the simplest possible method of making the same calculation, assigning the global average energy intensity of money to the total project cost (Equation 13). The great effort we went to did change the result much from what we could have assumed from the start.

$$EROI_{LCA} / EROI_S = 31.42/6.09 = 516\% \quad \text{more than ISO standard} \quad (12)$$

$$(\$E_{tot} * E_W) / SEA4 = (\$213 * 1.87) \text{ kW} / 465 \text{ kW} = 84.5\% \text{ or } 15.5\% \text{ less than average} \quad (13)$$

It clearly shows that using money to measure the real scale of economic energy use can be both less precise and much more accurate, than carefully counting up traceable energy uses. The great majority of economic energy use comes from the delivery of unreported services scattered all over the whole economic system making them untraceable. That the change so great it indicates not asking the right question, what is called a Type III error. In part it implies that the energy use estimation procedure should be reversed, beginning with the easier but more inclusive method to start. Easy preliminary estimates based on econometric measures would be supplemented with accounts for traceable energy uses affordable. As traceable energy uses are such a small part of the total, the amount of effort to identify them in most cases would have rapidly diminishing returns for altering the total.

That average money uses will have average energy content, and for lacking any better information about most money uses and their energy content, results in our needing to begin relying on money as a measure of energy use. Even if it will take time to understand it, the implication is that money is actually a real form of energy currency, both physically and for our information models, a sort of surprising result. Money is considered as the economy's universal resource. That on average it seems to be a direct measure of our use of nature's universal resource too, indicates that energy is the main resource used to deliver what people value. It seems to make the question of how much energy is used be the same as asking how much of the economy is used. That the scale of money use generally reflects the scale of energy use also clearly implies that our common perception of "decoupling" between money and the environment is a complete illusion. From seeing where the missing energy uses were found, in the branching trees of services hidden from view, the belief that money has no energy content evidently comes from our trusting our lack of information about it.

Going to the extra effort to determine how much above or below average your economic energy use may be will still be warranted in lots of cases, though, like if you have a carbon pollution tax bill to calculate, for example. Production engineers will also still get significant value from understanding the real costs of their own production technology choices too, of course, as obtained by careful LCA studies. Developers and investors will also still want to know as much as they can about things like how much their investments expose them to threatened resources.

How SEA appears to get the scale right is by 1) having a reproducible and improvable way to define the full extent of what is to be measured, using the natural boundaries of the system measured, (2) relying on the world economy to uniformly allocate energy uses by setting a world price for the available supply, and so providing a way to start estimates of energy use for items in a budget, and (3) having the scale of missing and untraceable information so very large it would be unimaginable to get a better estimate the traditional way. Input-output models [11,13,16,20] as illustrated in Figure 1 show widely varying energy intensity, and so a need to develop ways to assign a variety of different intensities to different things to improve the SEA method. Except as a share of the whole economy's impacts, indicated by dollar value, it's quite hard to say what impacts any product would have the way "green" products often labeled as having less impact but costing more to deliver. It's commonly believed they would be the products produced locally, and buying local would help steer the economy away from relying on non-renewable energy. How the SEA method advances those interests is by allowing a better understanding of whole system energy costs, exposing a business to higher or lower opportunity costs or environmental risks to itself or others. In the economy of the present, though, local products are often more expensive and so implicitly more energy intensive, for not having economies of scale and specialized content. Until those kinds of differences are better understood, absent other information, "about average" is a better estimate for the implied energy use of spending than "zero". As much as prompting a search for better ways to estimate the totals, it also suggests that the general subject of complex organization in environmental systems, that few people seem even aware of, is important for general public discussion.

We think the SEA method makes a useful contribution to defining quantitative physical measures for business systems in general. It defines a business by the organization of its working parts, considered at a stage of its development in a changing environment, rather than as columns of figures arranged in functionally unrelated categories only leading to a "bottom line". By using a method of exhaustive search using a repeated neutral question about what's missing, the SEA method empirically locates the functional boundary of whole systems. That's a possible model for how to calibrate reproducible physical measures of various kinds of distributed systems, using their own organization as a boundary. The new approach makes such measures comparable and provides a sound basis for evaluating alternate business model choices. Thus SEA has distinct advantages relative to alternative methods of analyzing the energy inputs and outputs associated with complex environmental systems.

4.4. Future Work

The method as presented provides a fairly simple common standard measuring business energy use, but it will take some time and effort to adapt it for widespread practice. Various industries might discover different ways it needs to be applied to their needs, and large scale econometric studies of different kinds are clearly needed as well. Questions like how to compare the utility of different fuels would need to be addressed. There might be a useful relation between the world average GDP/kWh we have used to measure economic value of energy, and the ecological concept of "emergy" in ecological systems, for example.

The mismatch between when wind and solar energy are available and when they are needed seems likely to require analysis of industrial systems of larger scale than individual businesses, for example.

Lots of development problems are like that, needing to apply to unique industrial and natural environments, and to current stages of technological and human cultural development. In some regions local wind energy integration solutions have emerged. For example, Denmark uses pumped hydropower within Scandinavia for storage of excess electricity and exports to other markets. In the Texas grid (Electric Reliability Council of Texas), 4.9% of the electricity in 2008 was from wind power, and the large capacity of natural gas generators on the grid has thus far enabled relatively easy integration of wind. However transmission constraints have restricted wind power flow at many times to lower the capacity factor by up to 10%. Eventually at very high penetrations for wind energy (over 20% of total electricity), newer chemical or thermal battery systems may need to be employed. However, installation of natural gas combined cycle systems may serve the need to mitigate the intermittency of wind at the cheapest cost. Thus, if the energy inputs and/or EROI of each component added to the electric grid is known, one can estimate the EROI of the supply system as a whole for matching the demand.

One strategy for increasing average wind output is evident in the high energy cost of all the initial development costs that scheduled to be repeated every 20 years. Further study would compare different replacement rates and net returns. We might changing from assuming discount rates for the value of money to study business models with a built in cost of savings, to become self-sustaining and self-financing over time. This relates to the long discussion of whether to invest in short or long term development, sometimes in terms of economic arguments over what discount rate to assume in cost-benefit analysis [34]. Those economists choosing a low discount rate tend to find a net benefit for investing in avoiding ballooning long term future costs, such as climate mitigation and resource depletion. Those choosing to make business decisions assuming high discount rates find less benefit in long term investments, but their businesses might be less likely to be sustainable too.

Another area of research needing attention is the basic relation between financial information and the physical economy. It's remarkable that world GDP so closely tracks world energy use, and shows so little sign of sudden shifts in direction. That is not the case for historic changes in asset values, though, demonstrating a tendency for financial markets to develop great bubbles of misinformation about future economic performance. One can clearly see the difference between grounded and ungrounded economic measures in the way the valuation of the US stock market wanders all over and the physical value of the economies has changed relatively smoothly over time. For forty years world energy use has also followed smooth curves in proportion to world GDP. While US GDP and energy use have followed different trends over the period they have also been self-consistent. The US stock market has not followed any of the physical economy trends, though, but seemingly wanders by itself [22], (see Figures 1, 4, 5).

Since economic measures that closely track energy use and move independent of it seem common, understanding why different markets do and do not provide reliable whole system measures is important for having confidence in using money as a physical measure. Lots of budget items like financing, profit projections, tax rates, subsidies, returns to investors or discounted values might all introduce speculative information to distort a physical system assessment. Our approach to avoiding the misuse of money as a physical measure was to be careful in assessing individual cost items. For estimating tax burdens we used shares of the total cost of government in relation to the national economy (rather than special rates for special purposes). For profit rates we used a generic rather than

a theoretical profit requirement. At least as important as these adjustments to fit the method to the problem seems to be to always treat economic measures of energy loosely, perhaps true to scale but read as if calculated to one significant digit rather than two or three.

Also needing further study, of course, is the real meaning of “average” as it applies to the embodied energy of money, and of how to tell what kinds of spending are above and below average. We’ve assumed world energy use per dollar to be uniform, so studies of the non-uniformities are needed. Among other ways to study that is a network analysis of how money circulates. For example, if in a month a person gives money to 200 different businesses, and each business receiving the income gives money to 200 different people, then in three months there are $200^3 \times 200^3$ partial recipients of any dollar spent. That cascade results in 6.4×10^{13} potential end recipients in three months. If you assume there are 5 billion economically active people on earth, each one might receive part of a single dollar spent three months earlier by an average of 13 thousand different paths! It’s confusing math, but may be fundamentally important for understanding how our economies work, and how to measure them. A network analysis examining the “degrees of separation” between energy uses communities that add more or less value to energy, and add to the understanding of product space relationships and community development pathways [35]. Finding how to reducing energy use without reducing comfort is probably not done just by just changing one’s spending from one thing to another. It’s more likely done by earning less but spending on things of more value, a cultural change.

5. The Scientific Questions

The traditional method of measuring the environmental impacts of businesses appears to count only the resource needs businesses record in the process of controlling machines and equipment that are not self-managing. That has left uncounted the resource needs for supporting employees, managers and the services they use to operate business. We showed one way to solve that accounting problem, but it identified such a large discrepancy in results, an increase to five times the original estimate, that it suggests there is something wrong with how the question was asked, a Type III error. In part that prompted a change in our perception of money as a physical measure of environmental impacts, as discussed in Section 4.3. It also prompts a question about how common it is that scientific models are based on available information, instead of assessing the working processes said to be depicted.

That both professionals and the public appear to be quite unaware of the scale of energy use required for common purchases. Simple conversions of the ratios of world GDP, energy use and CO₂ show that average expenditures like a \$6 glass of wine consume the equivalent of 6 times the volume of gasoline in energy and produce around 16 times its weight in CO₂. The decimal points matter less than the wholly unappreciated scale. It exposes how our intuitions, and scientific explanations, rely so heavily on the information at our disposal, and how that hides the dimensions and behavior of the environmental systems we are part of. The implication is that we have a great need to begin getting our information about whole system effects in some new ways, and other kinds of environmental models may contain the same error of accounting for environmental processes as controlled by where we find records of them, rather than by how the animating and inanimate parts need to work together.

The wider implications of changing any widely accepted scientific method or its use for guiding world environmental policy, are well beyond what can be addressed here. So too are the wider

implications of looking for practical methods for defining measures to fit the form of the thing being measured and checking to see what common measures do and do not. The origin of the discovery, though, is interesting. It seems to be a result of pursuing an accounting problem that required finding a way to treat complex units of organization in the environment as physical subjects, sufficiently well defined to physically measure. Most of the extensive branching trees of energy use needed to bring products to market are hidden from view, and so have gone unobserved and unrecorded. That was the problem that made the difference, identifying a classic “fat tail” distribution that was not visible from the available data. So from the view of information models those energy uses disappeared, until we considered the physical causations involved as “receipts” for the real costs of the services provided and had the luck of finding what seems like a good way of estimating them.

Part of the reason to mention these complex issues, but also keep the discussion short, is that people are accustomed to thinking of physical processes in the environment as following formulas, and they don't. Our cultural awareness of how complexly organized natural systems work is very undeveloped. The systems of nature seem much better described as local developmental processes, having parts that change everywhere at once, following their own emerging dynamics as they respond to local conditions. Environmental systems mostly have actively adaptive parts, and their collective behaviors reflect how new directions of contagious development emerge, first opening up ever greater and then less opportunity for themselves. Human interests and inventions are like that, “stormy”, but then even the weather is too. So they only appear to follow formulas when their ways of changing are steady for a while, but can also change direction fairly quickly sometimes with little notice for those not knowing what to watch for. For our measures and theories to fit nature better we would need to both shift our focus from considering natural systems by where the information collects, their “symptoms”, to assessing their working processes of “development” that show how they work, while also of course keeping watch for how their regular behaviors may quickly change direction.

6. Conclusions

Methods for determining the energy costs of business and the energy needed to produce energy, EROI, have suffered from the difficulty of defining what to measure. The standard LCA method is well defined for assessing the traceable energy costs of business, associated with technology. Most of the energy costs of businesses are not readily traced so LCA has not counted them. SEA corrects that using a combination of “bottom up” and “top down” approaches for assigning shares of world energy use, based on shares of world economic product. That revealed a large discrepancy between the two methods, and many categories of instrumental energy use that were going uncounted.

Using SEA and starting with data categorized by where the records were found, we defined a method of tracing causal links and reassigning energy uses found elsewhere, to “disaggregate” the original categories and reconstruct the functional energy needs of the business operations paying for them. Combining the two kinds of energy information required combining precise but incomplete measures with imprecise but comprehensive measures. We used hybrid accounting to do that, not unlike that used for LCA, but asking a different question. Instead of identifying the task as collecting information from predefined categories, we identified the task as objectively defining a whole system of connected operations so they could be physically measured.

To remove the subjectivity of defining what to measure we asked the question of what else is needed and followed the physical causations to let the natural definition of the system determine its own boundary. It identified the business as a whole system of controlled and controlling parts with a functional boundary of energy needs. That is what located the missing information to account for. We used that reconstructed network of functional energy requirements to define both an energy measure of the business and the physical extent of its working parts, identifying the business as an organizational unit of the environment in its natural form. Thus the method of determining its total energy use also uniquely identifies the individual complex system using the energy, allowing it to be referred to elsewhere as well.

The method that results is straight forward, well defined and can be improved. We presented it with some repetition to demonstrate the search strategy it is based on and discuss different views. We hope people take the obvious shortcuts possible but also look for where the short cuts leave things out and a search strategy or reference notes on what may be missing could be added. In the end the SEA method is not a fully defined procedure, but describes a learning process for discovering the full extent of the working parts of a business as an environmental system. Basing the measure on locating that as the functional boundary of the business, for assessing everything within it, is what turns the qualitative measures for the separate parts into a quantitative physical measure of the business as a whole, for its own boundary.

We feel we have demonstrated a more accurate way to measure and understand the real scope of the energy costs of business, consumer and development choices. We also see it as a framework for doing original scientific research on locally organized systems. It's a procedure for defining a complex system by its boundary, starting a search from one instrumental point, that provides a view of its separate worlds of interior and exterior relationships. It is quite tentative, of course, but the hope is that this way of defining businesses as measurable physical systems will make it possible for the various sciences to independently study the same physical subjects, such as the relationships between money choices and the environment. Consistent with the view that a business works as an individual unit of organization that works as a whole in a complex natural world, a way to refer scientifically to complex systems as whole working units will perhaps allow wider collaboration for advancing the general desire to better understand both.

Acknowledgements

Even a long hard uphill push against what seems like resistance from every quarter has its angels of mercy and good luck to be grateful for. We'd like to thank all the prior contributors to the EROI discussion, especially Charlie Hall, for forging the way and making a subject so critical to the sustainability of the earth's resources acceptable to discuss in "polite society". As co-authors, we also wish to thank each other too and our institutional support, for being strong advocates of views that, that while breaking up the team also forced a much more complete analysis of the scientific questions and a paper conforming to higher than usual standards. What we most have to thank is the accident of our own passion for the ideas that made the years of effort that led to this paper something compelling and quite worth the sacrifices and the time.

Nomenclature

SEA or E_{IN} - total system energy use
 $dSEA$ - change from prior SEA level
 E_{iW} - world average energy intensity per dollar GDP
 $\$E_{jk}$ - business costs of k th item in the j th business unit
 E_{Ejk} - economic energy of k th item of j th business unit
 E_{ii_j} - relative economic fuel use intensity factor
 $\$T_{jk}$ - energy use value of k th item of j th business unit
 T_{Ejk} - tech energy of k th item in the j th business unit
 T_{ii_j} - relative technology fuel use intensity factor
 E_{out} - energy produced
 EROI - energy return on energy invested
 LCOE - levelized cost of electricity
 MREI - monetary return on energy invested
 LCA - life cycle assessment
 LCA_E - life cycle assessment energy
 TEA - total environmental assessment
 PTC - production tax credit
 NPV - net present value
 IRR_e - internal rate of return for energy

Abbreviations

wt	weight
est	estimate
tot	total
val	value
avg	average
yr	year
equip	equipment
invest	investment
insur	insurance
tech	technology

ACM class: E.0; H.1.0; J.2; J.4–(acm.org)

MCS class: 28D05; 18A15; 03C35–(ams.org)

References and Notes

1. Hall, C.A.S.; Cleveland, C.J.; Mithell, B. Yield per effort as a function of time and effort for United States petroleum, uranium and coal. In *Energy and Ecological Modelling, Symposium of the International Society for Ecological Modeling*; Mitsch, W.J., Bosserman, R.W., Klopatek, J.M., Eds.; Elsevier Scientific: Louisville, KY, USA, 1981; pp. 715-724.
2. Henshaw, P. F. *SEA Resource materials, notes and discussion*. author website, 2011. Available online: <http://Synapse9.com/SEA>
3. Cleveland, C.J.; Kaufman, R.K.; Stern, D.I. Aggregation and the role of energy in the economy. *Ecol. Econ.* **2000**, *32*, 301-317.
4. Costanza, R. Embodied energy and economic valuation. *Science* **1980**, *210*, 1219-1224.
5. Cleveland, C. Net energy analysis. In *Encyclopedia of the Earth*; Environmental Information Coalition (EIC): Washington, DC, USA, 2010; Available online: http://www.eoearth.org/article/Net_energy_analysis (accessed on 9 August 2011).
6. Guinée, J.B. *Handbook on Life Cycle Assessment: Operational Guide to the ISO Standards, Eco-Efficiency in Industry and Science*; Kluwer Academic Publishers: Norwell, MA, USA, 2002.
7. King, C.; Henshaw, P.; Zarnikau, J. *Defining a Standard Measure for Whole System EROI Combining Economic "Top-Down" and LCA "Bottom-Up" Accounting, Paper ES2010-90414*. In *Proceedings of the ASME 2010 4th International Conference on Energy Sustainability*, Phoenix, AZ, USA, 17–22 May 2010.
8. Henshaw, P. *TEA-Total Environmental Assessment Method*. American Center for Life Cycle Assessment: Boston, MA, USA, 2009; Available online: <http://www.synapse9.com/pub/ACLCA09-TEA.htm> (accessed on 9 August 2011).
9. Henshaw, P.F. Complex systems. In *Encyclopedia of the Earth*; Environmental Information Coalition (EIC): Washington, DC, USA, 2010; Available online: http://www.eoearth.org/article/Complex_systems (accessed on 9 August 2011).
10. Wiser, R.; Bolinger, M. 2008 *Wind Technologies Market Report*. Energy Efficiency and Renewable Energy office of the US Department of Energy: Washington, DC, USA, 2009.
11. Treloar, G.J.; Love, P.E.D.; Faniran, O.O. Improving the reliability of embodied energy methods for project life-cycle decision making. *Logist. Inf. Manage.* **2001**, *14*, 303-317.
12. Costanza, R.; Herendeen, R.A. Embodied energy and economic value in the United States economy: **1963**, **1967**, and **1972**. *Resour. Energy* **1984**, *6*, 129-163.
13. Carnegie Mellon University Green Design Institute. *Economic Input-Output Life Cycle Assessment (EIO-LCA) Model [Internet]*; Available online: <http://www.eiolca.net> (accessed on 9 August 2011).
14. Kubiszewski, I.; Cleveland, C.J.; Endres, P.K. Meta-analysis of net energy return for wind power systems. *Renewable Energy* **2009**, *35*, 218-225.
15. Hall, C.A.S.; Cleveland, C.J.; Kaufman, R.K. *Energy and Resource Quality: The Ecology of the Economic Process*; Wiley: New York, NY, USA, 1986.
16. Zarnikau, J.; Guermouche, S.; Schmidt, P. Can different energy resources be added or compared. *Energy* **1996**, *21*, 483-491.

17. Smil, V. *Energy in Nature and Society: General Energetics of Complex Systems*; The MIT Press: Cambridge, MA, USA, 2008.
18. Hendrickson, C.T.; Horvath, A.; Joshi, S.; Klausner, M.; Lave, L.B.; McMichael, F.C. Comparing Two Life Cycle Assessment Approaches: A Process Model vs. Economic Input-Output-Based Assessment. In *Proceedings of the International Symposium on Electronics and the Environment*, San Francisco, CA, USA, 5–7 May 1997.
19. Cleveland, C.J. Net energy from the extraction of oil and gas in the United States. *Energy* **2005**, *30*, 769-782.
20. Bullard, C.W.; Penner, P.S.; Pilati, D.A. Net energy analysis: Handbook for combining process and input-output analysis. *Resour. Energy* **1978**, *1*, 267-313.
21. Odum, H.T. *Environment, Power and Society for the Twenty-First Century—The Hierarchy of Energy*; Columbia University Press: New York, NY, USA, 2007.
22. Henshaw, P.F. Why efficiency improvement causes growing consumption. *Biophys. Econ.* **2009**; Available online: www.synapse9.com/pub/EffMultiplies.htm (accessed on 9 August 2011).
23. Pimentel, D.; Patzek, T.W. Ethanol production using corn, switchgrass, and wood; Biodiesel production using soybean and sunflower. *Nat. Resour. Res.* **2005**, *14*, 65-76.
24. Pradhan, A.; Shrestha, D.S.; van Gerpen, J.; Duffield, J. The energy balance of soybean oil biodiesel production: A review of past studies. *Trans. Am. Soc. Agric. Biol. Eng.* **2008**, *51*, 185-194.
25. Elsam. *Life Cycle Assessment of Offshore and Onshore Sited Wind Farms*; Elsam Engineering A/S, Vestas Wind Systems A/S: Fredericia, Denmark, 2004.
26. NREL. *JEDI (Job and Economic Development Impact) Wind Energy Model*; Energy Efficiency and Renewable Energy office of the US Department of Energy: Washington, DC, USA, 2009; Available online: www.nrel.gov/analysis/jedi/about_jedi_wind.html (accessed on 9 August 2011).
27. EIA. *International Energy Outlook*. Energy Information Administration: Washington, DC, USA, 2009; Available online: [http://www.eia.doe.gov/oiaf/ieo/pdf/0484\(2009\).pdf](http://www.eia.doe.gov/oiaf/ieo/pdf/0484(2009).pdf); and data tables Available online: http://www.eia.doe.gov/pub/international/iea2006/iea_2006.zip (accessed on 9 August 2011).
28. Gupta, A. Empirical look at global efficiencies-straightforward empirical analysis of 131 countries. *Biophys. Econ.* **2009**; Available online: http://web.mac.com/biophysicalecon/iWeb/Site/BPE%20Conference_files/Download%20Gupta.pdf (accessed on 9 August 2011).
29. Henshaw, P.H.; King, C.; Zarnikau, J. Wind Farm Excel Chart Model. authors' notes [*Internet*], 2010; Available online: http://www.synapse9.com/pub/SEAModel_EROIWind.xlsx (accessed on 14 October 2011).
30. *@Risk for Excel, version 5.5.1*; Palisade Corporation: Ithaca NY, USA, 2010; Available online: <http://forums.palisade.com/ShowPost.aspx?PostID=1978> (accessed on 9 August 2011).
31. Day, J.W.; Hall, C.A.S.; Yáñez-Arancibia, A.; Pimentel, D.; Ibáñez Martí, C.; Mitsch, W.J. Ecology in times of scarcity. *BioScience* **2009**, *59*, 321-331
32. Hall, C.A.S.; Balogh, S.; Murphy, D.J.R. What is the minimum EROI that a sustainable society must have? *Energies* **2009**, *2*, 25-47.

33. Tainter, J. *The Collapse of Complex Societies*; Cambridge University Press: Cambridge, UK, 1988.
34. King, C.W.; Webber, M.E. Methodology for Calculating the Ability of Renewable Energy Systems to Manufacture Themselves, Paper ES2009-90026. In *Proceedings of the ASME 3rd International Conference on Energy Sustainability*, San Francisco, CA, USA, 19–23 July 2009.
35. Hidalgo C. A., Klinger B., Barabási A. L., Hausmann R. The Product Space Conditions the Development of Nations. *Science*, Washington DC, USA, 2007, 317 (5837), 482-487.
36. IEA Data Services. 1971-2008 World Indicators. *CO₂ Emissions from Fuel Consumption*. International Energy Agency: Paris, France, 2010. Available online: <http://data.iea.org/ieastore/statslisting.asp> (accessed on 9 August 2011).

Appendix I—World Economic Energy Use

Date	World GDP PPP, Energy and Energy intensity			
	World Quad btu TPES	GDP PPP Billion 2000\$	Intensity Kbtu/\$ PPP	Intensity kWh/\$ PPP
1971	231,081	17,540	13.17	3.86
1972	242,333	18,463	13.13	3.85
1973	255,371	19,705	12.96	3.80
1974	256,863	20,251	12.68	3.72
1975	258,671	20,644	12.53	3.67
1976	272,856	21,709	12.57	3.69
1977	282,560	22,642	12.48	3.66
1978	293,662	23,648	12.42	3.64
1979	302,742	24,571	12.32	3.61
1980	301,883	25,098	12.03	3.53
1981	299,742	25,532	11.74	3.44
1982	299,878	25,753	11.64	3.41
1983	303,257	26,542	11.43	3.35
1984	315,165	27,702	11.38	3.34
1985	323,746	28,669	11.29	3.31
1986	330,516	29,692	11.13	3.26
1987	342,614	30,757	11.14	3.27
1988	354,538	32,094	11.05	3.24
1989	360,368	33,254	10.84	3.18
1990	366,530	33,357	10.99	3.22
1991	370,119	33,815	10.95	3.21
1992	370,045	34,556	10.71	3.14
1993	373,286	35,314	10.57	3.10
1994	376,420	36,555	10.30	3.02
1995	385,904	37,830	10.20	2.99
1996	395,980	39,354	10.06	2.95
1997	399,490	40,993	9.75	2.86

Table. Cont.

World GDP PPP, Energy and Energy intensity				
Date	World Quad btu TPES	GDP PPP Billion 2000\$	Intensity Kbtu/\$ PPP	Intensity kWh/\$ PPP
1998	401,860	42,085	9.55	2.80
1999	409,775	43,674	9.38	2.75
2000	418,625	45,761	9.15	2.68
2001	420,069	46,940	8.95	2.62
2002	429,289	48,349	8.88	2.60
2003	444,602	50,267	8.84	2.59
2004	465,820	52,884	8.81	2.58
2005	477,336	55,438	8.61	2.52
2006	489,893	58,466	8.38	2.46
2007	502,920	61,748	8.14	2.39
2008	512,286	63,866	8.02	2.35

To characterize the world economic energy intensity it is helpful to show the raw data and ratios for world GDP (PPP) and TPES purchased energy use from the IEA [36]. Similar world data is available from the US EIA[27] from 1980, showing the same average decay rate of energy intensity over time of 1.3%/yr.

Figure A1. World Economic Intensity, kWh/\$ PPP (blue) with Exponential Fit (yellow): Decay rate trend (~1.3%/yr) (Table 4 in [29]).

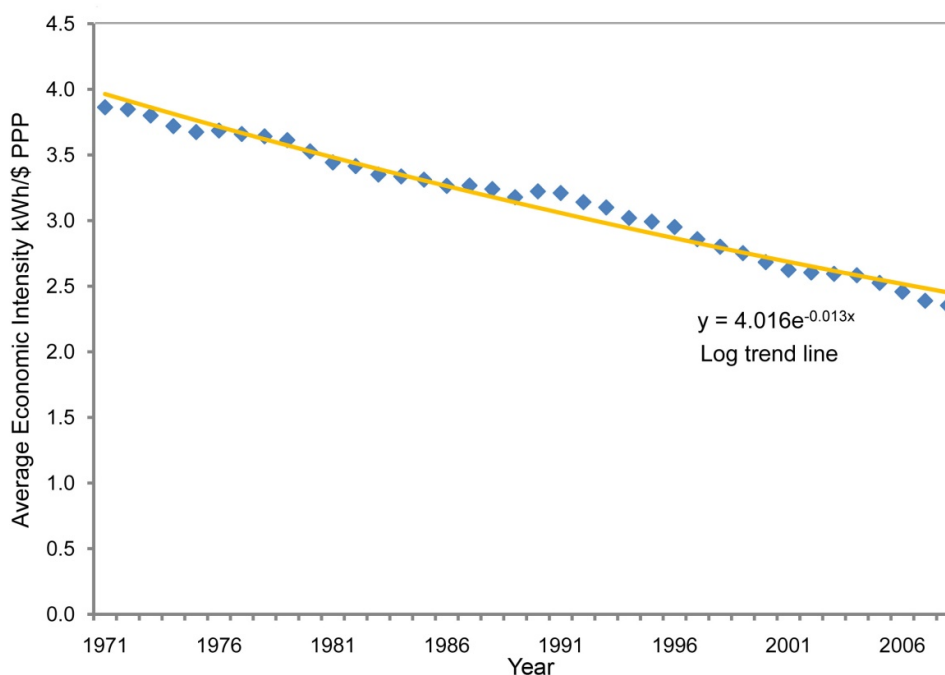
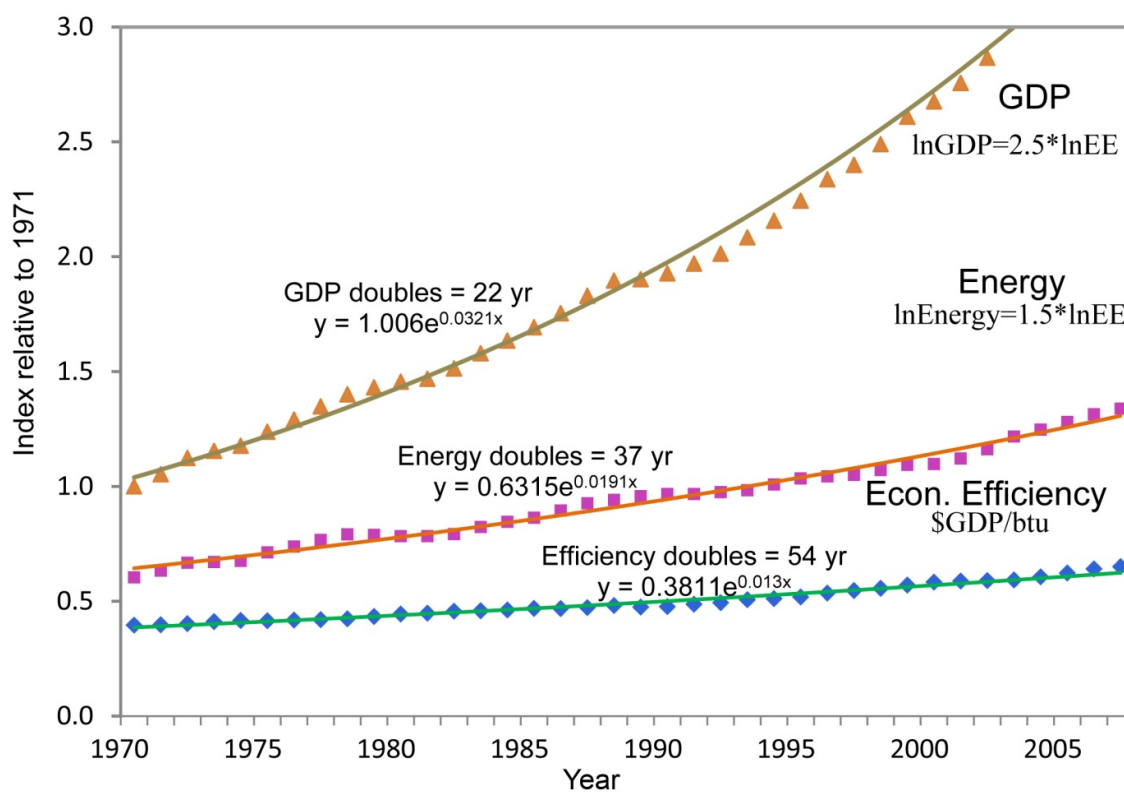

Figure A2. Relative historic economic growth trends for GDP, Energy use and Economic Efficiency (\$/Wh) for purchased energy use [36]: Curves each indexed to 1971 GDP, with Energy use and Economic Efficiency then scaled by the ratio of their own growth rate to GDP growth rate. The relationship is $\ln\text{GDP} = \ln\text{Energy} + \ln\text{EE}$. Each curve is shown with an exponential fit with indicated doubling rate (Table 4 in [29]).



© 2011 by the authors; licensee MDPI, Basel, Switzerland. This article is an open access article distributed under the terms and conditions of the Creative Commons Attribution license (<http://creativecommons.org/licenses/by/3.0/>).

Article

Relating Financial and Energy Return on Investment

Carey W. King ^{1,*} and Charles A.S. Hall ²

¹ Center for International Energy and Environmental Policy, Jackson School of Geosciences, The University of Texas at Austin, 1 University Station, C9000, Austin, TX 78712, USA

² Programs in Environmental and Forest Biology, Environmental Science and Environmental Studies, State University of New York–College of Environmental Science and Forestry, Syracuse, NY 13210, USA; E-Mail: chall@esf.edu

* Author to whom correspondence should be addressed; E-Mail: careyking@mail.utexas.edu, Tel.: +1-512-471-5468.

Received: 8 February 2011; in revised form: 18 July 2011 / Accepted: 18 August 2011 /

Published: 11 October 2011

Abstract: For many reasons, including environmental impacts and the peaking and depletion of the highest grades of fossil energy, it is very important to have sound methods for the evaluation of energy technologies and the profitability of the businesses that utilize them. In this paper we derive relations among the biophysical characteristic of an energy resource in relation to the businesses and technologies that exploit them. These relations include the energy return on energy investment (EROI), the price of energy, and the profit of an energy business. Our analyses show that EROI and the price of energy are inherently inversely related such that as EROI decreases for depleting fossil fuel production, the corresponding energy prices increase dramatically. Using energy and financial data for the oil and gas production sector, we demonstrate that the equations sufficiently describe the fundamental trends between profit, price, and EROI. For example, in 2002 an EROI of 11:1 for US oil and gas translates to an oil price of 24 \$2005/barrel at a typical profit of 10%. This work sets the stage for proper EROI and price comparisons of individual fossil and renewable energy businesses as well as the electricity sector as a whole. Additionally, it presents a framework for incorporating EROI into larger economic systems models.

Keywords: EROI; return on investment; net energy; energy business; profit

1. Introduction

What is the minimum energy return on energy invested (EROI) that a modern industrial society must have for its energy system for that society to survive? To allow a profitable business venture? To afford arts, culture, education, medical care? To grow? Is it the same as the minimum EROI that a fuel must have to make a meaningful contribution to a society's material well-being? And what is the price of energy at this minimum EROI? There has been remarkably little discussion of this issue in the last 50 years outside of our own previous papers on the subject [1] even though we believe that it might be a defining aspect of future societies. Many earlier authors, including anthropologist Leslie White [2], economist Kenneth Boulding [3], anthropologist/historian Joseph Tainter [4,5] and ecologist Howard Odum [6] have argued that for a society to have cultural, economic and educational richness it must have a large quantity of energy resources with sufficient net energy. That is to say complex societies need a high EROI built on a large primary energy base.

With the exception of the considerable discussion around whether corn-based ethanol is or is not a net energy yielder [7,8] there has been almost no contemporary discussion of the implications of changing EROI on industrial society. The lack of such studies seems curious as this will be a very important issue relating to our future, during which the mutual impacts of peak oil and declining EROI of fossil resources are likely to cause a very large overall decline in the net energy delivered to our industrial society. Furthermore, a lack of consistent and sufficient net energy comparisons among fossil fuels and renewable energy alternatives for liquid fuels and electricity prevents adequate understanding of our investments in alternative energy systems with different EROIs. This issue is exacerbated by the failure of the public at large, the media and even most of the scientific community to be able to see through the generally self-serving and shallowly analyzed pronouncements of various energy possibilities. For example, a wind farm and coal-fired power plant with equal EROI are not fully equal in terms of providing the same energy service until the wind farm is as dispatchable (on minute to daily time scales) as the coal plant. Additionally, a coal-fired power plant has more long-term uncertainty in EROI than a wind farm based upon the mining energy requirements. The wind farm long term certainty stems from the fact that the average wind speed will occur over the decadal life span of the turbines. Of course, environmental impacts and externalities (e.g., equivalent CO₂ emissions) also could play a major role, but we restrict the scope of this paper to the pure energy economic implications of changing EROI. If in the future environmental externalities are priced into the economic market, our general methodology would still hold, but will need to be updated.

There may already be very large impacts of declining EROI on our society, although this is difficult to untangle from peak oil impacts and the recession that started in 2007, which was at least partly due to increasing oil price [9,10]. Whatever the particular causative chain of events, a few recent trends appear: both oil and energy use have been declining in the United States, including a drop in total energy consumption from 99.3 quads in 2008 to 94.6 quads in 2009 [11,12]; global peak crude oil production-or something like it has occurred or is occurring (see Figure 1) [13,14] with many agreeing that world crude oil production peaked in 2005; the US's "Great Recession" officially lasted from December 2007 until June 2009 [15]; many financial entities are still in very rough shape after the financial crises that began in 2008, including many banks and Wall Street firms; the average inflation-corrected value of stocks has ceased increasing over the last decade [10], bonds have

outperformed stocks over the last decade; and over the last two years most States and many municipalities have been forced to cut social and civil services to balance budgets. To what degree all of these effects are related to EROI is speculative, but worth speculating on.

Figure 1. The world total oil supply has leveled between 83.1–85.5 MBBL/d from 2004 to 2009 [13,14]. Production in the first 10 months of 2010 show it at slightly above the 2008 peak (~86.1 MMBBL/D), but world production of “crude oil + lease condensate” peaked at 73.7 MMBBL/D in 2005.

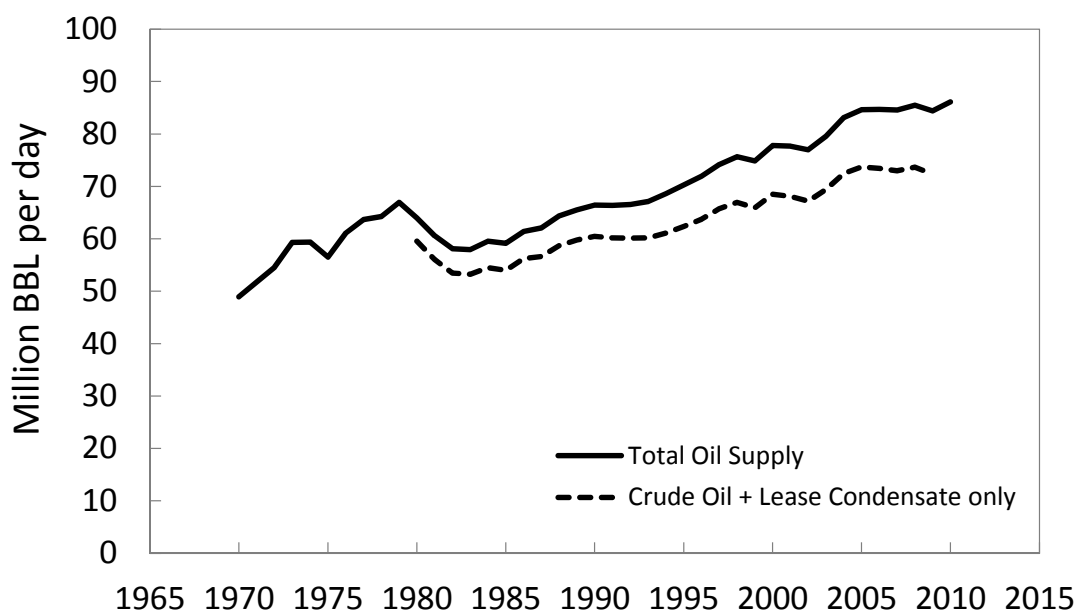

The most explicit analysis of the EROI needed by society that we are aware of is Hall, Balogh and Murphy (2009) [1], who made calculations on the energy required to refine, ship and transport fuels to their use destination, as well as to develop and maintain the infrastructure necessary to use them. They used direct and indirect energy costs ($EROI_{stand}$) as recommended by Murphy and Hall in this special issue [16]. They concluded that the minimum EROI required for transportation fuels appeared to be in the vicinity of 3:1. That is to say, for every unit of energy consumed at the point of use, as in a car, at least three units of energy must be produced in order to (1) extract, refine and distribute the final fuel to the point of use in the form required by consumers, (2) manufacture the end-use machinery, and (3) build and maintain the infrastructure (*i.e.*, roads and bridges) within which the fuel system operates. If the EROI was less than 3:1, then the fuel might be extracted but it could not be used to drive a transportation system. But this appears not to be the whole story.

No energy-producing entity (EPE, *i.e.*, firm, National Oil Company, *etc.*) can produce a fuel over time (without subsidy) if it does not make a monetary profit, and it is not an EPE if it has a long-run $EROI < 1:1$. In other words, an EPE has the economic profit constraint of any other firm, so that it must sell its product (energy) for more than the monetary cost of the energy (direct and indirect) inputs required to produce it—*plus* it has to pay for the labor, profits and so on for the entire supply chain

leading to the energy containing products it uses. These cost factors are normally accounted for in cash flow analyses of energy production businesses and processes, but are not always accounted for in EROI analyses. If we have a value for EROI that correlates to the same monetary costs of the full supply chain for energy production, then we should be able to estimate the cost of energy.

But the financial constraints are even stricter. For a firm to make a profit, it has to have some value of positive EROI because the energy flows associated with its costs (roughly 14–20 MJ per \$2005 for the US oil and gas extraction industry, including direct and indirect costs [17,18]) are much less than the energy associated with a dollar's worth of its product. For example, if oil sells in 2005 for \$61 per barrel (BBL) (containing 6,100 MJ), then each dollar gained by the oil company is associated with 100 MJ that has come out of the ground. If the EROI for the oil was 2:1, then the firm could not make a profit because for each 20 MJ invested in the business, at a cost of \$1, only 40 MJ are output can be sold at a value of \$0.40 [19]. Hence, at \$61/BBL to make a profit a firm needs to have an EROI of at least 5:1, or alternatively if the price of oil were higher the firm could make a profit at a lower EROI. The conundrum is that as the price of oil goes up so does, historically, the price of everything else, at least eventually, including those things required to produce the oil. For example, cost for drilling US oil wells increased 270% from \$150/ft in 2000 to \$590/ft in 2007 (in \$2007) [20] as the US first purchase price of oil increased 110% from \$30/BBL to \$63/BBL (in \$2005) during the same time frame [21]. Over time the minimum EROI for a profit can be used as an investment guide for the company.

Our objective in this paper is to relate the EROI of energy produced by an EPE to the cost of energy and monetary return on investment (MROI) of that same firm, both theoretically and compared to historical empirical information for US energy sectors. This is not merely an academic exercise. As the EROI of our major fuels continues to decline [18,22] a major extension of this analysis is that economic profitability could stop long before EROI reaches 1:1. Our hypothesis for the analysis of this paper is that the biophysical characteristics of producing available energy, namely the EROI of the energy production process, dictate a limit on the price and profit margin for a firm to engage in energy production and exploitation. At least one other paper has addressed the important issue of relating EROI to price of energy, where the authors applied a statistical analysis of various fitted curves that are based upon a similar structure as we present [23]. Here, rather than optimize for a statistical correlation, we formulate an underlying basis for the relationship between price and EROI such that there is a physical basis for price and a framework for projecting future trends.

2. Methods

Our basic method was to develop a mathematical expression for the relation of the biophysical characteristic, EROI, of an exploitable energy resource to the economic conditions that makes the exploitation possible. We derive an equation that describes the general trends of certain parameters of interest, namely the EROI, the monetary return on investment (MROI), and the unit price of produced energy, p (e.g., \$/BBL, \$/MWh, *etc.*) sold in the market. At $MROI = 1$, the predicted price equals the producer price, or cost of production.

The definition for EROI is as shown in (1). EROI is the energy output (E_{out}) from an energy production system divided by the required energy inputs (E_{in}) to the system. Most EROI analysts

calculate (1) without discounting future energy production *versus* energy produced and consumed today, and for simplicity, our analysis also assumes simple energy and cash flow accounting (*i.e.*, we do not discount energy or money) [24].

$$EROI = \frac{E_{out}}{E_{in}} \quad (1)$$

Most analyses also imply that the relation for investments today are reflecting production today, whereas today's production is partly from yesterday's capital investments and today's capital investments are partly for tomorrow's production. The data from [18] used in this paper indicate that the ratio of indirect E_{in} /direct E_{in} for US oil and gas has varied from less than 0.3 to over 2 in the years in which high oil prices induced large increases in exploration and drilling (see Figure 2).

Figure 2. The capital intensity (ratio of indirect E_{in} over direct E_{in}) of the US oil and gas industry has increased over time with large ratios represented by times of high drilling activity in 1982 and 2007 (data from [18] assuming that a nominal 14 MJ was consumed for each real 2005 dollar invested for indirect E_{in}).

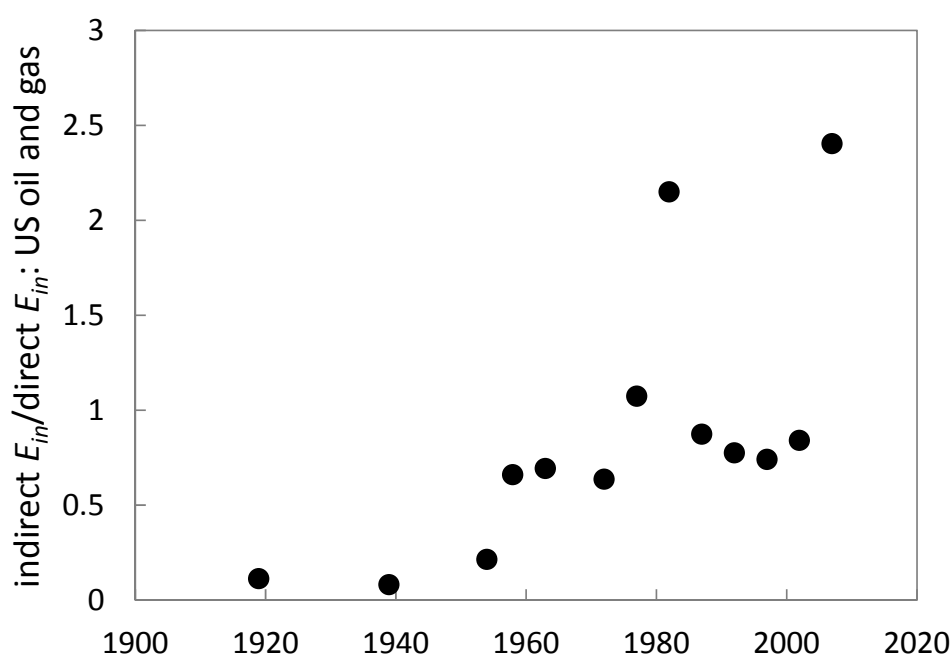

We now deconstruct (1) into a form used to calculate results for this paper. However, for previous descriptions of the general framework for characterizing how to include different inputs and outputs in (1), see [25-29]. Note that both the numerator and denominator of (1) can be composed of multiple factors: M forms of energy outputs and N forms of energy inputs. For example, an analysis of a drilling operation producing oil, natural gas, and natural gas liquids must count the energy content of all three (e.g., $M = 3$) resources to calculate E_{out} . The same premise holds for calculating E_{in} . Relations for the energy outputs and inputs of an energy production system are shown in (2) and (3) as a function

of energy intensity, e_i , of production (or consumption), multiplied by the number of units of production (or consumption). Here, we assume e_i is expressed in units of energy divided by any other unit whether that by a physical quantity (e.g., tonnes), money (e.g., dollars), or otherwise. In (2), M is the number of output energy products, and m_i represents the unit production of the i^{th} energy product. In (3), N is the number of input products that have direct or indirect embodied energy, and n_i represents the unit consumption of the i^{th} input. Example units of energy production are barrels (BBLs) of oil, megawatt-hours (MWh) of electricity, thousand cubic feet (MCF) of natural gas, *etc.* An example calculation is E_{out} for oil production where the energy content of a barrel (BBL) of oil is approximately $e = 6.1$ GJ/BBL, and if $m = 10$ BBLs of oil are produced, then $E_{out} = 61$ GJ. For Equation (3), the i^{th} unit input can describe direct energy (e.g., a BBL of oil) or indirect energy (e.g., energy embodied in a ton of steel, hour of labor, *etc.*). See [25] and [30] for a full discussion of how to consider different energy inputs and outputs, including using energy quality factors, when calculating E_{in} and E_{out} .

$$E_{out} = \sum_{i=1}^M m_i e_i \quad (2)$$

$$E_{in} = \text{direct energy} + \text{indirect energy} = \sum_{i=1}^N n_i e_i \quad (3)$$

Equation (3) should include both direct and indirect energy inputs and represents the common methodology for performing process-based and input-output based life cycle assessments (LCAs) [31]. Hence with proper data we can assess what part of the expenditure dollar went for direct energy and what part for the indirect energy that is responsible for the different energy/monetary ratios of inputs and products. For example, in an oil production system, the direct E_{in} calculated in (3) can be a summation of electricity (or better the fuel consumed during electricity generation) for running trailers, pumps, compressors, and computer equipment as well as diesel fuel consumed for operating trucks, pumps, and the drilling rig. However, it is insufficient to include only the direct energy inputs to capture all of the energy necessary for the full operation of the energy production system. EROI researchers additionally include measures for indirect energy inputs to consider energy inputs from operations outside of the energy producing operation itself. For example, oil derricks have towers made from steel, and one company may install and operate the drill, but another made the steel tower. Because the energy inputs required to make the steel are not performed on the site of the oil well, they are considered indirect energy and can be included in the analysis by knowing the energy required per unit or dollar of production (e.g., energy intensity e) and following (3). For example, in 2004 the average mass energy intensity of steel was $e_{st} = 20,000$ MJ/tonne [32]. Thus, to include the indirect energy inputs from steel in (3), n is number of tonnes of steel and $e_i = e_{st} = 20,000$ MJ/tonne. When physical units are not available analysts must use dollars of steel (e.g., n in units of \$) and monetary energy intensity (e.g., e in units of MJ/\$) for such dollars spent.

It is possible to estimate indirect E_{in} using nominal data from input-output (I-O) analyses of the entire economy. Examples of such analyses are those by Bullard, Herendeen, and Hannon in the 1970s [33], Costanza and Herendeen in the 1980s [34,35], and the somewhat less comprehensive or detailed but more recent Economic Input-Output LCA analyses by Carnegie Mellon [36]. These I-O analyses blend national-level economic and energy consumption data to analyze the impacts of complete economic sectors rather than individual technologies or processes. In using I-O analyses,

the most aggregated value of e_i that characterizes energy consumption and economic cost is the economy-wide energy consumed for every one dollar of investment by the energy sector of interest (e.g., oil and gas extraction sector). If monetary e_i (e.g., in units of MJ/\$) is not available for the sector or project of interest via an I-O analysis, then the overall monetary energy intensity, e , of the economy (e.g., state, country, world) can be used as the best proxy. However, investments of energy industries have higher than average energy intensity. Equation (4) represents energy inputs as a function of money invested and energy intensity of the investment, $e_{investment}$, in units of energy per money (e.g., MJ/\$).

$$E_{in} = \$_{investment} \cdot e_{investment} \quad (4)$$

Alternatively, one can calculate $e_{investment}$ using Equation (3) to calculate all energy inputs and dividing them by all money spent to purchase those inputs. For reconstructing the value of $e_{investment}$ without I-O analyses, we can use (5).

$$e_{investment} = \frac{E_{in}}{\$_{investment}} = \frac{\sum_{i=1}^N n_i e_i}{\sum_{i=1}^N n_i p_i} \quad (5)$$

To relate EROI to the $e_{investment}$, we substitute (2) and (4) into (1) to obtain (6), a working definition of EROI.

$$EROI = \frac{E_{out}}{E_{in}} = \frac{\sum_{i=1}^M m_i e_i}{\$_{investment} e_{investment}} \quad (6)$$

Thus, the higher the $e_{investment}$ for energy business operations, the lower the EROI. Note that in the case of oil production, as the oil resources left to exploit get deeper, heavier or from more inhospitable areas, it is important to understand not only how much more direct energy (e.g., diesel fuel and electricity) is required for drilling deeper and pumping up the oil but also how much indirect energy (e.g., infrastructure, engineering, and planning) is required. If an oil resource primarily requires direct energy, this raises $e_{investment}$ because fuels have high ratios of energy/\$ by definition (e.g., if a fuel was sold for an energy/\$ ratio below that of the average of the economy, then the firm selling the energy would be a net energy consumer and not a net energy producer). Therefore, as $e_{investment}$ increases, this produces a further feedback on decreasing the EROI of the resource. Additionally, the steel, aluminum, and other heavy manufacturing materials that are required for new drilling and construction of power plants are also characterized by $e_{investment}$ higher than economy average (but lower than for fuels), again creating a feedback for lowering the EROI per Equation (6).

We next create (7), where m_i are in physical units of produced energy and e_i are in units of as an analog to (6) to enable a relation between simple monetary return on investment, MROI and EROI.

$$MROI = \frac{\$_{out}}{\$_{investment}} = \frac{\sum_{i=1}^M m_i p_i}{\$_{investment}} \quad (7)$$

From (7), we solve for the total money invested as:

$$\$_{investment} = \frac{\sum_{i=1}^M m_i p_i}{MROI} \quad (8)$$

Substituting (8) and (5) into (6) and we obtain an equation that shows EROI as a function of important economic factors:

$$EROI = \frac{\sum_{i=1}^M m_i e_i}{\sum_{i=1}^M m_i p_i} \cdot \frac{MROI}{e_{investment}} \quad (9a)$$

$$= \frac{\sum_{i=1}^M m_i e_i}{\sum_{i=1}^M m_i p_i} \cdot \frac{\sum_{i=1}^N n_i p_i}{\sum_{i=1}^N n_i e_i} \cdot MROI \quad (9b)$$

We use Equation (9b) to explicitly solve EROI as a function of the individual components of $e_{investment}$. Assuming for simplicity that there is only one type of energy production (e.g., $M = 1$), we easily solve (9) for one output variable of interest as a function given values for all other variables. For example, useful relations are (10) and (11). Equation (10) specifies the requisite sales price, p , of a unit of energy production (e.g., \$/BBL of oil) as a function of EROI and MROI, and (11) specifies the monetary return on investment as a function of EROI. In the following results section, we use (10) and (11) to demonstrate the current methodology.

$$p_i = \frac{MROI}{EROI} \cdot \frac{e_i}{e_{investment}} \quad (10)$$

$$MROI = \frac{EROI \cdot p_i e_{investment}}{e_i} \quad (11)$$

The benefit of the relations described by (4–11) is that we have derived an equation with both EROI and MROI explicitly stated together. Previous research either defines EROI without relation to monetary profits, or derives EROI from economic data of a specific year, but still without a closed form function relating EROI and MROI. To properly use (10) and (11), one must make sure that the parameters all correspond to the same time frame and system boundaries or point in the supply chain of an energy production technology, business, or system. For example, if analyzing the price of oil from a specific field, then the inputs to (10) and (11) must be the expected MROI, EROI, and $e_{investment}$ of production for that field only. If one is interested in the average price of oil from the entire United States oil and gas sector, then the inputs to (10) and (11) must relate to the entire sector. Thus, the structure of (4–11) should allow researchers to do both top-down economic sector analyses as well as bottom-up technology-specific analyses to analyze the entire energy supply chain. By reconstructing the top-down results from bottom-up techniques, better future energy projections may be possible. However, in practice, bottom-up process LCAs are more easily performed using E_{in} as defined in (3) because values for process-specific $e_{investment}$ are generally not available.

In (9–11) the various factors are not independent of each other. Ideally, data and calculations for EROI can be made independent of economic inputs, and this is most plausible when considering direct energy inputs only in (3). In considering indirect energy inputs, however, (e.g., that energy required for producing steel used in oil well casing), often times only monetary data are available (e.g., money spent for purchasing steel), requiring a blend of available economic and energy intensity data (e.g., an aggregate value of e in units such as MJ/\$) to estimate energy inputs. Additionally, when considering sector level analysis, economic data are generally all that are available. Thus, it is important to understand that EROI is not an independent function of $e_{investment}$ as it appears to be considered in (9–11). For example, oil as refined diesel is a major input into drilling for oil (e.g., as fuel for drilling rigs). Thus, if the biophysical descriptor (*i.e.*, EROI) decreases because of the need to consume more diesel in drilling to deeper oil resources, other input products (e.g. steel) can become more expensive in both money and energy if they depend upon oil for production and shipping. That is to say, as the price of oil gets higher, it can have a feedback making it more expensive to produce more oil. Additionally, EROI is inversely proportional to the energy intensity of investment in energy production while at the same time being proportional to the energy output per unit of production (e.g., BBLs of oil production at 6,100 MJ/BBL). By using (9), we can account for a situation in which the EPE pays a price for an energy resource input that is different than the price for which the EPE sells the same energy resource as an output. By breaking $e_{investment}$ into a weighted sum of many investments as in (5) and (9), we can gain insight into the coupling of inputs from each sector or fuel (direct or indirect) upon EROI, and ultimately the price of energy required to make a given financial return. In practice such assessments often are very difficult because the energy companies (especially national oil companies) keep much of this information to themselves.

Also, Equations (10) and (11) show that as energy gets more expensive, partially characterized by decreasing energy intensity (e.g., energy per dollar) of investment in energy production, $e_{investment}$, then energy price increases at constant EROI. The counter-intuitive result from (10) is that as the energy intensity of investing in energy production increases, the price of energy necessary to make a constant profit decreases. The reason is that higher energy intensity *purchases* represent cheap energy inputs and the ability to make higher monetary returns for a given EROI.

3. Results

To gain insight into our methods, we use Equation (10) to estimate results under representative historic economic conditions. We first use the example of US oil production and later repeat the analysis for natural gas and coal production. Our results indicate that Equations (9–11) act as broad but valid representations of the relations between EROI, MROI, and the stated technoeconomic factors.

3.1. Calculating Oil Price as a Function of EROI and Financial Parameters

Assuming for the moment that barrels of oil are the only energy output unit from oil and gas operations, we use (10) to plot estimated oil price for a range of expected inputs. Equation (10) has four inputs on the right hand side, and we must choose sources of data for these data inputs. Because there are no definitive values to input into Equation (10) for calculating oil price, we calculate price as

a function of EROI using a range of reasonable inputs. We estimate input values for estimating the price of oil via Equation (10) as follows and plot the results in Figure 2:

- (1) e_{oil} : We assume that the energy content for a barrel of oil is 6,100 MJ/BBL.
- (2) $e_{investment}$: Per Equation (9b) energy inputs are a combination of direct and indirect energy. By summing all energy inputs and dividing by all monetary inputs we obtain the estimate for total $e_{investment}$. For estimating the total $e_{investment}$ for oil and natural gas we use the direct and indirect energy input values from Guilford *et al.* (2011) of this special issue of *Sustainability* [18]. Reliable fuel price data (for cost of direct energy from natural gas, fuel oil, gasoline, and electricity) exist from the EIA after 1949, and we only calculate total $e_{investment}$ for dates after 1949. Guilford *et al.* (2011) assume a nominal estimate of $e_{investment} = 14$ MJ/\$2005 for cost of capital, or indirect energy inputs [18]. The Appendix shows the values for $e_{investment}$ for each year of data in [18].
- (3) $MROI$: We use estimates of monetary return on investment, MROI, from two sources for comparison and sensitivity analysis: the EIO-LCA oil and gas extraction industry (NAICS 211) and a document of the American Petroleum Institute (API) [37]. The API quotes a 7% annual profit assumption for the entire oil and gas industry and is likely an underestimate, but represents a typical long term value. The EIO-LCA model specifies 40% and 51% annual profits for 1997 and 2002, respectively, for the targeted NAICS 211 oil and gas extraction sector producer price models [36,38]. Thus, we plot Equation (10) for both $MROI = 1.1$ and $MROI = 1.5$ to signify the expected range of profits.
- (4) $EROI$: We plot estimates of EROI for US oil and natural gas from two sources alongside our results plotted using Equation (10) (see references below for discussions of how EROI varies over time):
 - i. The first EROI estimates are those of the US oil and gas industry from Cleveland (2005) reported for every fifth year from 1954 to 1997 [26], and
 - ii. the second EROI estimates are those of the US oil and gas industry from Guilford *et al.* (2011) [18] of this special EROI issue for every fifth year from 1919 to 2007.

The most difficult factors to obtain accurately in (10) are the EROI and MROI for any given time period, and thus the methods of this paper should not be expected to predict short term price fluctuations, but rather they contribute insight into long term trends. For a given EROI, however, it is easy to see the price effect of the energetic cost of production and taking higher profits. In Figure 3 we plot the general trends of the price of a BBL (\$2005/BBL) [21] of oil *versus* the EROI and expected range of MROI for the oil and gas industry. In recent history, EROI for oil and gas has been between 10–30 [22,26,28,39]. While this range appears to be large, it translates to an oil price of less than \$70/BBL at annual profit ratios less than $MROI = 1.5$. This price has been exceeded regularly only in the last few years, which might reflect the apparently rapid decline in EROI that we have seen recently (see many papers in this special issue of *Sustainability*).

In Figure 3 the modeled range of oil price and EROI brackets most of the data points composed of literature EROI values and historical oil prices (only the average annual prices are plotted). Each solid and dashed line in Figure 3 represents the Equation (10) estimate and assumes a constant value for both $e_{investment}$ and MROI. These data points confirm the general inverse trend of price relative to

EROI. If EROI becomes less than 10, as may soon be the case for average US oil, the requisite oil price increases dramatically and at a nonlinear increasing rate. For example, consider the EROI of Canadian oil sands extraction that is now a significant source of petroleum and influential in setting the worldwide marginal oil price. Assume that each barrel of bitumen brought to the surface using steam assisted gravity drainage (SAGD) technique is 6,100 GJ/BBL, the same as crude oil (an overestimate). Additionally, assume a typical need for 2–3 BBL of steam per BBL of extracted bitumen and natural gas for creating steam at 0.45 Mcf/BBL of steam [40]. Using the natural gas as the first energy input (clearly not the only energy input) the EROI of oil sands is no larger than 4–6:1 nearly an order of magnitude lower than the average oil and natural gas EROI of the past. From Figure 3, we see that oil production with an EROI of 4–6 and annual profits between 10% and 50% requires a price of 40–120 \$2005/BBL. Realistic EROI for oil sands near 3–4 indicate oil prices of 50–160 \$2005/BBL: with the mid-range being higher than the economy was able to support running up to the recession started in late 2007 [15]. A review of oil shale in this special issue of *Sustainability* indicates that oil shale EROI is between 1 and 2.5 with the major energy input being direct energy for heating the shale [41]. Thus, our analysis suggests oil prices (at the mine) of \$80/BBL–\$200/BBL (in \$2005) at 10% annual profit assuming the highest value of $e_{investment} = 33$ from Guilford *et al.* (2011; red solid line in Figure 3) [18].

Figure 3. The price of a barrel of oil necessary for a firm to make a target profit is heavily dependent upon the EROI of oil production. As the EROI of production gets lower than approximately 10, the price of oil must increase dramatically for realistic profit ratios below $MROI = 1.5$. Each solid and dashed line represents the Equation (10) estimate and assumes a constant value for both $e_{investment}$ and $MROI$. The EROI O&G–Guilford (2011) values are from [18], EROI O&G–Cleveland (2005) values are from [26], and oil prices are from the Energy Information Administration [21].

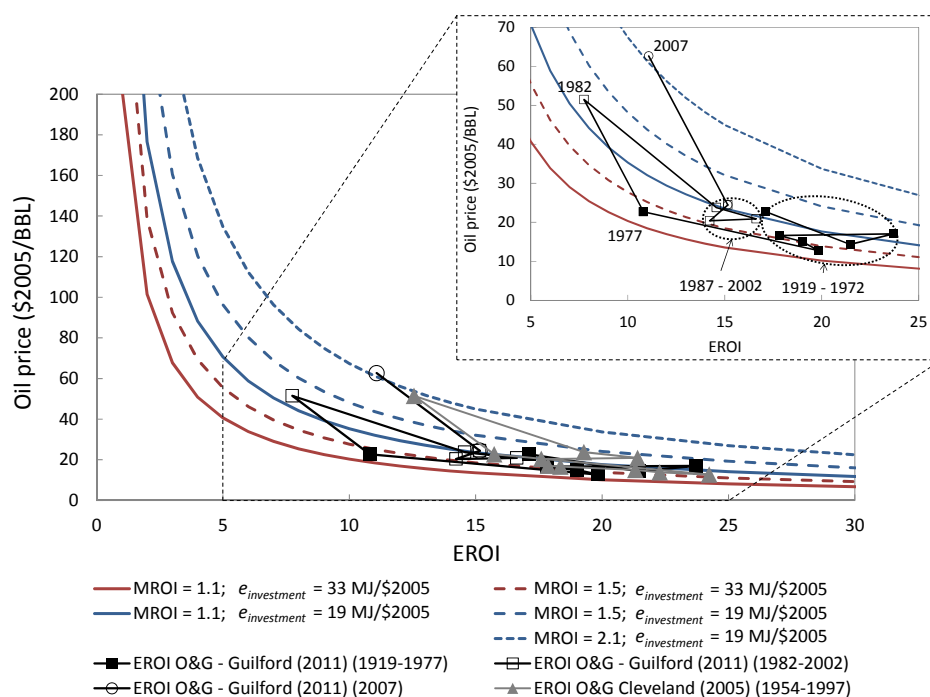

In looking further at the plotted EROI and price points in Figure 3 we find an interesting pattern. Recall that the EROI values can only be calculated every fifth year due to data availability (see references for description). First, the EROI values from Cleveland (2005) predict higher prices at the same EROI [26]. Also, the only two outliers from the data points associated with oil prices less than 25 \$2005/BBL are those for 1982 and 2007. The slopes are almost identical for the relative increase in price with decreasing EROI for both the price increase from 22.7 \$2005/BBL in 1977 to 51.5 \$2005/BBL in 1982 and also the price increase from 24 \$2005/BBL in 2002 to 63 \$2005/BBL in 2007. For the change from 1977 to 1982 the slopes are -9.1 and -9.4 (units of \$2005 per EROI, or \$2005) for Cleveland (2005) [26] and Guilford *et al.* (2011) [18], respectively. The slope from 2002 to 2007 is -8.3 .

Each of the five lines plotted in Figure 3 using Equations (9) and (10) assumes a constant $e_{investment}$ and MROI. The solid and dashed red lines (lower left lines) use $e_{investment} = 33$ MJ/\$2005 which we calculated as typical for all years after 1958 except for 1982 and 2007. For both 1982 and 2007 our calculated $e_{investment} = 19$ MJ/\$2005. See the Appendix for details on calculating $e_{investment}$. Assuming 10%–50% annual profit sufficiently describes the actual prices except for 1982 (Cleveland, 2005) [26] and 2007 (Guilford *et al.*, 2011) [18]. During the time spans of 1979–1982 and 2005–2007 real oil prices rose more than \$7/yr – too fast for oil companies to bring new production online to benefit from the prices. Thus, their existing production that planned on making a profit at lower prices made considerably larger profits (higher MROI than normal) during these years of abnormally high oil prices. Thus, Equations (10) and (11) as exhibited in Figure 3 show that oil prices in 1982 and 2007 allowed for significantly higher profits.

3.2. Calculating Natural Gas Price as a Function of EROI and Financial Parameters

We repeated the calculations of Section 3.1 using natural gas as the output instead of oil (see Figure 4). We use $e_{NG} = 1,085$ MJ/Mcf where Mcf is one thousand cubic feet of natural gas, the common US unit to describe natural gas transactions. We plot natural gas price (\$2005/Mcf) [21] *versus* the same EROI for oil and gas from Cleveland (2005) [26] and Guilford *et al.* (2011) [18], and our relation again predicts the price trends relative to measured EROI. One important feature to notice in Figure 4 is the group of data points that lie below the bounds of the prediction Equations (10) and (11). These points correspond to prices and EROI for the year 1977 and earlier—before the Natural Gas Policy Act of 1978 ended regulation of wellhead natural gas prices. After 1977, natural gas producer prices rose to incentivize new production and more accurately reflect costs.

However, our results show the general ability of the basic formulation of the present work to relate EPE monetary and energy profits over long term trends. The formulation also shows that $EROI < 10$ generally relates to natural gas prices greater than 6 \$/Mcf. Thus, it is very important to understand the EROI of new natural gas resources, such as from shales, because these are more decoupled from oil prices in accessing resources that do not coproduce natural gas with oil. Knowing the viable range of EROI for delivered, not wellhead, natural gas should help us gain understanding with regard to future volatility in natural gas prices.

Figure 4. The price of a thousand cubic feet of natural gas necessary for a firm to make a target return on investment is heavily dependent upon the EROI of natural gas production. Each solid and dashed line represents the Equation (10) estimate and assumes a constant value for $e_{investment}$ and MROI. The plotted values EROI O&G – Guilford (2011) are from [18], EROI O&G – Cleveland (2005) from [26], and natural gas prices are in units of \$2005/Mcf from the Energy Information Administration [21].

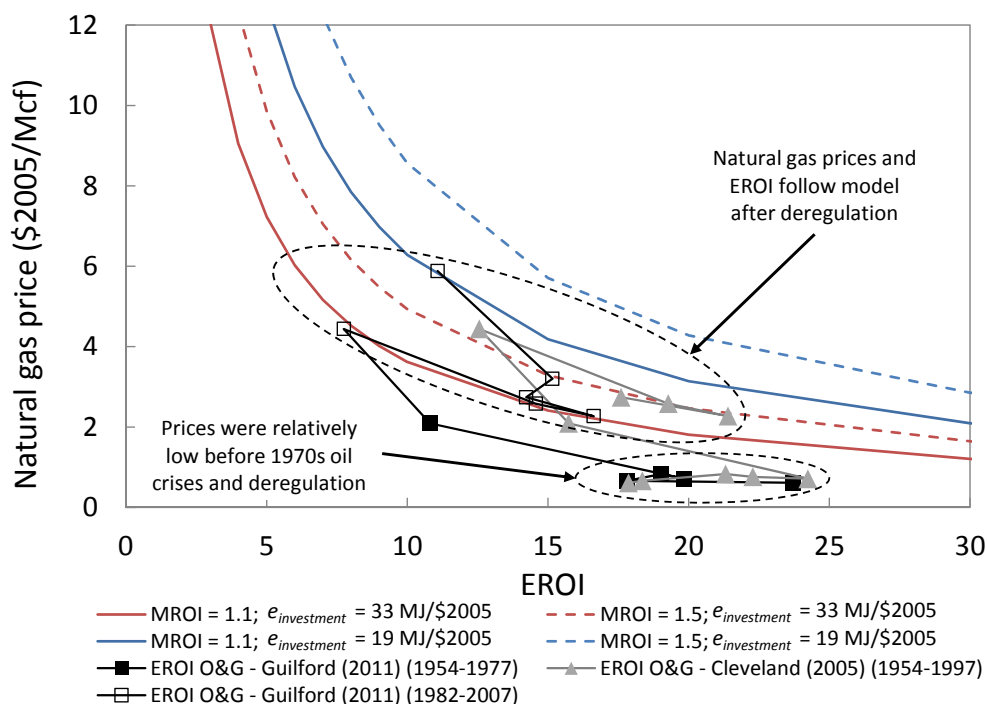

3.3. Impact of Capital Intensive Energy Technology

There is an interesting and important trend to note from our relation between price and EROI. This trend relates to the energy intensity of the investment, $e_{investment}$, for energy generation. A capital intensive investment will have relatively little fuel consumption but relatively high material usage, or capital. We interpret high capital intensity of the investment as a low value of $e_{investment}$. For example, steel has direct embodied energy of approximately 20 GJ/tonne and at \$700/tonne represents an energy intensity of $e_{steel} = 28$ MJ/\$. On the other hand, a fuel intensive investment in the life cycle of energy production is represented by a high value of $e_{investment}$. For example, if natural gas were an input to an energy production life cycle at \$7/Mcf, a typical medium-range price, the energy intensity of that investment translates to $e_{NG} = 155$ MJ/\$. Thus, if $e_{investment}$ is weighted toward fuels, it will be relatively large. If $e_{investment}$ is weighted toward materials and capital, it will be relatively low.

As Equations (10) and (11) indicate, as the capital intensity of the energy technology investment increases, the price of energy sold must increase *even at the same EROI* (see Figure 5). In other words, if one technology can produce fuel at EROI = 10 and $e_{investment} = 10$ MJ/\$ and another technology can produce fuel at EROI = 10 and $e_{investment} = 15$ MJ/\$, then the fuel is cheaper from the latter technology. Philosophically this means that, at an equal EROI, energy production systems that are more dependent

on their own product (e.g., fuels) are cheapest. This concept has implications for renewable energy technologies that are relatively capital intensive in order to extract energy from the sun and wind yet have little to no fuel consumption during operational part of the life cycle. As seen in Figure 2, capital intensity also is important for understanding prices in the fossil fuel extraction industry. The oil and gas industry responded to high oil prices by increasing drilling rates in the early 1980s and late 2000s and this translated to higher material and human capital intensive investment periods (e.g., steel, concrete, overhead for oilfield service companies, *etc.*). Because the benefits of these capital investments occur for many years after initial the expenditure, it is important for future work to properly characterize the time lags of EROI and E_{out} relative to capital intensive energy investments. Future work should also explore the energy intensity, $e_{investment}$, of alternative fossil and renewable fuels to understand which price curve of Figure 5 is more relevant for each fuel (e.g., oil sands that are heavily reliant on natural gas, biofuels using both free solar energy and fossil fuel inputs, *etc.*).

Figure 5. When considering two energy production life cycles with the same EROI, the one with the higher energy intensity of investment $e_{investment}$ can be sold at a lower breakeven price or higher profit at the same price.

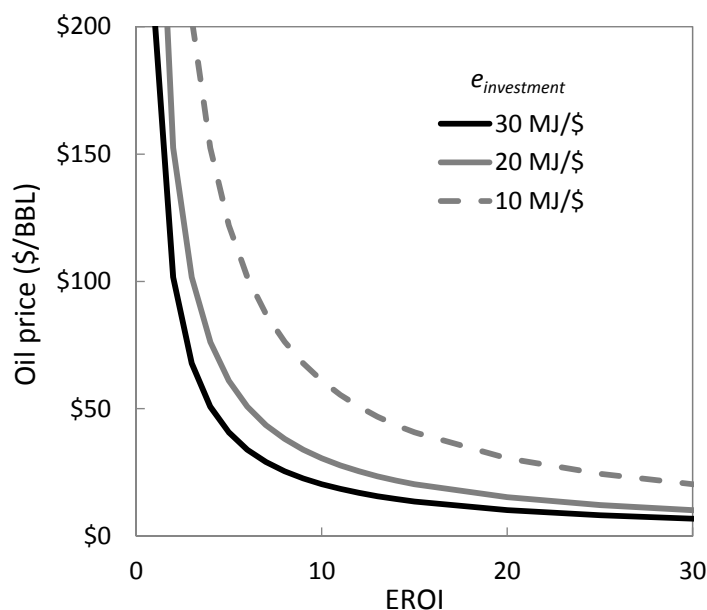

4. Conclusions

Our equations derived in this paper appear to predict rather well the basic relations among profits, prices, and EROI. This formulation, however, is not meant necessarily to predict short term prices, but rather characterize broad relations and the ways in which we believe that EROI drives large scale financial phenomenon and long-term energy investments. It is important to note that Equations (9–11) represent equilibrium conditions with no constraints on any required inputs. In reality there can be shortages in global oil supply or quickly increasing demand of infrastructure for oil and gas development (e.g., drilling rigs) that raise prices much faster (in time) than indicated by the theory of

this paper. Thus, the theory of this paper can be viewed as describing a lower bound on price as it relates to EROI.

The data used in Guilford *et al.* (2011) [18] and Cleveland (2005) [26] do represent some dynamics in supply and demand with regard to oil production. Because the underlying data from the US Census of Mineral Industries is reported only every five years, there are few conclusions we can make regarding the rate at which the underlying EROI changes on annual or monthly time scales. By the method and demonstrations developed in this paper we have confirmed our major hypothesis that the biophysical characteristic of EROI is a major factor that can dictate the profit margin and price necessary for a firm to engage in energy production. The relations in Equations (9)–(11) illustrate that lower EROI energy systems have less potential profitability for their businesses.

Over the long run, any energy producing entity must produce both a monetary and energetic profit. In the terminology of this paper, this statement means that $MROI > 1:1$ and $EROI > 1:1$. The question remains how much greater than 1:1 EROI must be. Considering that the past calculations of US EROI of oil and gas estimate it to never have been less than 7 [18,22,26], we can infer that there is some value of EROI between 10 and 1 that oil becomes prohibitively expensive. As seen in Equation (10), as EROI decreases, price increases. By developing theoretical minimum EROI values for fuels and electricity, as in one of the current author's previous work [1], we can translate those critical EROI values into a price range. Conversely, we can look to translate critical price thresholds as feedback to inform derivation of minimum EROI values.

If a business is characterized by $EROI < 1:1$, then by definition it is an energy *consuming* business no matter what the profit of the company. Thus, the monetary investments of an energy business must consume less energy than its products provide. In terms of our nomenclature, this means that $e_{investment} < e_{product}$ for an energy production business or sector. Considering the example in Section 3.1, the oil and gas extraction sector invested at $e_{investment} = 18.6$ MJ/\$2005 in 2007 to produce a product with energy intensity of $e_{oil} = (6,100 \text{ MJ/BBL}) / (63 \text{ \$2005/BBL}) = 97$ MJ/\$2005. Thus, based upon pure economic information, we can say that the oil and gas extraction sector multiplied the energy available to the economy by a factor of 5 (e.g. $97/18.6 = 5$) times. Equivalently in 2007, for the natural gas case study presented in Section 3.2 the energy available to the economy was increased by a factor of 10.

Historically, EROI has been many multiples higher than MROI, but our derived relation itself does not necessarily point to the limit of profitability. Theoretically, firms can charge higher prices in an attempt to command their desired profitability, but there is a price at which consumers are unwilling to pay or that they will cut back on consumption. Additionally, the marginal, or lowest EROI, energy supply often dictates the overall market price (e.g., oil) such that producers with high EROI supplies and resources sell at a large profit. We do show that because EROI is a ratio, as it drops lower and lower, the necessary price (at constant profit) increases quickly in a nonlinear manner. That is to say at a constant profit (e.g., $MROI = 1.5$) and $e_{investment} = 19$ MJ/\$2005, an EROI decrease from 5 to 2 (a 60% drop) has a much more dramatic absolute increase in price from \$96/BBL to \$240/BBL (a 150% increase), than a drop from 25 to 10 (a 60% drop) with an increase in price from \$19/BBL to \$48/BBL (also a 150% increase). Because EROI is a ratio, changes around low values are larger in the *absolute* sense than changes around high values. And because most consumers think linearly with budgets and incomes that do not quickly adjust to large absolute changes in oil price, small changes in EROI can quickly translate to budgetary difficulties for families, companies, and governments. This

phenomenon of decreasing net energy might explain a lot of our present economic difficulties [18,22]. Thus, low EROI directly translates to high price, and because EROI has a physical basis for its derivation, it is an important method for double checking and forecasting future energy prices and profitability of energy businesses.

In future work, the relations derived in this paper set the stage for proper EROI and price comparisons of individual fossil and renewable energy businesses as well as the electricity sector as a whole. For example, by including the EROI of individual energy technologies, including the energy inputs for investments in electricity storage, transmission, and distribution systems, we can use physical-based modeling to assist in forecasting a future energy transition to renewables. Additionally, the presented relations provide a framework for incorporating EROI into larger economic systems models that can explore the feedbacks between the EROI and prices of different energy supplies.

Acknowledgements

We would like to thank the Center for International Energy and Environmental Policy for providing the resources and time for the first author to work on this paper.

References and Notes

1. Hall, C.A.S.; Balogh, S.; Murphy, D.J.R. What is the minimum EROI that a sustainable society must have? *Energies* **2009**, *2*, 25-47.
2. White, L.A. Chapter 2: Energy and tools. In *The Evolution of Culture: The Development of Civilization to the Fall of Rome*; White, L.A., Ed.; McGraw-Hill: New York, NY, USA, 1959; pp. 33-49.
3. Boulding, K.E. The economics of the coming spaceship earth. In *Environmental Quality in a Growing Economy*; Jarrett, H., Ed.; Johns Hopkins University Press: Baltimore, MD, USA, 1966; pp. 3-14.
4. Tainter, J. *The Collapse of Complex Societies*; Cambridge University Press: Cambridge, UK, 1988.
5. Tainter, J.A.; Allen, T.F.H.; Little, A.; Hoekstra, T.W. Resource transitions and energy gain: Contexts of organization. *Conserv. Ecol.* **2003**, *7*, Article 4.
6. Odum, H.T. *Environmental Accounting: Energy and Environmental Decision Making*; John Wiley & Sons, Inc.: New York, NY, USA, 1996.
7. Farrell, A.E.; Plevin, R.J.; Turner, B.T.; Jones, A.D.; O'Hare, M.; Kammen, D.M. Ethanol can contribute to energy and environmental goals. *Science* **2006**, *311*, 506-508.
8. Pimentel, D.; Patzek, T.; Cecil, G. Ethanol production: Energy, economic, and environmental losses. In *Reviews of Environmental Contamination and Toxicology*; Springer: New York, NY, USA, 2007; Volume 189, pp. 25-41.
9. Hamilton, J. Causes and consequences of the oil shock of 2007-08. In *Brookings Papers on Economic Activity: Spring 2009*; Romer, D.H., Wolfers, J., Eds.; Brookings Institution Press: Washington, DC, USA, 2009.
10. Hall, C.A.S.; Groat, A. Energy price increases and the 2008 financial crash: A practice run for what's to come? *Corporate Exam.* **2010**, *37*, 19-26.

11. EIA. *Annual Energy Review 2007*; DOE/EIA-0384. U.S. Department of Energy: Washington, DC, USA, 2008.
12. EIA. *Annual Energy Review 2008*; DOE/EIA-0384. U.S. Department of Energy: Washington, DC, USA, June 2009.
13. EIA. International Petroleum data Annual Production. <http://tonto.eia.doe.gov/cfapps/ipdbproject/IEDIndex3.cfm?tid=5&pid=53&aid=1> (accessed on 9 August 2011).
14. EIA. *International Petroleum Monthly*; U.S. Department of Energy: Washington, DC, USA, 2009.
15. NBER. US Business Cycle Expansions and Contractions. National Bureau of Economic Research, Inc.: Cambridge, MA, USA. Available online: <http://www.nber.org/cycles/cyclesmain.html> (9 August 2011).
16. Murphy, D.J.R.; Hall, C.A.S.; Cleveland, C.J. Order from Chaos: A preliminary protocol for determining EROI for fuels. *Sustainability* **2011**, in press.
17. Gagnon, N.; Hall, C.A.S.; Brinker, L. A preliminary investigation of energy return on energy investment for global oil and gas production. *Energies* **2009**, *2*, 490-530.
18. Guilford, M.C.; Hall, C.A.S.; Cleveland, C.J. A new long term assessment of EROI for U.S. oil and gas production. *Sustainability* **2011**, in press.
19. $EROI \times (MJ/\$) \times \$\text{invested} \times [(\$/\text{BBL}) / (MJ/\text{BBL})] =$
 $(2)(20 \text{ MJ}/\$)(\$1\text{invested})(\$61/\text{BBL})/(6,100 \text{ MJ}/\text{BBL}) = \$0.40.$
20. API. *2007 Joint Association Survey on Drilling Costs*; American Petroleum Institute: Washington, DC, USA, 2008.
21. EIA. *Annual Energy Review 2009*; DOE/EIA-0384. U.S. Department of Energy: Washington, DC, USA, August 2010.
22. King, C.W. Energy intensity ratios as net energy measures of United States energy production and expenditures. *Environ. Res. Lett.* **2010**, *5*, 044006; doi:10.1088/1748-9326/5/4/044006.
23. Heun, M.K.; de Wit, M. Energy return on (energy) invested (EROI), oil prices, and energy transitions. *Energy Policy*, in press.
24. Discounting future E_{out} and E_{in} tends to lower the final EROI relative to a non-discounted result because E_{out} is generally assumed constant over system lifetime and E_{in} is “front-loaded” to varying degrees (e.g. technologies with no fuel costs such as wind and solar power are heavily “front-loaded”).
25. Mulder, K.; Hagens, N.J. Energy return on investment: Toward a consistent framework. *AMBIO* **2008**, *37*, 74-79.
26. Cleveland, C.J. Net energy from the extraction of oil and gas in the United States. *Energy* **2005**, *30*, 769-782.
27. Cleveland, C.J.; Costanza, R.; Hall, C.A.S.; Kaufmann, R.K. Energy and the U.S. economy: A biophysical perspective. *Science* **1984**, *225*, 890-897.
28. Hall, C.A.S.; Cleveland, C.J.; Kaufmann, R.K. *Energy and Resource Quality: The Ecology of the Economic Process*; Wiley: New York, NY, USA, 1986.

29. Hall, C.A.S.; Cleveland, C.J.; Mithell, B. Yield per effort as a function of time and effort for United States petroleum, uranium and coal. In *Energy and Ecological Modelling, Symposium of the International Society for Ecological Modeling*; Mitsch, W.J., Bosserman, R.W., Klopatek, J.M., Eds.; Elsevier Scientific: Louisville, KY, USA, 1981; Volume 1, pp. 715-724.
30. Murphy, D.J.R.; Hall, C.A.S.; Dale, M.; Cleveland, C. Order from chaos: A preliminary protocol for determining EROI for fuels. *Sustainability* in press.
31. Bullard, C.W.; Penner, P.S.; Pilati, D.A. Net energy analysis: Handbook for combining process and input-output analysis. *Resour. Energy* **1978**, *1*, 267-313.
32. IEA. *Tracking Industrial Energy Efficiency and CO₂ Emissions*; IEA: Paris, France, 2007.
33. Bullard, C.W.; Penner, P.S.; Pilati, D.A. Net energy analysis: Handbook for combining process and input-output analysis. *Resour. Energy* **1978**, *1*, 267-313.
34. Costanza, R. Embodied energy and economic valuation. *Science* **1980**, *210*, 1219-1224.
35. Costanza, R.; Herendeen, R.A. Embodied energy and economic value in the United States economy: 1963, 1967, and 1972. *Resour. Energy* **1984**, *6*, 129-163.
36. Carnegie Mellon University Green Design Institute Economic Input-Output Life Cycle Assessment (EIO-LCA) US 2002 (428) model. Available online: <http://www.eiolca.net/cgi-bin/dft/use.pl?newmatrix=US430CIDOC2002> (accessed 28 July 2010).
37. API. *Putting Earnings into Perspective: Facts for Addressing Energy Policy*; American Petroleum Institute: Washington, DC, USA, 2010. Available online: http://api-ec.api.org/statistics/earnings/upload/earnings_perspective.pdf (5 August 2010).
38. Carnegie Mellon University Green Design Institute Economic Input-Output Life Cycle Assessment (EIO-LCA) US 1997 (491) model. Available online: <http://www.eiolca.net/cgi-bin/dft/use.pl?newmatrix=US491IDOC1997> (accessed 5 August 2010).
39. Gately, M. The EROI of US offshore energy extraction: A net energy analysis of the Gulf of Mexico. *Ecol. Econ.* **2007**, *63*, 355-364.
40. LeGrow, J. ConocoPhillips Company, Houston, TX, USA, Personal communication, 2010.
41. Cleveland, C.J.; O'Connor, P.A. Energy return on investment (EROI) of oil shale. *Sustainability*, in press.

Appendix

Prices are from the Energy Information Administration Annual Energy Review 2009. Electricity price is taken as the total US average. Fuel oil price is assumed same as gasoline price. Both capital expenditures and the value of $e_{investment} = 14$ MJ/\$2005 for capital, or indirect energy, are taken from Guilford *et al.* (2011) of this special issue of *Sustainability* [18]. The value of MJ/\$2005 is calculated by summing all direct energy divided by the sum of all direct energy expenditures per Equation (9) when considering multiple direct energy inputs. The “MJ/\$2005 for total investment” is the basis for plotting the modeled price *versus* EROI in Figures 3 and 4.

Table A1. Prices for oil and natural gas [21] and EROI estimates from [26] and [18].

Year	US oil price (\$2005/BBL)	US NG price (\$2005/Mcf)	EROI Oil and Gas (Cleveland, 2005)[26]	EROI Oil and Gas (Guilford <i>et al.</i> , 2011)[18]
1919	--		--	17.13
1939	--		--	21.47
1954	17.05	0.61	17.86	23.71
1958	16.61	0.66	18.36	17.82
1963	15	0.83	21.32	19.02
1967	13.83	0.76	22.28	--
1972	12.73	0.71	24.24	19.84
1977	22.7	2.09	15.74	10.81
1982	51.47	4.44	12.56	7.75
1987	23.78	2.58	19.28	14.57
1992	20.89	2.27	21.41	16.63
1997	20.38	2.74	17.60	14.22
2002	24.44	3.2		15.16
2007	62.63	5.88		11.08

Table A2. Input values used to calculate $e_{investment}$ in MJ/\$2005 (MJ/\$ in final column) are based on data in [18].

Year	Energy Input	Fuel price	Price unit	Million \$2005 spent for energy inputs	MJ/\$2005
1954	Natural Gas	0.61	\$2005/Mcf	513.9	1652.4
	Fuel oil	74.676	\$2005/BBL	343.7	82.0
	Gasoline	1.778	\$2005/gal	--	--
	Electricity	0.09	\$2005/kWh	247.3	40.0
	Electricity (quality corrected)	0.09	\$2005/kWh	118.3	217.3
	Capital (indirect energy)	--	--	1896	14.0
				energy intensity for direct energy (MJ/\$2005)	925.3
				energy intensity for total investment (MJ/\$2005)	74.3
				million \$2005 invested in direct energy	975.9
				million \$2005 invested in indirect energy (capital)	13767.9
1958	Natural Gas	0.66	\$2005/Mcf	590.0	1527.0
	Fuel oil	70.434	\$2005/BBL	401.5	87.2
	Gasoline	1.677	\$2005/gal	167.7	71.6
	Electricity	0.09	\$2005/kWh	384.8	39.0
	Electricity (quality corrected)	0.09	\$2005/kWh	384.8	104.0
	Capital (indirect energy)	--	--	6994	14.0
				energy intensity for direct energy (MJ/\$2005)	639.9
				energy intensity for total investment (MJ/\$2005)	33.8
				million \$2005 invested in direct energy	1544.0
				million \$2005 invested in indirect energy (capital)	47237.9
1963	Natural Gas	0.83	\$2005/Mcf	801.0	1213.6
	Fuel oil	66.276	\$2005/BBL	364.5	93.3
	Gasoline	1.578	\$2005/gal	248.7	76.4
	Electricity	0.093	\$2005/kWh	622.7	38.5
	Electricity (quality corrected)	0.093	\$2005/kWh	622.7	101.2
	Capital (indirect energy)	--	--	8596	14.0
				energy intensity for direct energy (MJ/\$2005)	534.1
				energy intensity for total investment (MJ/\$2005)	32.5
				million \$2005 invested in direct energy	2036.9
				million \$2005 invested in indirect energy (capital)	55015.0

Table A2. Cont.

Year	Energy Input	Fuel price	Price unit	Million \$2005 spent for energy inputs	MJ/\$2005
1972	Natural Gas	0.71	\$2005/Mcf	826.4	1419.3
	Fuel oil	56.91	\$2005/BBL	1075.6	106.9
	Gasoline	1.355	\$2005/gal	166.5	90.1
	Electricity	0.071	\$2005/kWh	998.3	51.1
	Electricity (quality corrected)	0.071	\$2005/kWh	998.3	132.2
	Capital (indirect energy)	--	--	12927	14.0
				energy intensity for direct energy (MJ/\$2005)	467.9
				energy intensity for total investment (MJ/\$2005)	33.8
				million \$2005 invested in direct energy	3066.8
				million \$2005 invested in indirect energy (capital)	67221.4
1977	Natural Gas	2.09	\$2005/Mcf	2888.4	482.3
	Fuel oil	72.996	\$2005/BBL	2416.2	84.0
	Gasoline	1.738	\$2005/gal	388.3	69.5
	Electricity	0.09	\$2005/kWh	1771.1	40.1
	Electricity (quality corrected)	0.09	\$2005/kWh	1771.1	103.9
	Capital (indirect energy)	--	--	44638	14.0
				energy intensity for direct energy (MJ/\$2005)	242.1
				energy intensity for total investment (MJ/\$2005)	25.4
				million \$2005 invested in direct energy	7463.9
				million \$2005 invested in indirect energy (capital)	142842.6
1982	Natural Gas	4.44	\$2005/Mcf	4053.7	227.0
	Fuel oil	98.238	\$2005/BBL	5167.3	62.3
	Gasoline	2.339	\$2005/gal	803.4	52.3
	Electricity	0.11	\$2005/kWh	37.8	1111.6
	Electricity (quality corrected)	0.11	\$2005/kWh	3834.3	32.6
	Capital (indirect energy)	--	--	131585	14.0
				energy intensity for direct energy (MJ/\$2005)	116.2
				energy intensity for total investment (MJ/\$2005)	19.3
				million \$2005 invested in direct energy	13858.8
				million \$2005 invested in indirect energy (capital)	263170.2

Table A2. Cont.

Year	Energy Input	Fuel price	Price unit	Million \$2005 spent for energy inputs	MJ/\$2005
1987	Natural Gas	2.58	\$2005/Mcf	2609.4	390.5
	Fuel oil	61.488	\$2005/BBL	1279.0	99.3
	Gasoline	1.464	\$2005/gal	255.9	97.7
	Electricity	0.0984	\$2005/kWh	17.2	1453.5
	Electricity (quality corrected)	0.0984	\$2005/kWh	2796.3	36.5
	Capital (indirect energy)	--	--	55749	14.0
				energy intensity for direct energy (MJ/\$2005)	207.0
				energy intensity for total investment (MJ/\$2005)	27.3
				million \$2005 invested in direct energy	6940.6
				million \$2005 invested in indirect energy (capital)	94773.0
1992	Natural Gas	2.27	\$2005/Mcf	1993.1	418.0
	Fuel oil	61.866	\$2005/BBL	1546.7	98.9
	Gasoline	1.473	\$2005/gal	144.4	76.2
	Electricity	0.0891	\$2005/kWh	8.7	1259.8
	Electricity (quality corrected)	0.0891	\$2005/kWh	2943.5	40.4
	Capital (indirect energy)	--	--	56544	14.0
				energy intensity for direct energy (MJ/\$2005)	197.1
				energy intensity for total investment (MJ/\$2005)	28.1
				million \$2005 invested in direct energy	6627.6
				million \$2005 invested in indirect energy (capital)	79161.7
1997	Natural Gas	2.74	\$2005/Mcf	2937.3	367.7
	Fuel oil	61.278	\$2005/BBL	1838.3	100.1
	Gasoline	1.459	\$2005/gal	239.3	91.9
	Electricity	0.081	\$2005/kWh	13.3	1656.1
	Electricity (quality corrected)	0.081	\$2005/kWh	2656.6	44.4
	Capital (indirect energy)	--	--	74309	14.0
				energy intensity for direct energy (MJ/\$2005)	207.7
				energy intensity for total investment (MJ/\$2005)	29.5
				million \$2005 invested in direct energy	7671.5
				million \$2005 invested in indirect energy (capital)	89170.8

Table A2. Cont.

Year	Energy Input	Fuel price	Price unit	Million \$2005 spent for energy inputs	MJ/\$2005
2002	Natural Gas	3.2	\$2005/Mcf	2803.2	315.0
	Fuel oil	61.908	\$2005/BBL	1857.2	99.1
	Gasoline	1.474	\$2005/gal	147.4	169.6
	Electricity	0.0782	\$2005/kWh	7.8	3196.9
	Electricity (quality corrected)	0.0782	\$2005/kWh	2105.7	46.5
	Capital (indirect energy)	--	--	78518	14.0
				energy intensity for direct energy (MJ/\$2005)	194.8
			energy intensity for total investment (MJ/\$2005)	27.4	
			million \$2005 invested in direct energy	6913.5	
			million \$2005 invested in indirect energy (capital)	86369.8	
2007	Natural Gas	5.88	\$2005/Mcf	3722.0	171.4
	Fuel oil	110.754	\$2005/BBL	1000.8	55.0
	Gasoline	2.637	\$2005/gal	263.7	41.7
	Electricity	0.086	\$2005/kWh	8.6	1279.1
	Electricity (quality corrected)	0.086	\$2005/kWh	2192.7	42.0
	Capital (indirect energy)	--	--	188518	14.0
				energy intensity for direct energy (MJ/\$2005)	131.4
			energy intensity for total investment (MJ/\$2005)	18.6	
			million \$2005 invested in direct energy	7179.2	
			million \$2005 invested in indirect energy (capital)	177207.0	

Part II: EROI for Conventional Fossil Fuels

Article

A New Long Term Assessment of Energy Return on Investment (EROI) for U.S. Oil and Gas Discovery and Production

Megan C. Guilford ¹, Charles A.S. Hall ^{1,2,*}, Pete O' Connor ³ and Cutler J. Cleveland ³

¹ Department of Environmental Studies, State University of New York, College of Environmental Science and Forestry, Syracuse, NY 13210, USA; E-Mail: mcguilfo@syr.edu

² Program in Biology and Environmental Sciences, State University of New York, College of Environmental Science and Forestry, Syracuse, NY 13210, USA

³ Department of Geography and Environment, Boston University, Boston, MA 02215, USA; E-Mails: paconn@bu.edu (P.O.C.); cutler@bu.edu (C.J.C.)

* Author to whom correspondence should be addressed; E-Mail: chall@esf.edu; Tel.: +1-315-147-016-870; Fax: +1-315-470-6934.

Received: 5 June 2011; in revised form: 1 August 2011 / Accepted: 6 August 2011 /

Published: 14 October 2011

Abstract: Oil and gas are the main sources of energy in the United States. Part of their appeal is the high Energy Return on Energy Investment (EROI) when procuring them. We assessed data from the United States Bureau of the Census of Mineral Industries, the Energy Information Administration (EIA), the Oil and Gas Journal for the years 1919–2007 and from oil analyst Jean Laherrere to derive EROI for both finding and producing oil and gas. We found two general patterns in the relation of energy gains compared to energy costs: a gradual secular decrease in EROI and an inverse relation to drilling effort. EROI for *finding* oil and gas decreased exponentially from 1200:1 in 1919 to 5:1 in 2007. The EROI for *production* of the oil and gas industry was about 20:1 from 1919 to 1972, declined to about 8:1 in 1982 when peak drilling occurred, recovered to about 17:1 from 1986–2002 and declined sharply to about 11:1 in the mid to late 2000s. The slowly declining secular trend has been partly masked by changing effort: the lower the intensity of drilling, the higher the EROI compared to the secular trend. Fuel consumption within the oil and gas industry grew continuously from 1919 through the early 1980s, declined in the mid-1990s, and has increased recently, not surprisingly linked to the increased cost of finding and extracting oil.

Keywords: EROI; oil; gas; depletion; energy cost

1. Introduction

Petroleum, including crude oil, natural gas, and natural gas liquids, is industrialized society's most important fuel. Since its discovery in the United States in 1859, the use of petroleum has increased rapidly in both absolute terms and relative to other fuels. It accounted for about two thirds of total fuel use in the 1970s [1]. Since the oil crises of the 1970s, many entities within the United States have attempted to devise alternatives to oil. Nevertheless we consume today about the same proportion of petroleum as in the 1970s. As the easier-to-find and exploit resources are increasingly depleted, we have to turn to other, more difficult and expensive resources. The deep water Gulf of Mexico exploration and exploitation efforts are but one example. Getting oil from these more difficult environments is more expensive, and any oil company will tell you that the easy oil is gone.

It takes energy as well as money to produce energy. One important issue pertaining to petroleum availability in the United States is Energy Return on Investment (EROI), the ratio of energy returned compared to the energy used to get it. A more energy-intensive process of production, other things being equal, results in a lower energy return on energy (and dollar) investment. In theory, EROI takes into consideration all energies produced and all energies consumed to get that production. In practice, EROI is usually calculated from the direct and indirect energy used to produce a given amount of energy Murphy *et al.* in press [2].

The U.S. oil and gas industry is traditionally the most energy-using industry in the United States, and the energy intensity of getting energy did not escape the notice of M. King Hubbert, the most important analyst of oil production patterns in the United States, who mentioned it in his notes for his deposition before the 93rd U.S. Congress. However, few or no analysts attempted to quantify that relation until Hall and Cleveland undertook this analysis in 1981 [3]. They concluded that the energy found per foot of all types of drilling while seeking and producing oil and gas declined from about 50 barrels of oil (including gas on an energy basis) in 1946 to about 15 in 1978. They also found that the energy cost increased from about 0.1 to 2 barrels equivalent per foot. EROI was not calculated explicitly in that paper, but one can infer that the EROI implied by these data declined during that period from at least 50:1 to about 8:1. They also found that while the (inferred) EROI declined over time it was greatly influenced by the amount of drilling, and that a large amount of drilling effort in any given year was associated with a low EROI relative to the secular trend and the converse. Previously Davis had reported on a similar relation for return per drilling effort [4]. An update to the Hall and Cleveland study was published by Cleveland in 2005 [5] that estimated that the EROI for oil and gas for the United States had declined from a peak of about 30:1 in 1972 to about 13:1 in 1982, during a period of very intense drilling, but that the ratio had recovered to about 18:1 in 1997. He also found that if corrections were made for the quality of the different fuels the ratio had declined from 20:1 to about 11:1 from 1954–1997. Since the data that have been analyzed previously covered only a short time span (1946–1977 or 1954–2002 at best) our objective is to analyze the data, including

earlier and more recent data for a longer time span using a consistent methodology. We also compared the energy return on investment for both finding oil and producing it.

2. Methods

We derived a series of 13 point estimates for the EROI for U.S. oil and gas at mostly five-year intervals over the past 90 years. We did this for both discovery and for producing oil and gas. In each case the energy equivalent of the oil and gas found or produced was dividing by the sum of energy values of the estimates of the direct and indirect energy used in that year to produce that energy. We consider oil and gas together as the data on inputs are aggregated that way. While some of the petroleum produced or found for a given year came from past investments, and some of today's investments will not be reflected in production for a number of years, we believe this technique appropriate because most of the energy used in an oil field goes for pumping and pressurizing fields, so is related to contemporary production.

There are three analyses reported in this paper:

1. Oil and Gas discoveries: undertaken by Guilford and Hall;
2. Oil and Gas production undertaken by Guilford and Hall and independently by O'Connor and Cleveland, and considered preliminary.

When Guilford and Hall finished their analysis they found that O'Connor and Cleveland had begun the same analysis with some different assumptions. We include their preliminary analysis here as a sensitivity analysis of our own.

2.1. Methods to Derive EROI for Oil and Gas Discovery

We calculated the EROI of discovery of oil and gas from:

Equation:

$$\text{EROI} = \frac{\text{Mean quantity of energy discovered from oil and gas activities}}{\text{Quantity of energy used in that activity}}$$

Numerator:

We derived a five-point mean value of oil and gas discoveries (*i.e.*, mean of discoveries for the year in question and the two years before and two years after each year analyzed) from 1919 to 2007. Barrels of oil and barrels of oil equivalent of gas discovered were converted into GJ by multiplying by 6.118 GJ/BOE. Discovery data was supplied courtesy of Jean Laherrere (Table 3).

Denominator:

There is no clear procedure to derive how much of total effort is used for discovery and how much for development and production. In general about one third of the feet drilled are for exploratory, not development wells². But drilling is only part of the effort, and other uses of energy (e.g., pumping and pressurizing) are more concentrated in production. We estimated energy used by the exploratory wells from dollar cost data from 1992 to 2006 from John S. Herold^[5] by dividing exploratory dollar costs by

total costs (exploratory + developmental + production). We estimated energy used to find (vs. develop or produce) oil and gas by the average of the above quotient 16%, multiplied by the total energy use.

EROI for Oil and gas production (by Guilford and Hall):

Both groups compiled data sets of the direct and indirect energy used for producing oil and gas for the United States from official government sources including publications and websites. We all calculated EROI from the following equation:

$$\text{EROI} = \frac{\text{Quantity of Energy Supplied from oil and gas produced}}{\text{Quantity of Energy used in that activity}}$$

Numerator:

We all used production data (total energy gained through production) for the United States from two data sources: the Energy Information Administration [1] and the production summary table from the Oil and Gas Journal and from online versions of each last issue of February from 1978 and earlier until 2010 in print at Cornell University (Table 5). We then converted the raw physical units of output to Joules using the conversion factors from Table 1.

Table 1. Conversion values from physical or energy units to Joules (from MIT Department of Physics, Energy info card/Physics of energy version 8.21).

Units	Conversion
1 barrel of Oil Equivalent	5.8×10^6 BTU = 6.118 GJ
1 kilowatt-hour (kWh)	3.6 MJ
1 BTU	1.055 kJ = 1,055 J
1 barrel of oil (bbl)	<u>42 gallons= 5.615 cubic feet = 159.0 liters</u>
Gasoline	121.3 MJ/gal (32.1 MJ/L or 43.1 MJ/kg or 115 mBTU/gal)
Crude Oil	6.119 GJ/bbl = 5.8 mmBTU/bbl or 39.7 mmBTU/ton or 145.7 MJ/gal or 38.5 MJ/L or 43.8 MJ/kg (=GJ/ton)
1 cubic foot of natural gas	1,008 to 1,034 BTU
1 therm of natural gas	100,000 BTU = 98 cubic feet
1 gallon of crude oil	138,095 BTU = 145.7 MJ
1 barrel of crude oil	5.8 Mega BTU = 6.1 MJ
1 gallon of residual fuel oil	149,690 BTU = 158 GJ
1 gallon of gasoline	125,000 BTU = 132 GJ

Denominator:

Guilford and Hall estimated oil and gas industry-specific energy costs from data from the United States Bureau of the Census of Mineral Industries from 1919 to 2007 (Tables 5 and 6). The publications of the Census of Mineral industries are in print until only 1992. More recent data were derived from the Energy Information Administration (EIA) website as well as the online version of the Census of Mineral Industries. There were major changes in their format, but we believe we interpreted the new data correctly. In some few cases, as identified in A-1, we had to make educated guesses.

More specifically, we used summary tables from the Census of Mineral Industries (CMI) from 1919 to 1992 for on-site energy use. The Bureau of the Census of Mineral Industries publishes data every

five years; however the criteria used to organize the data changed periodically, especially for 1997 and following, sometimes making it very difficult to interpret their tables. For example, the online version of the CMI, which was used for more recent data, is in a different format than the print version for years in which they overlap (e.g., 1992). CMI continues to supply estimates of physical quantities of natural gas (the most important fuel) used, but for some reason (apparently “insufficient data quality”), it gives the quantity of oil only in monetary terms subsequent to 1992, which we converted to physical quantities from mean annual price Appendix (A-1). Electricity is electricity not generated on site but purchased. We next converted these raw physical units (barrels, billion cubic feet, kilowatt-hours, *etc.*) into Joules using conversion factors from Table 1.

Indirect (offsite) energy costs were derived by multiplying inflation-corrected expenditures for capital goods and materials bought by the oil and gas industry by a factor approximating the energy intensity of the oil and gas industry expenditures (14 MJ/\$ per 2005 dollar [6]) with a sensitivity analysis using a low estimate (8.3 MJ/\$, the mean energy use for the society as a whole) and high energy use (20 MJ/\$ for the oil and gas industry [6]). After 1972 the energy associated with producing and supplying these indirect costs often were higher than the direct use (A-1, in Appendix, summarized in Table 3). We then summed all of these energy values from the direct and indirect energy costs to give a total energy cost. This is equivalent to the standard assessment (EROI_{st}) recommended by Murphy *et al.* in press [2].

After converting the raw physical units of both the energy costs and gains to energy we divided the total energy gains (finding or production data) by the total direct and indirect energy cost (fuel consumed) to calculate an EROI value for each year at five-year intervals from 1919 to 2007. Annual drilling intensity data (exploratory plus production, in million feet per year) is from the Energy Information Administration [1] website.

2.2. Difficulties with Missing Data

Generally the Census of Mineral Industries (CMI) gave quite complete energy cost analyses, especially in the middle years of this analysis, but sometimes, and increasingly in recent years, data was omitted for direct energy consumption in order to “avoid disclosing proprietary information”. In some cases CMI stated energy expenditures for specific fuels, in others CMI stated dollar energy expenditures, and in a few cases no inference from expenditures was possible. The inferences of missing values are uncertain, but we present them here as a secondary analysis.

Where CMI gave only dollar amounts for specific fuels within some sub-sectors, we used monetary costs by multiplying adjacent energy dollar rankings to derive the physical quantities consumed. Where sub-sectors had quantities reported but no price associated, we used EIA price series (annual averages) to determine the dollar value. Occasionally neither expenditures nor quantities were available for self-use of natural gas, so we interpolated as best we could.

We assumed that self-use of natural gas in the Natural Gas Liquid (NGL) Extraction sub-sector in 2007 was proportional to the electricity consumption in that sector, at the same ratio as in 2002. Therefore, we estimated that because electricity use decreased 14.5% from 2002 to 2007, the amount of natural gas for “self-use” was 14.5% below 2002 levels. This is a fairly large value, equal to 30% of the gas consumed in that year, and it is relatively uncertain. As it is self-use, no cost information is

available to make a better estimate. Self-use of crude petroleum is seen in the Petroleum and Natural Gas Extraction sub-sector for 1992 and 1997, but no values are reported for 2002 or 2007. However, this is a small fraction of energy use, accounting for less than 1% of overall energy use in 1992 and 1997. Therefore, we have not attempted to estimate self-use of crude petroleum. Note that consideration of self-use of natural gas raises the issue of whether to look at “External Energy Return” (EER) or “Net Energy Return” (NER). We assume that there is an opportunity cost to using the natural gas in most cases of domestic oil production, and so include self-use in our EROI, making it an NER analysis. It would be omitted for an EER analysis, leading to a higher value for EROI.

Where specific energy quantities were unknown, but the total energy expenditures were known, we distributed the unaccounted-for energy among the various unknown categories equal to the distribution in nearby years. The amount of energy so distributed never exceeded 7% of total energy cost. For example, in 2002, the “Support Services” sub-sector listed neither expenditures nor quantities for natural gas, nor for residual and heavy diesel. There was \$93,311,000 in energy costs unaccounted for in that sub-sector. We divided the residual cost among the two fuels based on their 2007 ratio, with 47.5% going to residual and heavy diesel, and 52.5% going to natural gas. We then used total price data from EIA to determine the quantities of those fuels consumed.

A considerable amount of energy is categorized as either “other” (possibly including minor fuels such as petroleum coke), or “undistributed” (reported by small firms on a shorter survey form). These range from 8–16% of total energy consumption over the years 1992–2007. We assumed that these other fuels were natural gas and added them to gas, as natural gas represents the overwhelming majority of known direct energy consumption by the “other” and “undistributed” fuels. This increases the direct energy consumption slightly compared to the case in which these expenditures are distributed among the various energy resources, because natural gas is the least expensive per BTU of the fuels used over the period 1992–2007. The total effect of these assumptions is shown in Table 2.

Table 2. Changes in Direct Energy using Alternative Analysis.

Year	Fuel type	Original Value	Alternative Value	Calculation
1992	Natural gas	878 Bcf	1,042 Bcf	Included “other” and “undistributed” fuels as natural gas
1997	Natural gas	1,072 Bcf	1,207 Bcf	Included “other” and “undistributed” fuels as natural gas
2002	Natural gas	876 Bcf	1,018Bcf	Inferred missing values for support and drilling natural gas consumption from expenditures; Included “other” and “undistributed” fuels as natural gas
2002	Fuel oil	30 Mbbl	9.0 Mbbl	Inferred from known total energy expenditures and known price of fuel oil
2002	Gasoline	100 M gal	71.8 M gal	Inferred from known gasoline expenses and average cost for that year
2007	Natural gas	633.2Bcf	1183Bcf	Added estimate of 339 Bcf of self-use in the NGL Extraction sub-sector; Calculated 160.3 purchased (all sectors) on known price; Included “other” and “undistributed” fuels as natural gas
2007	Fuel oil	9.03 Mbbl	14.05 Mbbl	Inferred from known total energy expenditures and known price of fuel oil
2007	Gasoline	100 M gal	211 M gal	Inferred from known gasoline expenses and average cost for that year

For capital expenditures, O'Connor and Cleveland's analysis uses the current-cost depreciation series from the Bureau of Economic Analysis for Sector 2110, Oil and Gas Extraction, rather than the capital expenditures from the CMI. The use of the depreciation series produces the changes seen in Table 3, below.

Table 3. Changes in Capital Expenditures for Alternative Analysis.

Year	Capital expenditures (\$M, nominal)	Depreciation (\$M, nominal)
1972	3,456	3,433
1977	12,944	8,969
1982	42,216	27,141
1987	11,717	20,868
1992	12,520	22,506
1997	25,152	25,051
2002	28,781	38,110
2007	125,460	84,010

2.3. Avoidance of Double-Counting

For materials and supplies, the Census of Mineral Industries is used as in the primary analysis, but the series is corrected to eliminate the feedstock inputs. The natural gas liquids extraction sector purchases large amounts of natural gas as a feedstock, not as a fuel; it extracts the liquids and then sells both of the products. Because the energy involved in producing the gas has already been accounted for in the "direct energy inputs," it is not appropriate to include it as a material expenditure for calculating indirect energy inputs. Therefore, we subtract the estimated proportions of natural gas feedstocks from the cost of materials purchased by the sector. For the years 1972–1982, the specific cost of natural gas feedstocks was not available, so we applied feedstock's share of NGL materials cost in 1987–2007 to the known NGL materials cost for 1972–1982. The feedstock represents about 43% of total materials expenditures (all sub-sectors) over the period 1972–2007. The effect is shown in Table 4.

Table 4. Correction for Subtracting Feedstock.

Year	Materials (\$M, nominal)	Without Feedstock (\$M, nominal)
1972	9,471	5,555
1977	31,694	18,004
1982	89,370	57,934
1987	44,032	24,087
1992	44,092	21,788
1997	49,157	29,981
2002	48,032	25,683

A second issue of possible double-counting could not be easily avoided. The Census of Mineral Industries includes "Contract Work" in the overall category of "Total Cost of Supplies". If a company within the sector outsources work to another company in the sector, the energy use of the contractor is

already included in the direct energy consumed by the sector. It would then be inappropriate to apply the indirect emissions factor of 14 MJ/\$ to the Contract Work, and the “Total Cost of Supplies” would have to be reduced by this amount. On the other hand, if the contracting company does not report to CMI in the oil and gas production sector (perhaps it is a general engineering firm, an engine manufacturer, a road-building firm, or some other sort of company), then it is appropriate to apply the indirect emissions factor. However, we have not yet identified a means to separate the Contract Work into work done by companies in this sector and work done by companies not in this sector. The analysis at present includes the “Total Cost of Supplies” without removing the within-sector Contract Work, and so likely overstates this indirect energy cost. “Contract Work” is roughly 20% of “Total Cost of Supplies” in 1997, 2002, and 2007. If half of the contract work was double-counted, then the actual indirect energy would be reduced by about 10%, and so the actual total energy inputs would be reduced by perhaps 5% (if indirect energy were half of all energy).

The three major changes we made in the empirical data set from CMI are then:

- (1) Missing values are inferred for direct energy consumption, and “other” and “undistributed” fuels are included for 1992–2007;
- (2) Depreciation series from BEA are used instead of CMI for capital; and, CMI data series for materials were corrected to eliminate NGL feedstock. The cumulative effect of these three changes is given in “sensitivity analysis”, below.

3. Results

EROI for *discoveries* declined sharply from over 1200 to 1 for 1919 to 5:1 in 2007 (Figure 1 and Table 5). EROI for *production* of the oil and gas industry (with no quality corrections) were about 20:1 from 1919 to 1972, declined to about 8:1 in 1982, when peak drilling occurred, recovered to about 17:1 during low drilling years 1986–2002 and declined sharply to about 11:1 in the mid-late 2000s (Figure 2). There is an inverse relation between the energy return on investment and the drilling rates so that after 1957 EROI tends to be higher when the drilling rate is lower (Figure 3 and 3b).

Figure 1. EROI for discoveries for the U.S. Oil and Gas Industry. The inset is the same data plotted on a different scale.

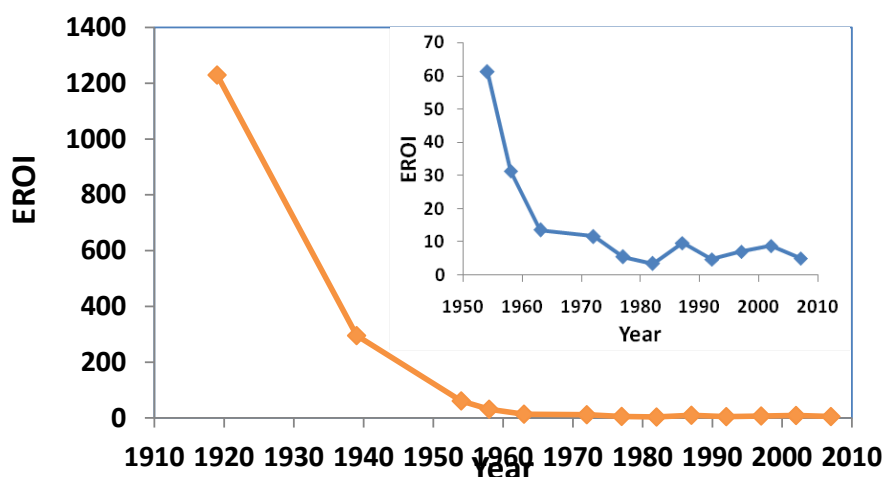

Table 5. Estimates of energy costs, gained and EROI associated with energy discovered by the U.S oil and gas industry. Oil and gas discovered courtesy of Jean Laherrere.

Year	Direct + Indirect Total	Exploration/total cost average %	Direct + Indirect Total Exploration	Discovery (GJ)	EROI
1919	171	0.16	26.87	33.04	1229.48
1939	567	0.16	89.10	26.31	295.26
1954	1096	0.16	172.23	10.52	61.10
1958	1652	0.16	259.60	8.14	31.34
1963	1859	0.16	292.12	3.98	13.61
1972	2378	0.16	373.68	4.34	11.62
1977	3826	0.16	601.22	3.30	5.50
1982	5345	0.16	839.91	2.88	3.42
1987	2779	0.16	436.69	4.22	9.67
1992	2463	0.16	387.04	1.84	4.74
1997	2860	0.16	449.42	3.18	7.08
2002	2548	0.16	400.39	3.55	8.86
2007	3569	0.16	560.83	2.81	5.02

Figure 2. EROI for production for the U.S. Oil and Gas Industry. Column two is total energy costs, and column four is estimated costs for discovery alone.

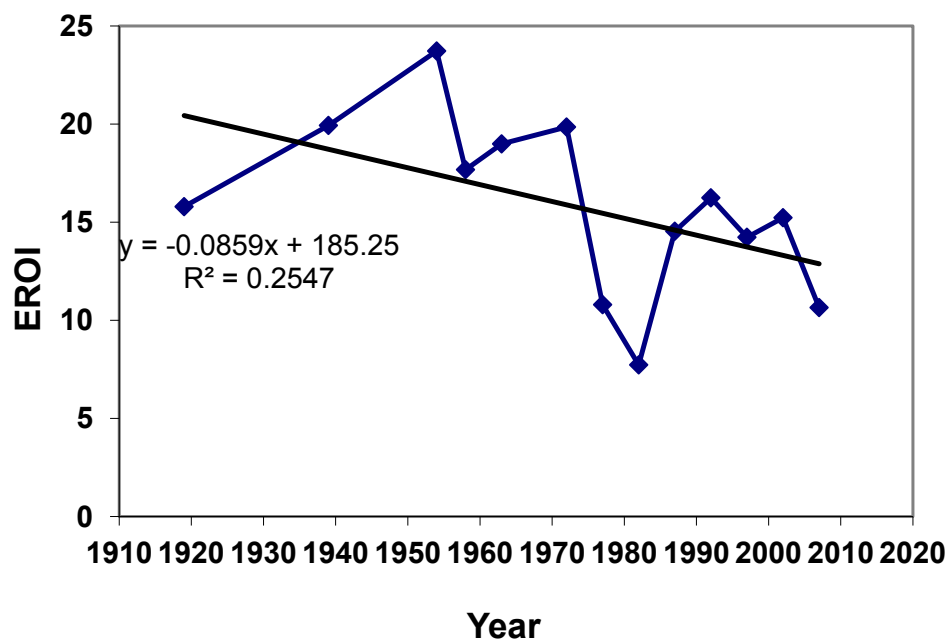

Figure 3. EROI and drilling intensity for same year. Note inverse relation, especially after 1957 between drilling rate and EROI. Increased drilling does not necessarily generate more oil produced because the EROI decreases with high drilling efforts after 1958.

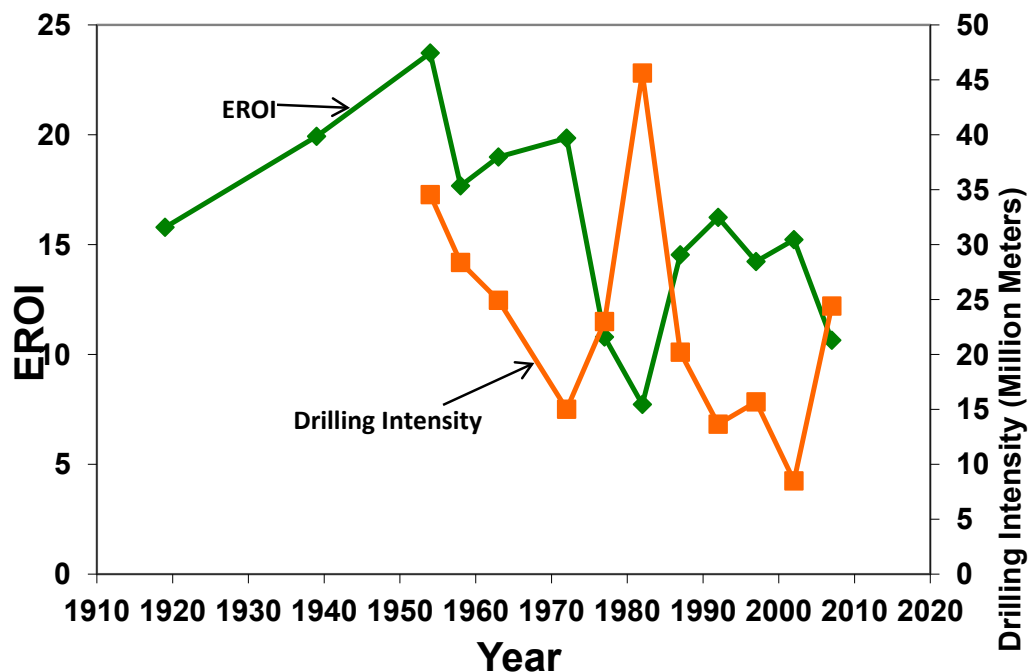
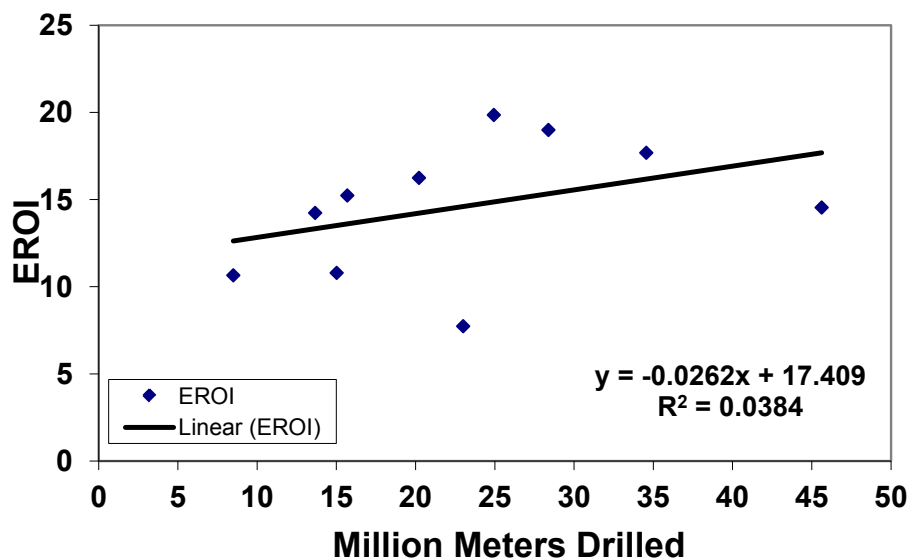

Figure 4. EROI vs. drilling intensity for same year.



Energy input: The input of energy is dominated by the energy required to make equipment and then natural gas used on site. There was a sharp peak in 1982 following the price increases of the 1970s and a second, smaller peak in 2007 (Figure 5 and Table A-1 in Appendix).

Figure 5. Energy consumed within the U.S. oil and gas industry (Data from the U.S. Bureau of Census of Mineral Industries). Data summarized in Table 6.

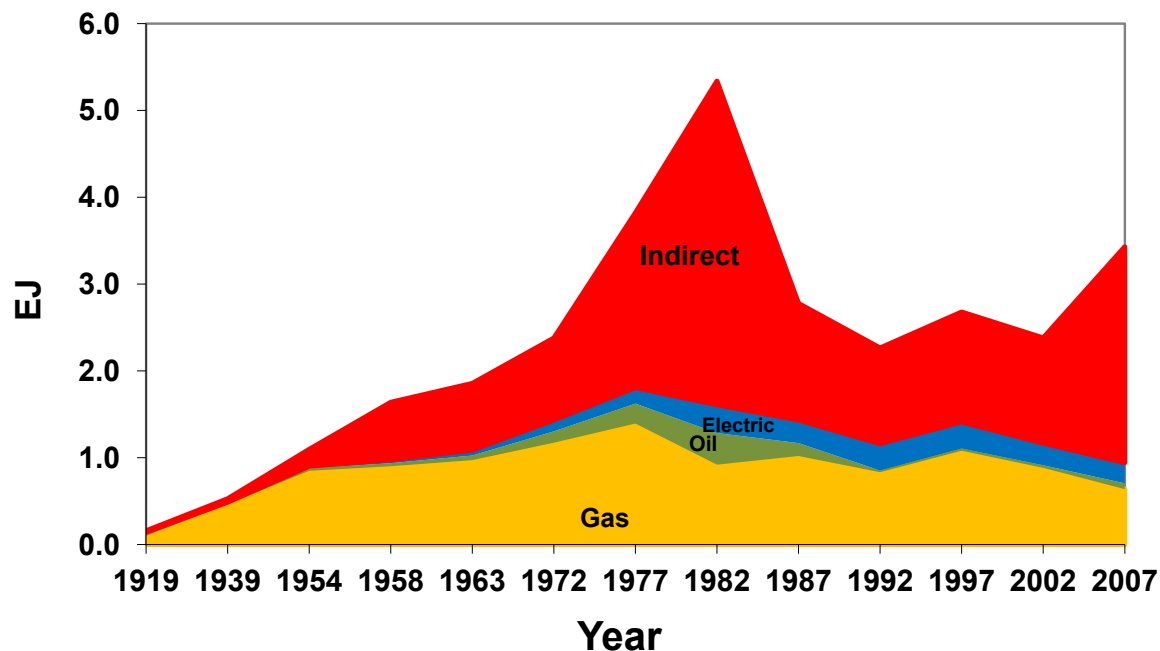

Table 6. Estimates of energy costs, gained and EROI associated with energy produced by the U.S. oil and gas industry.

Year	Energy Gains (Production) Total (EJ)	Direct Energy Total (PJ)	Indirect Energy Total (PJ)	Direct + Indirect Total	Production EROI
1919	2.70	139.2	32.0	171	15.79
1939	11.31	488.0	79.0	567	19.93
1954	25.98	53.9	193.0	1096	23.72
1958	29.19	991.0	661.0	1652	17.68
1963	35.28	1091.2	768.0	1859	18.99
1972	47.17	1435.3	943.0	2378	19.85
1977	41.29	1812.4	2013.0	3826	10.79
1982	41.33	1618.6	3727.0	5345	7.73
1987	40.44	1437.6	1342.0	2779	14.54
1992	40.03	1361.5	1101.0	2463	16.24
1997	40.66	1595.0	1265.0	2860	14.23
2002	38.75	1336.2	1212.0	2548	15.23
2007	37.99	1084.6	2485.0	3569	10.65

3.1. Sensitivity Analysis of Results

Energy output: The production of oil and gas increased from 422 million barrels oil equivalent (BOE) in 1919 to a peak of 3,517 in 1970 and then declined to 1,811 in 2008. We compared EIA and Oil and Gas Journal of production data and they were not significantly different (Figure 6).

Figure 6. U.S. Oil and Gas Production (Megabarrels of oil equivalent/day). Data from the Energy Information Administration and Oil and Gas Journal. 10 million barrels of oil per day equivalent translates to 22.3 Exajoules per year.

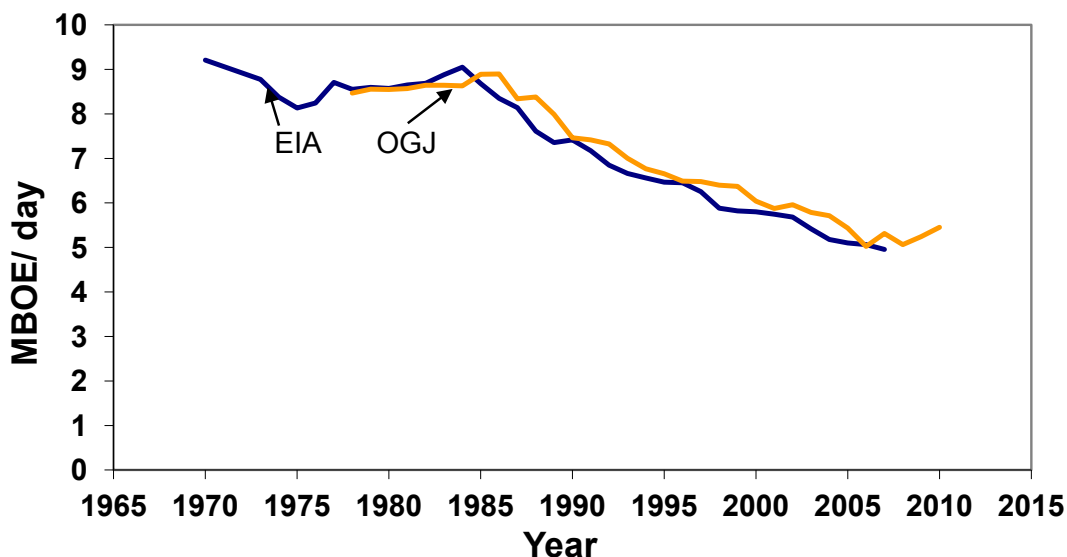

The greater direct energy consumption in the alternative analysis (caused by inferring values where CMI data is missing) partially offsets the reduced indirect energy consumption (caused by removing the natural gas feedstock from the materials purchased by the NGL sector). The resulting EROI is similar to, but slightly higher than, the EROI found in our original analysis.

The energy intensity (*i.e.*, the energy associated with each dollar spent for indirect expenditures is not known with certainty. One can derive a value of 14.5 MJ used per 2005 dollar spent from the Carnegie-Mellon Green energy web site for oil and gas exploration and discovery. We used a value of 8.3 MJ/\$ (average for the entire society for a minimum estimate, and a value of 20 MJ/\$ (average for direct and indirect for the U.S. and UK oil and gas industry for 2005 [6] for an upper limit (Figure 7). This sensitivity analysis indicates a maximum difference of a little more than a factor of two. Since the indirect costs are about half of total costs these uncertainties would add no more than a little more than 25% uncertainty to the final EROI values. Since the middle value seems much the most likely the actual uncertainty is less than this.

We also undertook an “extreme” sensitivity analysis by comparing our results with a completely independent assessment undertaken (without our knowledge) by O’Connor and Cleveland (Figure 8) The results suggest very similar patterns and, generally values, except that O’Connor and Cleveland’s values are about 15–25% higher for the 1970s and early 1980s. Much of this difference appears due to their use of depreciation *vs.* Guilford and Hall’s use of capital expenditures for indirect cost estimates (Table 3).

Figure 7. Sensitivity Analysis for indirect energy consumed by the U.S. oil and gas industry.

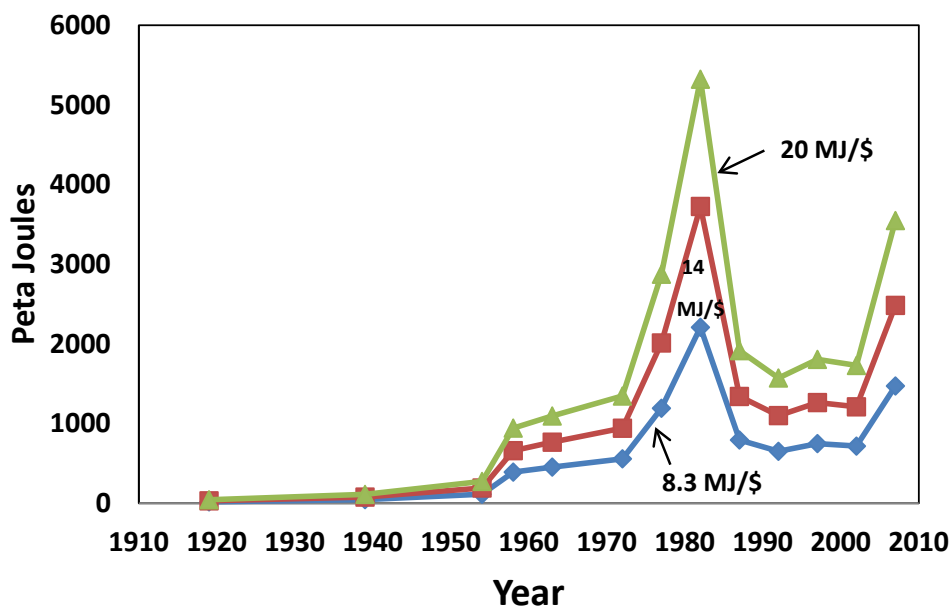

Figure 8. Sensitivity Analysis comparison with the independent analysis of O'Connor and Cleveland. Note that the values for O'Connor and Cleveland do not exactly match those in Table 7, as that table simply shows the effect of the three most significant differences in methodology. Several other minor differences also exist.

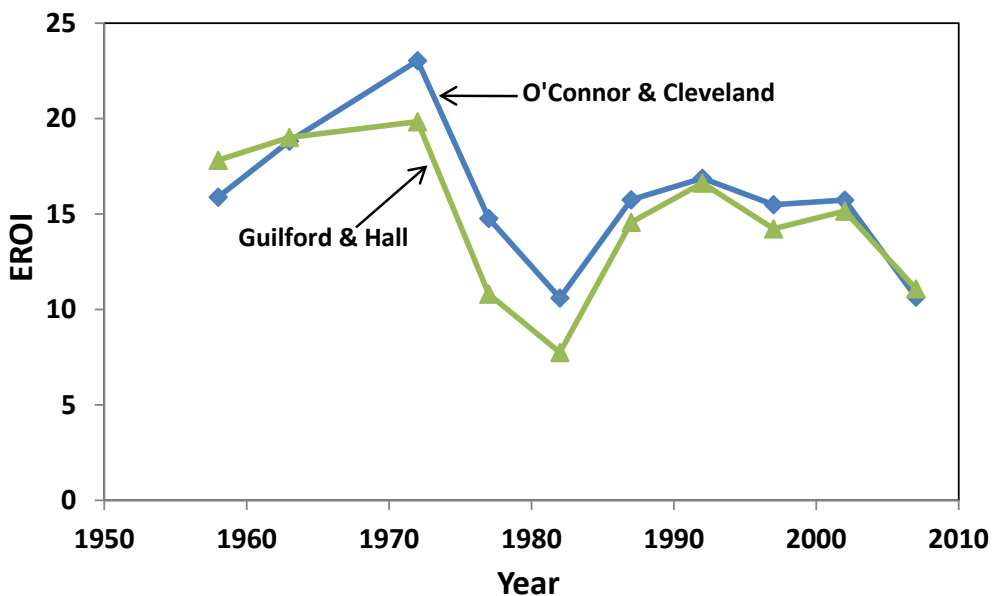
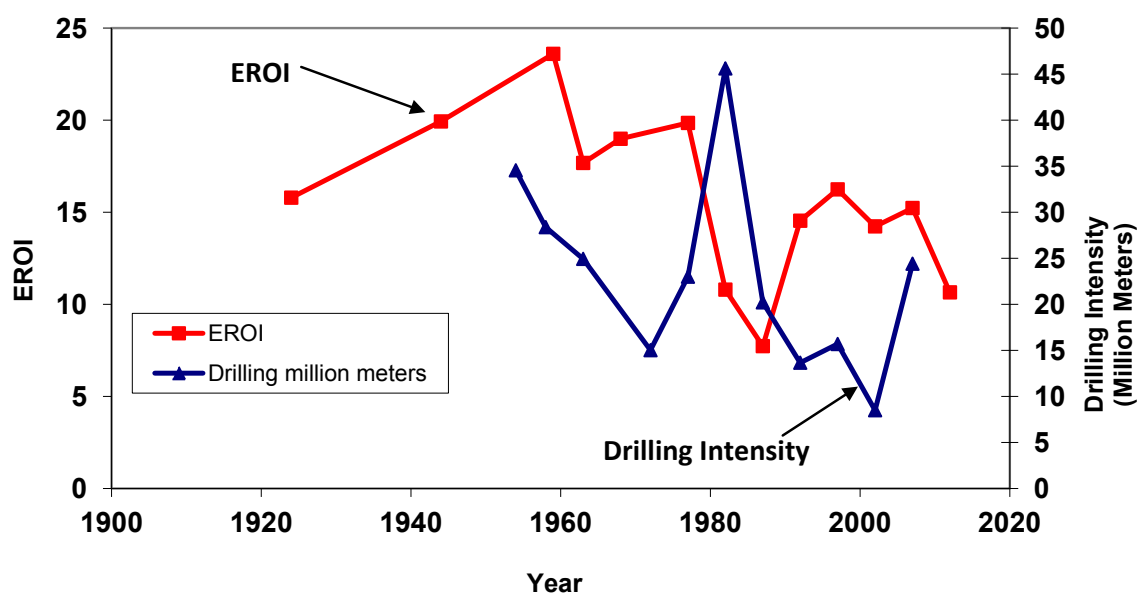

Table 7. Changes in Alternative Analysis 1972–2007.

Year	Output (EJ)	Original				Alternative			
		Direct (PJ)	Indirect (PJ)	EROI	% Indirect	Direct (PJ)	Indirect (PJ)	EROI	% Indirect
1972	47.17	1435.3	943	19.8	39.7%	1435.3	654	22.6	31.3%
1977	41.29	1812.4	2013	10.8	52.6%	1812.4	1208	13.7	40.0%
1982	41.33	1618.6	3727	7.7	69.7%	1618.6	2382	10.3	59.5%
1987	40.44	1437.6	1342	14.5	48.3%	1437.6	1070	16.1	42.7%
1992	40.03	1361.5	1101	16.2	44.7%	1426.6	868	17.4	37.8%
1997	40.66	1595.0	1265	14.2	44.2%	1630.1	925	15.9	36.2%
2002	38.75	1336.2	1212	15.2	47.6%	1380.5	982	16.4	41.6%
2007	37.99	1084.6	2485	10.6	69.6%	1554.9	1546	12.3	49.9%

One of our reviewers was especially interested in the possible time lag effect—that drilling at one point in time might produce oil at a later time. We investigated this by slipping the production relative to the investment. The results showed no particular change in the basic patterns of EROI over time although it decreased somewhat the inverse relation between effort and EROI (Figure 9).

Figure 9. Time lag in the EROI value five years after the drilling occurred. An inverse correlation is still present between the EROI and the drilling intensity (effort).



4. Discussion

Oil and gas production has been decreasing steadily since its peak in 1970 and a second, smaller peak in 1985 when Alaska came on line (Fig.4). The maximum production in 1970 was about 9 million barrels equivalent per day. Data from the EIA and the Oil and Gas Journal show that the most recent production is roughly 5 million barrels equivalent per day, with an increasing proportion being gas. The U.S EROI has fluctuated over time but there is an overall negative trend over time,

especially since 1950 (Figure 1). The reason that EROI is dropping is because the finding and production of oil is steadily decreasing and our energy investment is increasing. Gas production has remained approximately flat, mostly due to unconventional resources replacing faltering conventional resources. The remarkably high EROI for finding oil and gas in early years contributed to significant increases in GDP and probably had a great deal to do with a tremendous increase in wealth in the first part of the 20th century, as well as to the development of systems based on inexpensive and abundant petroleum. Its steep decline is equally remarkable.

A higher demand for oil, sometimes driven by falling supplies, increases prices, which encourages more drilling, but ironically more drilling does not mean that more oil and gas will be found. There is a clear inverse correlation between EROI and drilling rates (Figure 3a). It appears likely that petroleum supplies will continue to diminish no matter how much money is invested into drilling. It is possible for production to increase even as EROI decreases, as happened, for example, over the period 1950–1970. However, the U.S. has been in a long period of decreasing EROI and decreasing production, suggesting that depletion has more importance than technology. The EROI has a shape similar to the Hubbert curve (although tilting to right) and confirms that we are most definitely in the second half of the age of oil for U.S domestic oil supply (Figure 2). Most direct energy used is natural gas in oil and gas production, and since oil but not gas needs considerable energy to pump or pressurize the formation, it is likely that natural gas is subsidizing oil production and that the EROI for oil alone would be much lower.

We checked the sources of the data for the numerator (energy gains) and the denominator (energy inputs) of the EROI equation throughout our study. We found that most of the data was not too difficult to find until 1992. Post 1992 there have been many different formats and tables for the fuel consumed within the oil and gas industry, which made our assessment more difficult. A more disturbing trend is that over time the data sets are less complete. Given the critical trends we see and the need to continue these analyses this is a very disturbing finding. Recent funding cutbacks for the U.S. Energy Information agency are likely to contribute to a further decline in data quality and quality as that information becomes far more critical.

We conducted numerous sensitivity analyses which took into consideration different indirect energy costs, an independent preliminary EROI study from O'Connor and Cleveland and a time lag in response to drilling intensity and EROI. Indirect energy costs are not known with certainty since the excellent earlier work at the University of Illinois was disbanded decades ago. We took into consideration different quality energy corrections and used 14 MJ/\$ for our analysis, a value defensible from the Carnegie-Mellon site (2002 data corrected for inflation to 2005) and also by correcting for inflation earlier values from the University of Illinois studies (Figure 7). We used 14 MJ/\$ for comparison purposes with previous studies. None of the uncertainty assessment patterns or even values for EROI over time changed in any significant way (*i.e.*, usually much less than about 25%) our basic results.

There are sources of energy that may delay the beginning of the end of cheap oil. Unconventional sources of oil such as tar sands, natural gas extraction through hydraulic fracturing and off shore drilling may add to our supply of energy but will probably be expensive once the “cream” is skimmed from the sweet spots. Technology has not alleviated the problem of decreasing EROI and may not be able to do that in the future as depletion of highest quality resources continues. Thus society probably

faces a continuing decline in the EROI of both conventional oil and gas. The EROI of most alternatives to conventional hydrocarbons is also low, so that the EROI of the future seems unlikely to be high enough to support society as a whole in the format we are familiar with [7].

5. Conclusion

As time goes on, domestic oil production continues to decline while energy exploitation efforts increase as the easy oil and gas is depleted. The age of cheap oil is coming to an end. The decreasing EROI of the oil industry is a factor contributing to the end of cheap oil. The EROI for production for the United States' oil industry dropped from roughly 24:1 in 1954 to 11:1 in 2007. Over time more energy is used to find and produce the same or less petroleum. Depletion tends to lead to lower petroleum production, but it also gives incentives for increased exploration, both of which contribute to a diminishing EROI. Demand for oil and gas has tended to increase steadily over time, which in turn accelerates both drilling and further depletion. The EROI is a reflection of the efficiency within a given system. As the EROI of domestic oil and gas, the nation's most important fuel supplies, continues to drop off it makes a sustainable society increasingly difficult. We must adjust to this new reality by using less, rather than expanding drilling efforts.

Acknowledgements

We thank Susan Bucci of the Bureau of Census for helping us through the maze of the Census' data, Doug Hansen for helping to improve the wording, and two anonymous reviewers. We thank Mason McMahan for early help with obtaining and graphing data. We would like to thank Jean Laherrere for the data he supplied us to derive EROI for both finding and producing oil and gas. Special note from the first author: I would like to thank my parents for their support and always encouraging me to strive to do my best.

References and Notes

1. Energy Information Administration (EIA). Official Energy Statistics from the U.S. Government. Publisher: Available online: <http://www.eia.doe.gov> (accessed on 4 May 2010).
2. Murphy, D.; Hall, C.A.S.; Dale, M.; Cleveland, C. Order from chaos: A preliminary protocol for determining the EROI of fuels. *Sustainability*, in press.
3. Hall, C.A.S.; Cleveland, C.J. Petroleum drilling and production in the United States: Yield per effort and net energy analysis. *Science* **1981**, *211*, 576-579.
4. Davis, W. A study of the future productive capacity and probable reserves of the U.S. *Oil Gas J.* **1958**, *56*, 105-119.
5. Cleveland, C.J. Net energy from the extraction of oil and gas in the United States. *Energy* **2005**, *30*, 769-782.
6. Gagnon, N.; Hall, C.A.S.; Brinker, L. A preliminary investigation of energy return on energy investment for global oil and gas production. *Energies* **2009**, *2*, 490-503.
7. Hall, C.A.S.; Balogh, S.; Murphy, D.J. What is the minimum EROI that a sustainable society must have? *Energies* **2009**, *2*, 25-47.

Appendix

Table A-1. Raw data and calculations used for estimating energy costs for U.S. oil and gas industry. Values in yellow are rough interpolations or extrapolations based on neighboring years.

Year	Type	Raw value(#)	Original Units (M= 10 ⁶)	Conversion	To Metric (or other)	Units	Energy Density	Total Energy	Units
1919	N. Gas	100	Bcf	0.028	2.8	E9m ³	36	101	PJ
							6.118		
1919	Fuel oil	5.9	Mbbls				(GJ/bbl)	36	PJ
							6.118		
1919	Gasoline	1.9	Mgal	42	0.045	Mbbls	(GJ/bbl)	0.277	PJ
			M(kWh)				3.6		
1919	Electric	285	(=GWh)			kWh	TJ/kWh	1	PJ
	Electric		M(kWh)		Fossil Fuel		3.6		
1919	(QC)	285	(=GWh)	2.6	Equiv.	kWh	TJ/kWh	2	PJ
1919	Capital	200	Mdollars	11.3	2259	2005	8.3 MJ/\$	19	PJ
1919	Capital *	200	Mdollars	11.3	2259	2005	14 MJ/\$	32	PJ
1919	Capital	200	Mdollars	11.3	2259	2005	20 MJ/\$	45	PJ
1919	TOTLO	-	-	-	-	-	-	157	PJ
1919	TOTAL *	-	-	-	-	-	-	170	PJ
1919	TOTQC *	-	-	-	-	-	-	171	PJ
1919	TOTHIQC	-	-	-	-	-	-	184	PJ
1939	N. Gas	462.1	Bcf	0.028	12.9388	E9m ³	36	466	PJ
							6.118		
1939	Fuel oil	2.2	Mbbls				(GJ/bbl)	14	PJ
							6.118		
1939	Gasoline	17.7	Mgal	42	0.42	Mbbls	(GJ/bbl)	3	PJ
			M(kWh)				3.6		
1939	Electric	651.0	(=GWh)			kWh	TJ/kWh	2	PJ
	Electric		M(kWh)		Fossil Fuel		3.6		
1939	(QC)	651.0	(=GWh)	2.6	Equiv.	kWh	TJ/kWh	6	PJ
1939	Capital	399.8	Mdollars	14.1	5619.2	2005	8.3 MJ/\$	47	PJ
1939	Capital *	399.8	Mdollars	14.1	5619.2	2005	14 MJ/\$	79	PJ
1939	Capital	399.8	Mdollars	14.1	5619.2	2005	20 MJ/\$	112	PJ
1939	TOTLO	-	-	-	-	-	-	531	PJ
1939	TOTAL *	-	-	-	-	-	-	563	PJ
1939	TOTQC *	-	-	-	-	-	-	567	PJ
1939	TOTHIQC	-	-	-	-	-	-	600	PJ
1954	N. Gas	842.4	Bcf	0.028	23.5872	E9m ³	36	849.1	PJ
							6.118		
1954	Fuel oil	4603	Mbbls				(GJ/bbl)	28.2	PJ

Table A-1. Cont.

Year	Type	Raw value(#)	Original Units (M= 10 ⁶)	Conversion	To Metric (or other)	Units	Energy Density	Total Energy	Units
							6.118		
1954	Gasoline	-	Mgal	42	-	Mbbls	(GJ/bbl)	-	PJ
			M(kWh)				3.6		
1954	Electric	2748	(=GWh)			kWh	TJ/kWh	9.9	PJ
	Electric		M(kWh)		Fossil Fuel		3.6		
1954	(QC)	1314	(=GWh)	2.6	Equiv.	kWh	TJ/kWh	25.7	PJ
							8.3		
1954	Capital	1896.4	Mdollars	7.3	13767.9	2005	MJ/\$	114	PJ
1954	Capital *	1896.4	Mdollars	7.3	13767.9	2005	14 MJ/\$	193	PJ
1954	Capital	1896.4	Mdollars	7.3	13767.9	2005	20 MJ/\$	275	PJ
1954	TOTLO	-	-	-	-	-	-	1001	PJ
1954	TOTAL *	-	-	-	-	-	-	1080	PJ
1954	TOTQC *	-	-	-	-	-	-	1096	PJ
1954	TOTHIQC	-	-	-	-	-	-	1178	PJ
1958	N. Gas	894.3	Bcf	0.028	25.0404	E9m ³	36	901	PJ
							6.118		
1958	Fuel oil	5.7	Mbbls				(GJ/bbl)	35	PJ
							6.118		
1958	Gasoline	100.0	Mgal	42	2.38	Mbbls	(GJ/bbl)	15	PJ
			M(kWh)				3.6		
1958	Electric	4275.0	(=GWh)			kWh	TJ/kWh	15	PJ
	Electric		M(kWh)		Fossil Fuel		3.6		
1958	(QC)	4275.0	(=GWh)	2.6	Equiv.	kWh	TJ/kWh	40	PJ
							8.3		
1958	Capital	6993.5	Mdollars	6.8	47237.9	2005	MJ/\$	392	PJ
1958	Capital *	6993.5	Mdollars	6.8	47237.9	2005	14 MJ/\$	661	PJ
1958	Capital	6993.5	Mdollars	6.8	47237.9	2005	20 MJ/\$	945	PJ
1958	TOTLO	-	-	-	-	-	-	1358	PJ
1958	TOTAL *	-	-	-	-	-	-	1628	PJ
1958	TOTQC *	-	-	-	-	-	-	1652	PJ
1958	TOTHIQC	-	-	-	-	-	-	1936	PJ
1963	N. Gas	964.2	Bcf	0.028	26.9976	E9m ³	36	972	PJ
							6.118		
1963	Fuel oil	5.5	Mbbls				(GJ/bbl)	34	PJ
							6.118		
1963	Gasoline	157.6	Mgal	42	3.75	Mbbls	(GJ/bbl)	23	PJ
			M(kWh)				3.6		
1963	Electric	6696.0	(=GWh)			kWh	TJ/kWh	24	PJ
	Electric		M(kWh)		Fossil Fuel		3.6		
1963	(QC)	6696.0	(=GWh)	2.6	Equiv.	kWh	TJ/kWh	63	PJ

Table A-1. Cont.

Year	Type	Original Units			To Metric		Energy		
		Raw value(#)	(M= 10 ⁶)	Conversion	(or other)	Units	Density	Total Energy	Units
1963	Capital	8596.1	Mdollars	6.4	55015.0	2005	8.3 MJ/\$	455	PJ
1963	Capital *	8596.1	Mdollars	6.4	55015.0	2005	14 MJ/\$	768	PJ
1963	Capital	8596.1	Mdollars	6.4	55015.0	2005	20 MJ/\$	1097	PJ
1963	TOTLO	-	-	-	-	-	-	1508	PJ
1963	TOTAL *	-	-	-	-	-	-	1820	PJ
1963	TOTQC *	-	-	-	-	-	-	1859	PJ
1963	TOTHIQC	-	-	-	-	-	-	2188	PJ
1972	N. Gas	1164.0	Bcf	0.028	32.592	E9m ³	36	1173	PJ
							6.118		
1972	Fuel oil	18.9	Mbbls				(GJ/bbl)	115	PJ
							6.118		
1972	Gasoline	122.9	Mgal	42	2.93	Mbbls	(GJ/bbl)	15	PJ
			M(kWh)				3.6		
1972	Electric	14060.0	(=GWh)			kWh	TJ/kWh	51	PJ
	Electric		M(kWh)		Fossil Fuel		3.6		
1972	(QC)	14060.0	(=GWh)	2.6	Equiv.	kWh	TJ/kWh	132	PJ
1972	Capital	12927.2	Mdollars	5.2	67221.4	2005	8.3 MJ/\$	559	PJ
1972	Capital*	12927.2	Mdollars	5.2	67221.4	2005	14 MJ/\$	943	PJ
1972	Capital	12927.2	Mdollars	5.2	67221.4	2005	20 MJ/\$	1347	PJ
1972	TOTLO	-	-	-	-	-	-	1913	PJ
1972	TOTAL *	-	-	-	-	-	-	2297	PJ
1972	TOTQC *	-	-	-	-	-	-	2378	PJ
1972	TOTHIQC	-	-	-	-	-	-	2782	PJ
1977	N. Gas	1382.0	Bcf	0.028	38.696	E9m ³	36	1393	PJ
							6.118		
1977	Fuel oil	33.1	Mbbls				(GJ/bbl)	203	PJ
							6.118		
1977	Gasoline	223.4	Mgal	42	5.32	Mbbls	(GJ/bbl)	33	PJ
			M(kWh)				3.6		
1977	Electric	19679.0	(=GWh)			kWh	TJ/kWh	71	PJ
	Electric		M(kWh)		Fossil Fuel		3.6		
1977	(QC)	19679.0	(=GWh)	2.6	Equiv.	kWh	TJ/kWh	184	PJ
1977	Capital	44638.3	Mdollars	3.2	142842.6	2005	8.3 MJ/\$	1194	PJ
1977	Capital *	44638.3	Mdollars	3.2	142842.6	2005	14 MJ/\$	2013	PJ
1977	Capital	44638.3	Mdollars	3.2	142842.6	2005	20 MJ/\$	2876	PJ
1977	TOTLO	-	-	-	-	-	-	2893	PJ
1977	TOTAL *	-	-	-	-	-	-	3712	PJ
1977	TOTQC *	-	-	-	-	-	-	3826	PJ
1977	TOTHIQC	-	-	-	-	-	-	4688	PJ

Table A-1. Cont.

Year	Type	Raw value(#)	Original Units (M= 10 ⁶)	Conversion	To Metric (or other)	Units	Energy Density	Total Energy	Units
1982	N. Gas	913.0	Bcf	0.028	25.564	E9m ³	36 6.118	920	PJ
1982	Fuel oil	52.6	Mbbbls				(GJ/bbl) 6.118	322	PJ
1982	Gasoline	343.5	Mgal M(kWh)	42	8.18	Mbbbls	(GJ/bbl) 3.6	50	PJ
1982	Electric	34857.0	(=GWh)			kWh	TJ/kWh	125	PJ
1982	Electric (QC)	34857.0	(=GWh)	2.6	Fossil Fuel Equiv.	kWh	3.6 TJ/kWh	326	PJ
1982	Capital	131585.1	Mdollars	2	263170.2	2005	8.3 MJ/\$	2209	PJ
1982	Capital*	131585.1	Mdollars	2	263170.2	2005	14 MJ/\$	3727	PJ
1982	Capital	131585.1	Mdollars	2	263170.2	2005	20 MJ/\$	5324	PJ
1982	TOTLO	-	-	-	-	-	-	3627	PJ
1982	TOTAL*	-	-	-	-	-	-	5144	PJ
1982	TOTQC*	-	-	-	-	-	-	5345	PJ
1982	TOTHIQC	-	-	-	-	-	-	6942	PJ
1987	N. Gas	1011.4	Bcf	0.028	28.31	E9m ³	36 6.118	1019	PJ
1987	Fuel oil	20.8	Mbbbls				(GJ/bbl) 6.118	127	PJ
1987	Gasoline	174.8	Mgal M(kWh)	42	4.16	Mbbbls	(GJ/bbl) 3.6	25	PJ
1987	Electric	28418.0	(=GWh)			kWh	TJ/kWh	102	PJ
1987	Electric (QC)	28418.0	(=GWh)	2.6	Fossil Fuel Equiv.	kWh	3.6 TJ/kWh	266	PJ
1987	Capital	55749.0	Mdollars	1.7	94773	2005	8.3 MJ/\$	795	PJ
1987	Capital*	55749.0	Mdollars	1.7	94773	2005	14 MJ/\$	1342	PJ
1987	Capital	55749.0	Mdollars	1.7	94773	2005	20 MJ/\$	1917	PJ
1987	TOTLO	-	-	-	-	-	-	2069	PJ
1987	TOTAL*	-	-	-	-	-	-	2616	PJ
1987	TOTQC*	-	-	-	-	-	-	2779	PJ
1987	TOTHIQC	-	-	-	-	-	-	3354	PJ
1992	N. Gas	878.0	Bcf	0.028	24.584	E9m ³	36 6.118	885	PJ
1992	Fuel oil	9.6	Mbbbls				(GJ/bbl) 6.118	59	PJ
1992	Gasoline	82.7	Mgal	42	1.97	Mbbbls	(GJ/bbl)	12	PJ

Table A-1. Cont.

Year	Type	Raw value(#)	Original Units (M= 10 ⁶)	Conversion	To Metric (or other)	Units	Energy Density	Total Energy	Units
			M(kWh)				3.6		
1992	Electric	33036.0	(=GWh)			kWh	TJ/kWh	119	PJ
	Electric		M(kWh)		Fossil Fuel		3.6		
1992	(QC)	33036.0	(=GWh)	2.6	Equiv.	kWh	TJ/kWh	309	PJ
1992	Capital	56544.1	Mdollars	1.4	79161.7	2005	8.3 MJ/\$	653	PJ
1992	Capital *	56544.1	Mdollars	1.4	79161.7	2005	14 MJ/\$	1101	PJ
1992	Capital	56544.1	Mdollars	1.4	79161.7	2005	20 MJ/\$	1574	PJ
1992	TOTLO	-	-	-	-	-	-	1728	PJ
1992	TOTAL *	-	-	-	-	-	-	2176	PJ
1992	TOTQC *	-	-	-	-	-	-	2366	PJ
1992	TOTHIQC	-	-	-	-	-	-	2839	PJ
1997	N. Gas	1072.0	Bcf	0.028	30.016	E9m ³	36	1081	PJ
							6.118		
1997	Fuel oil	11.2	Mbbls				(GJ/bbl)	69	PJ
							6.118		
1997	Gasoline	164.0	Mgal	42	3.90	Mbbls	(GJ/bbl)	24	PJ
			M(kWh)				3.6		
1997	Electric	34,339.8	(=GWh)			kWh	TJ/kWh	124	PJ
	Electric		M(kWh)		Fossil Fuel		3.6		
1997	(QC)	34,339.8	(=GWh)	2.6	Equiv.	kWh	TJ/kWh	321	PJ
1997	Capital	74309.0	Mdollars	1.2	89170.8	2005	8.3 MJ/\$	750	PJ
1997	Capital *	74309.0	Mdollars	1.2	89170.8	2005	14 MJ/\$	1265	PJ
1997	Capital	74309.0	Mdollars	1.2	89170.8	2005	20 MJ/\$	1807	PJ
1997	TOTLO	-	-	-	-	-	-	2047	PJ
1997	TOTAL *	-	-	-	-	-	-	2562	PJ
1997	TOTQC*	-	-	-	-	-	-	2759	PJ
1997	TOTHIQC	-	-	-	-	-	-	3302	PJ
2002	N. Gas	876.0	Bcf	0.028	24.528	E9m ³	36	883	PJ
							6.118		
2002	Fuel oil	30.0	Mbbls				(GJ/bbl)	184	PJ
							6.118		
2002	Gasoline	100.0	Mgal	42	2.38	Mbbls	(GJ/bbl)	15	PJ
			M(kWh)				3.6		
2002	Electric	27255.0	(=GWh)			kWh	TJ/kWh	98	PJ
	Electric		M(kWh)		Fossil Fuel		3.6		
2002	(QC)	27255.0	(=GWh)	2.6	Equiv.	kWh	TJ/kWh	255	PJ
2002	Capital	78518.0	Mdollars	1.1	86369.8	2005	8.3 MJ/\$	718	PJ
2002	Capital*	78518.0	Mdollars	1.1	86369.8	2005	14 MJ/\$	1212	PJ
2002	Capital	78518.0	Mdollars	1.1	86369.8	2005	20 MJ/\$	1731	PJ

Table A-1. Cont.

Year	Type	Raw value(#)	Original Units (M= 10 ⁶)	Conversion	To Metric (or other)	Units	Energy Density	Total Energy	Units
2002	TOTLO	-	-	-	-	-	-	1898	PJ
2002	TOTAL*	-	-	-	-	-	-	2391	PJ
2002	TOTQC*	-	-	-	-	-	-	2548	PJ
2002	TOTHIQC	-	-	-	-	-	-	3067	PJ
2007	N. Gas	770.0	Bcf	0.028	21.56	E9m ³	36	776	PJ
							6.118		
2007	Fuel oil	9036.0	Mbbls				(GJ/bbl)	55	PJ
							6.118		
2007	Gasoline	100.0	Mgal	42	2.38	Mbbls	(GJ/bbl)	15	PJ
			M(kWh)				3.6		
2007	Electric	25496.0	(=GWh)			kWh	TJ/kWh	92	PJ
	Electric		M(kWh)		Fossil Fuel		3.6		
2007	(QC)	25496.0	(=GWh)	2.6	Equiv.	kWh	TJ/kWh	239	PJ
2007	Capital	188518.0	Mdollars	0.94	177207	2005	8.3 MJ/\$	1473	PJ
2007	Capital *	188518.0	Mdollars	0.94	177207	2005	14 MJ/\$	2485	PJ
2007	Capital	188518.0	Mdollars	0.94	177207	2005	20 MJ/\$	3550	PJ
2007	TOTLO	-	-	-	-	-	-	2411	PJ
2007	TOTAL *	-	-	-	-	-	-	3423	PJ
2007	TOTQC *	-	-	-	-	-	-	3569	PJ
2007	TOTHIQC	-	-	-	-	-	-	4634	PJ

TOTLO = the total sum of the direct energy plus the lower calculated indirect energy estimate (8.3 MJ) and not electric quality corrected.

Total* = the total sum of direct energy plus the middle value of indirect energy (14 MJ) and not the quality corrected energy value.

TOTQC* = the total sum of direct energy values plus the middle value of indirect energy (14 MJ) and includes quality corrected electric values.

TOTHIQC = the total sum of direct energy values plus the highest calculated indirect energy cost (20 MJ) and includes quality corrected electric values.

© 2011 by the authors; licensee MDPI, Basel, Switzerland. This article is an open access article distributed under the terms and conditions of the Creative Commons Attribution license (<http://creativecommons.org/licenses/by/3.0/>).

Article

Energy Return on Investment for Norwegian Oil and Gas from 1991 to 2008

Leena Grandell ^{1,*}, Charles A.S. Hall ² and Mikael Höök ¹

¹ Department of Physics and Astronomy, Box 353, SE-75121, Uppsala University, Uppsala, Sweden; E-Mail: mikael.hook@fysast.uu.se

² Graduate Program in Environmental Science, College of Environmental Science and Forestry, State University of New York, Syracuse, NY 13210, USA; E-Mail: chall@esf.edu

* Author to whom correspondence should be addressed; E-Mail: grandell@t-online.de; Tel.: +49-6257-5062929.

Received: 28 September 2010; in revised form 15 February 2011 / Accepted: 15 March 2011 /

Published: 26 October 2011

Abstract: Norwegian oil and gas fields are relatively new and of high quality, which has led, during recent decades, to very high profitability both financially and in terms of energy production. One useful measure for profitability is Energy Return on Investment, EROI. Our analysis shows that EROI for Norwegian petroleum production ranged from 44:1 in the early 1990s to a maximum of 59:1 in 1996, to about 40:1 in the latter half of the last decade. To compare globally, only very few, if any, resources show such favorable EROI values as those found in the Norwegian oil and gas sector. However, the declining trend in recent years is most likely due to ageing of the fields whereas varying drilling intensity might have a smaller impact on the net energy gain of the fields. We expect the EROI of Norwegian oil and gas production to deteriorate further as the fields become older. More energy-intensive production techniques will gain in importance.

Keywords: Norwegian oil and gas sector; Energy Return on Investment; net energy

1. Introduction

Oil and gas are the lifeblood of contemporary industrial states, and their economies, and our global population has grown more or less in parallel with increases in the use of oil and gas. New concerns about “peak oil” raise serious questions about the future viability of oil and gas and of the economies

based upon them [1-3]. Perhaps of equal concern is the increasing difficulty in obtaining oil and gas, both in terms of monetary costs and, of particular interest here, energy extraction costs. We need a consistent way of thinking about the meaning of the impacts of these factors on the magnitude of the future availability of various fuels. A critical issue missing from this debate is not how much oil is in the ground, or how much we might be able to extract, but rather how much we can extract with a significant energy surplus. In other words, what we need to know is the net, not gross, energy availability from oil. A second, related issue is the role of technology, which some argue can offset the depletion of easily accessible oil and gas reserves (generally with high EROI and therefore high net energy flows) by advances that allow the exploitation of more technically-challenging resources. But how energy intensive is advanced technology, especially when applied to challenging environments, and how does it affect net energy gain? Can the net energy gain from unconventional fields ever realistically offset the losses caused by depletion in conventional production?

The increasing energy cost of getting energy is perhaps best expressed as EROI (energy return on (energy) invested). EROI analysis offers a useful approach for looking at the advantages and disadvantages of a given fuel, its changes over time, and offers the possibility of looking into the future in a way that markets seem unable to do. Its advocates also believe that, in time, market prices must approximately reflect comprehensive EROIs, if appropriate corrections for quality are made and subsidies removed. Nevertheless we hasten to add that we do not believe that EROI by itself is necessarily a sufficient criterion by which judgments might be made, although it is the one we favor the most, especially when it indicates that one fuel has a much higher or lower EROI than others. In addition it is important to consider the present and future magnitude of the fuel, and how EROI might change if the use of a fuel is expanded. These concerns are developed in various ways in a series of older and recent papers that we and others have produced and that are reflected in this study [4-9].

The North Sea oil fields, discovered in the 1960s, represent one of the few major global oil developments in recent decades. There are about 400 fields in the North Sea, most producing oil, gas condensate and natural gas liquids. Collectively, these products are called petroleum. The overwhelming majority of the volume of North Sea oil is in the United Kingdom and Norway, with small amounts in Denmark and the Netherlands. Some fields are quite large. In Norway (Figure 1), for example, there are a total of 22 fields each containing over 500 million barrels of original recoverable resources (Table 1). Likewise, in England there are a number of very large fields such as Brent and the Forties. The large fields were developed first and were extremely profitable. As of 2010, Norway is still reaping enormous financial profits from these fields but the production in both the English and Norwegian sectors has clearly peaked (for oil in 1999 and 2000 respectively, and now in terms of all energy production). These fields saved England from serious economic decline in the 1980s. The recent decline in production has been a serious contributor to the recent difficult economic and political conditions of the UK. The oil transformed Norway from a poor country to a wealthy one, especially since there are far fewer people in Norway to share the oil wealth. It is important to judge the past, present and future of these oil fields in both economic terms and in terms of their ability to provide net energy to their respective countries [12].

Figure 1. Norwegian Petroleum production area consisting of the Barents Sea, Norwegian Sea and North Sea [13].

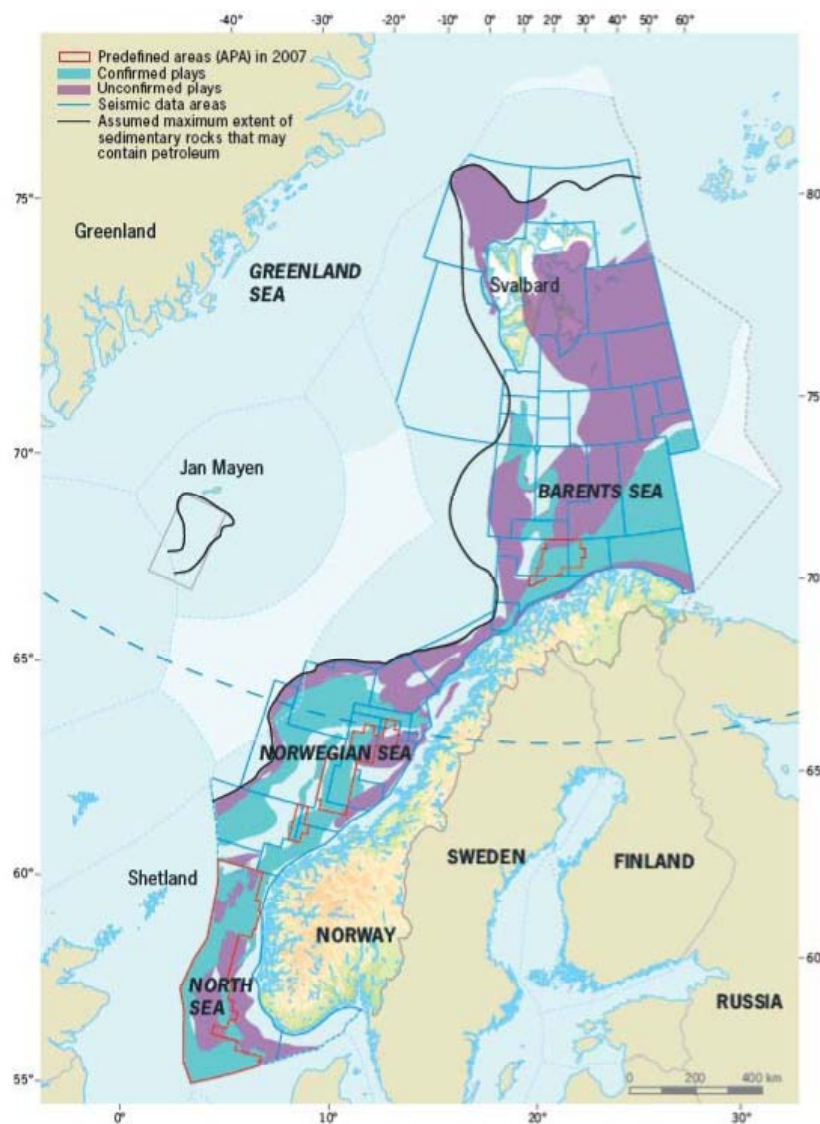

Table 1. Norwegian fields containing over 500 million barrels of original recoverable resources [14]. Original recoverable resources refer to technically recoverable quantities of petroleum before production takes place. Scm o.e. (oil equivalents) means standard cubic meters oil equivalent and is equivalent to 6.29 barrels of oil.

Name of the field	Resources (mill. scm o.e.)	Resources (mill. Barrels)	Name of the field	Resources (mill. scm o.e.)	Resources (mill. Barrels)
Draugen	149	938	Oseberg	491	3089
Ekofisk	712	4479	Sleipner Vest	163	1023
Eldfisk	186	1171	Sleipner øst	120	753
Frigg	117	734	Snorre	250	1570
Grane	116	731	Snøhvit	191	1199

Table 1. Cont.

Name of the field	Resources (mill. scm o.e.)	Resources (mill. Barrels)	Name of the field	Resources (mill. scm o.e.)	Resources (mill. Barrels)
Gullfaks	390	2453	Statfjord	688	4324
Gullfaks Sør	105	662	Troll	1626	10225
Heidrun	231	1452	Ula	97	613
Kvitebjørn	107	674	Valhall	181	1141
Norne	109	686	Visund	88	552
Ormen Lange	423	2662	Åsgard	368	2315

2. EROI

EROI is a tool used in net analysis. EROI is a simple but powerful way to examine the quality of an energy resource. What really matters to our economies is the net energy flow (not the gross) provided by our energy sector and this can be estimated through the EROI approach. EROI is calculated from the following simple equation, although the devil is in the details [6,15]:

$$\text{EROI} = \frac{\text{Energy returned to society}}{\text{Energy required to get that energy}} \quad (1)$$

Sometimes this equation is applied to *finding* energy, sometimes for *producing* it, and most usually and appropriately for both. It should not be used for computing the efficiency of, for example, going from crude oil to gasoline.

Getting values for the numerator is usually easy enough, at least in open societies. Estimates of the fuel produced, usually given in barrels or cubic feet, are multiplied by approximate energy values for that fuel (approximately 6.1 GJ per barrel of oil and 36 GJ per cubic meter of natural gas depending on the characteristics of the fuels).

Generating values for the denominator is usually difficult. The United States and the United Kingdom maintain official public records on the energy use of various sectors of the economy, including the oil and gas industry. These values are published approximately every five years. Data quality is often good. They apply to the entire national industry so it is difficult to see what they might be for particular projects. Brandt [9] has undertaken analyses for specific oil fields in California, but such analyses are rare. Table 2 is a summary of all EROIs for oil and gas that we are aware of. In general, the EROI for extraction of oil and gas for the United States has been decreasing from probably very high, although estimates in the early part of the last century are poorly known, to about 30:1 in the middle of the last century to roughly 10:1 or less today. This pattern is complicated by the tendency of EROIs to increase and decline in a pattern opposite to drilling intensity—in other words, doubling drilling intensity approximately halves the EROI value relative to the secular trend [4,16]. Global values have tended to be about twice as high as US values but are declining similarly [8].

Table 2. Summary of Energy Return on Investment (EROI) analysis for oil and gas. Values are for the United States unless otherwise noted. Note that the value of 100:1 for 1930 was for finding oil, not producing it. New values for production are produced in this volume [17].

Resource	Year	EROI	Reference
<i>US Oil and Gas Discoveries</i>			
Oil and gas	1930	>100:1	[18]
Oil and gas	1970	8:1	[6]
Oil and gas	2000	5:1	[17]
<i>US Oil and Gas Production</i>			
Oil and gas	1970	30:1	[6]
Oil and gas	1980	20:1	[6]
Oil and gas	2000	11–18:1	[18]
Oil and Gas	2005	10:1	[17]
<i>World oil and gas production</i>			
	1990s	35:1	[8]
	2006	18:1	[8]
<i>California oil fields</i>			
	1980	12:1	[9]
	2010	3:1 to 5:1	[9]

One would think that there would be a good database detailing the energy cost of all of the energy we exploit, since it seems very important to examine this process over time. One might even imagine that such data might be amongst the most important information our entire civilization needs to know. Unfortunately this is not the case, as there are only a few countries that maintain the raw data and make it public, let alone analyze EROI or insure quality control. In addition, there are large economic vested interests and political constituencies who argue that market prices alone are the best way to evaluate and rank fuels, and that scientific analyses undermine the “wisdom of the market”. An even larger problem is that a large proportion (roughly half globally) of oil is produced by national oil companies (NOCs), which show little interest in making any of their information public or having it audited. What we do have is:

- Reasonably good data for the United States (but with declining comprehensiveness and perhaps quality), which has maintained for many years statistics on the energy used by all major industries, including oil and gas [19-22].
- Similar data for the United Kingdom for a less extended period of time [23,24].
- A fairly good database on dollar costs for a large majority of publicly traded oil and gas companies maintained by John S. Herold Incorporated (now IHS) [25]. In a previous paper we were able to derive energy intensities per dollar spent for the U.S. and the U.K. [8]. We combined these with the Herold data to estimate global energy costs of oil and gas extraction.

It would be useful to derive estimates from specific oil and gas fields to examine their EROI against the aggregate national values discussed above. We could also use this analysis to examine the impact of technology *vs.* that of depletion. While we do not know how either effect can be derived independently, their combined impact can be estimated by the time trend in EROI. In other words, there is a sort of “race” in which technological advancement is in constant contention with depletion.

The question of which is “winning” cannot be answered theoretically, but must be addressed empirically [26, 27]. We do this by assessing the time trends in the efficiency (*i.e.*, EROI) with which we produce oil and gas. We need to know how much energy is returned to society in the form of oil and gas compared to that which is invested by the industry in getting it, and how that ratio is changing over time. If the energy return on that invested by the industry is increasing over time, then we would have evidence that new technologies are currently outpacing depletion, and vice versa. The rate of change of EROI may also give us some indication of how close we are to the critical point at which it takes as much energy to extract the resource as we gain through its production [7, 28]. Hence we use as our working hypothesis that the EROI of Norwegian oil and gas is declining. If this were true, it would indicate that depletion is more important than technological advancement in the Norwegian oil and gas industry, at least so far.

3. Methods

We use equation 2 to estimate the EROI of Norwegian oil and gas over the period of their production. The sum total of energy inputs and outputs over the life of most oil and gas fields is unknown simply because most oil and gas fields are still in production. For this reason we use a annual average calculation of EROI, that is, we divide energy output of the Norwegian oil and gas industry (E_o , in MJ) in a given year by the energy input to the oil and gas extraction industry for that same year (E_i , in MJ). Hence:

$$EROI = E_o/E_i \quad (2)$$

Where all terms are for a particular year, or more usually for a series of years.

3.1. Energy Outputs

Calculating energy output is easy because of the availability and organization of the data in national data base. We calculated the energy output of all petroleum components (oil, gas, condensate, NGL) from all oil and gas fields based on raw data supplied by the Norwegian Petroleum Directorate, NPD [29]. Norway shares three fields with Great Britain, namely Statfjord, Frigg and Murchison. The figures provided by NPD take into account only the Norwegian share of the production of these fields, plus all other fields in the territorial boundaries of Norway. Figure 2 shows the production from the very beginning of production in 1971 to 2008. An example of that data for the peak production year (2000) is given in Table 3. Table 4 gives estimates of the energy value of these data and the conversions used.

Table 3. Norwegian petroleum production in 2000 with natural gas, condensate, and NGL given as oil equivalent [29].

		Mtoe	mill. barrel	EJ
Oil	181.2 mill. scm	152.2	1139.6	6.4
Gas	49.7 bill. scm	41.8	312.9	1.7
Condensate	6.3 mill. scm	5.3	39.5	0.2
NGL	7.2 mill. scm	6.1	45.4	0.3

Table 4. All energy units used. Energy conversion factors used for diesel. 1 scm o.e. (oil equivalents) is equal to 0,84 toe.

Energy carrier	Conversion factor
Oil	1 scm = 1 scm o.e.
Gas	1000 scm = 1 scm o.e.
Condensate	1 scm = 1 scm o.e.
NGL	1 scm = 1 scm o.e.
Diesel:	
Density	0.845 t/m ³
Energy density (per mass)	42.8 GJ/t
Energy density (per volume)	0.864 toe /1000 liters

3.2. Energy Inputs

There are various categories of energy inputs and each requires different means of estimating their value [30]:

- (1) *Direct energy* is that used on the site to operate, for example, a seismic survey, turn a rotary bit, pump or pressurize a field, operate maintenance vehicles and so on. The data is usually derived from direct statistics on the site;
- (2) *Indirect energy* (or embodied energy) is used to make the materials used on site: for example steel forms, cement, vehicles and so on. There is generally little debate about the appropriateness of including direct and indirect energies (even though the question related to the boundaries of the analysis is more controversial). The other categories are more controversial but can include:
- (3) The energy cost of providing labor [28];
- (4) The energy cost of the energy required to build the infrastructure to use the energy in question (*i.e.*, a truck or highway) [15], and;
- (5) The energy cost of compensating for environmental damage.
- (6) The energy cost of financial services.

While we believe that these other categories (3–5) are very important we leave their discussion and consideration to other papers in this special issue [30] and elsewhere [7,31].

By relying on the data by Norwegian Petroleum Directory and Statistics Norway (values for both the direct energy consumption on site and also monetary values for various other categories, such as capital equipment expenditure and fuel expenditure), we were able to derive comprehensive, if somewhat imprecise, estimates of total energy used. Our EROI calculation in this paper is consistent with the standard EROI suggested by Murphy and Hall [30]. It refers to the energy cost and therefore the EROI value at the well head. According to Statistics Norway pipeline transport leads to additional energy costs adding approximately 5–10% to the direct energy costs at well head [32]. Thus EROI calculated on shore would be accordingly smaller.

Figure 2. Norwegian petroleum production 1971–2008 [29]. Scm = Standard cubic meters (volume) and Mtoe = million tons oil energy equivalent. 1 scm o.e. = 0.84 toe. NGL = Natural gas liquids and Cond. = “lease Condensate”, a petroleum liquid derived from Natural gas on site. See Table 4 for energy densities and conversions used.

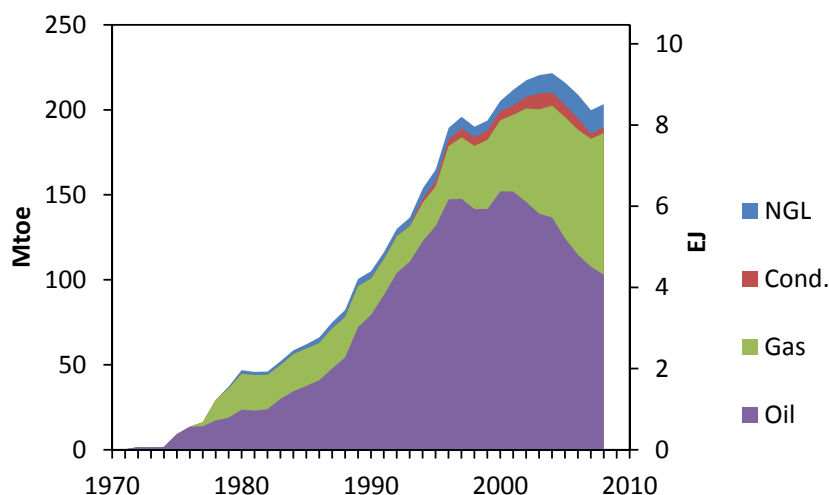

3.3. On-Site Energy

Normally, energy companies use natural gas as much as possible in the fields since oil is more valuable and gas is more difficult to transport. We were able to derive energy inputs used on-site (*i.e.*, at the platforms) from two different sources:

- (1) The first energy input is fuel consumed for all other aspects of petroleum production except drilling. We obtained detailed field-by-field consumption figures for gas (in scm, standard cubic meters) beginning in 1974 and for diesel (in liters) beginning in 1994. Additionally, we received aggregate diesel consumption figures for the years 1991–1993 [33]. The data covers only the fuel consumed for petroleum production (*i.e.*, energy used to pump products or pressurize fields) but not the energy consumed in drilling. The data is compiled by the Norwegian Petroleum Directorate. An example of the data for Troll area is given in Table 5. We estimated the Norwegian share of the diesel and gas consumed for the border fields (Statfjord, Frigg and Murchison) based on the ratio of Norwegian to British plus Norwegian petroleum production figures at these particular fields. The Norwegian oil and gas production figures were obtained from NPD [29]. The British production figures for the three border fields were obtained from the so called “Brown Book” in the case of Frigg [34] and for Murchison and Statfjord from the UK Department of Energy and Climate Change [35] (years 1980–2008). Table 4 includes conversion factors to convert all values to toe.
- (2) Energy used to drill wells. The NPD data base provides the fuel consumption for petroleum production, but not the energy used to drill wells. Thus we need to know the direct fuel consumption for both exploratory and production drilling activities.

Statistical Bureaus usually publish energy consumption figures for various industrial sectors. Unfortunately, in the case of Norway the oil and gas sector is not included in the industrial energy statistics. However, Statistics Norway publishes very detailed data on investments in the oil and gas sector, including direct fuel consumption for drilling purposes, in monetary terms [36,37]. It is divided into three sections (exploration, field development and fields on stream) and each section covers investments for services, drilling and commodities (Table 6). Fuels are covered under “commodities”. We divided monetary investments for fuels by average fuel prices paid by Norwegian industry (Figure 3) to give fuel consumption for drilling in physical units (Figure 4). The average fuel prices were obtained from Statistics Norway [38]. We used the price for light heating oil in our calculations since we assume the fuel used to be largely diesel oil. The values obtained this way might be underestimating the actual fuel consumption for drilling because the oil and gas industry obtains fuel for a lower price than the average price paid by the Norwegian industry. Table 6 gives a summary of the various categories of investment data for exploration and an example of our calculations for the year 2000.

Figure 5 comprises all direct fuel consumption of the Norwegian oil and gas sector including both fuels used for production and fuels used for drilling.

Table 5. Example of the energy consumption data (Troll area) and our conversion to TJ.
See Table 1 for large Norwegian oil and gas fields.

	Gas (1000 scm)	Diesel (1000 litres)	Gas (TJ)	Diesel (TJ)	Total (TJ)
1990	18349		645.3		645.3
1991	36756		1292.7		1292.7
1992	55056		1936.3		1936.3
1993	43700		1536.9		1536.9
1994	43548		1531.5		1531.5
1995	51746	3550	1819.9	128.4	1948.3
1996	109269	3751.8	3842.9	135.7	3978.6
1997	105746	2143.5	3719.0	77.5	3796.5
1998	122023	924.9	4291.4	33.5	4324.9
1999	121310	8916.8	4266.4	322.5	4588.9
2000	195737	7326.9	6883.9	265.0	7148.9
2001	227755	4350	8009.9	157.3	8167.3
2002	217916	1984.4	7663.9	71.8	7735.7
2003	239543	7486.1	8424.5	270.7	8695.3
2004	277539	7180	9760.8	259.7	10020.5
2005	272352	988	9578.4	35.7	9614.1
2006	263025	3835.4	9250.3	138.7	9389.1
2007	272116	2099	9570.1	75.9	9646.0
2008	261909	4447	9211.1	160.8	9371.9

Table 6. Example of the investment data in the Norwegian oil and gas sector consisting of exploration investments for the year 2000 [36]. Energy intensities (4.01 MJ/US\$) were used to calculate the indirect energy associated with the monetary costs. Investment for direct fuel consumption for drilling was converted into energy by using average fuel prices paid by the Norwegian industry (0.27703 NOK/kWh which equals to 76.95 NOK/GJ in the year 2000 for light heating oil).

Category	Expenditures	Expenditures (inflation corrected)	Direct fuel consumption	Indirect energy
	<i>Mill. NOK</i>	<i>Mill. 2005 NOK (Mill. 2005 US\$)</i>	<i>TJ</i>	<i>TJ</i>
General Exploration	608	663 (103)	-	413
Geology/geophysics	269			
Seismic	289			
Special studies	50			
Field evaluation/field development	631	688 (107)	-	429
Field evaluation	140			
Field development	489			
Industrial technology development	1			
Environmental studies	1			
Administration and other costs	923	1007 (156)	-	626
License	126			
administration	307			
Other administration	476			
Area fee	15			
Nifo/Nofo	-			
Environment taxes;				
Other taxes and duties				
Exploration drilling	3110	3393 (526)	1170	2113
<i>Drilling rigs</i>	<i>1089</i>	<i>1188 (184)</i>	-	739
Hire of drilling rigs	955			
Other drilling costs	134			
<i>Transport costs</i>	<i>265</i>	<i>289 (45)</i>	-	180
Helicopters and airplanes	68			
Vessels	197			
<i>Commodities</i>	<i>327</i>	<i>357 (55)</i>	1170	222
Lines, wellheads, drill bits <i>etc.</i>	92	100 (16)	-	62
Cement	20	22 (3.4)	-	14
Drilling mud	71	77 (12)	-	48
Fuel	90	-	1170	-
Use of machinery and equipment	37	40 (6)	-	25

Table 6. Cont.

Category	Expenditures	Expenditures (inflation corrected)	Direct fuel consumption	Indirect energy
Smaller equipment	18	20 (3)	-	12
Technical services	1433	1563 (243)	-	972
Clearing	26			
Cement services	20			
Drilling mud services	25			
Logging	143			
Testing	15			
Diving	21			
Costs, on shore bases	136			
Other technical services	1046			
TOTAL	5272	5751 (892)	1170	3581

Figure 3. Average fuel prices (light heating oil) paid by the Norwegian industry [38].

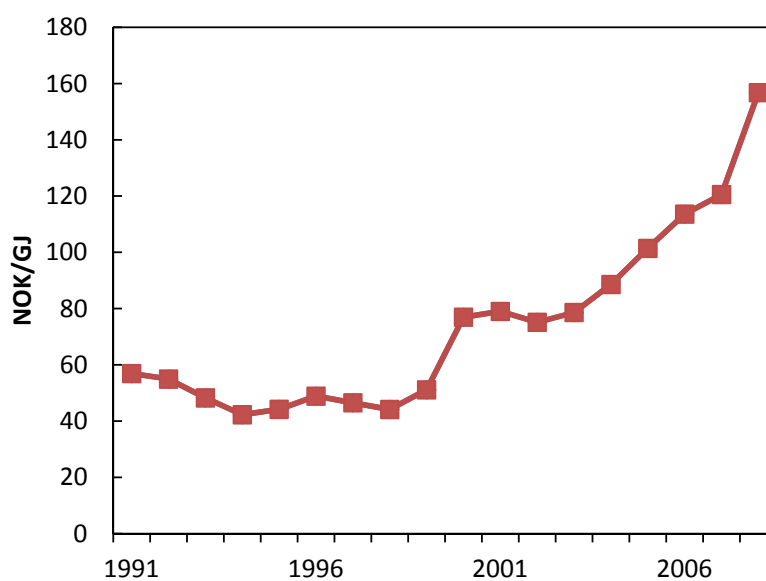

Figure 4. Calculated fuel consumption for drilling based on investment data and average fuel prices. The bottom line is fuel consumption for exploration drilling, added with fuel consumption for production drilling. The sum of these two values gives total fuel consumption for drilling (for example 67 ktce in 1991).

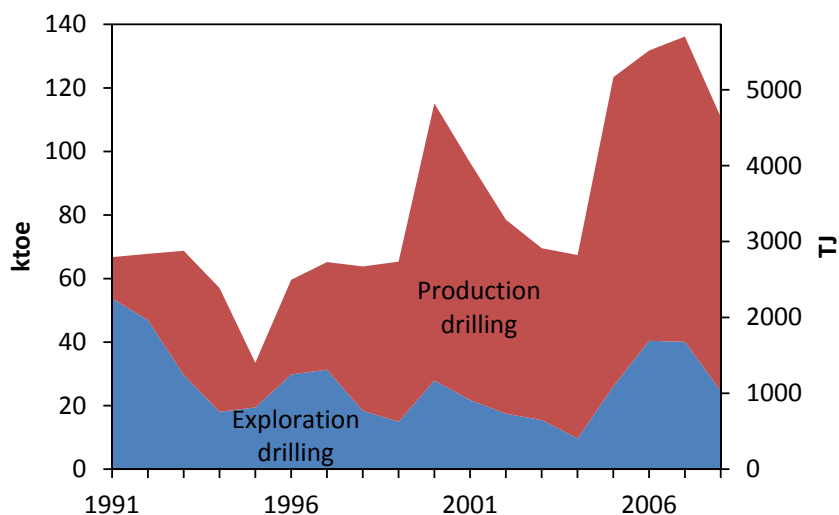
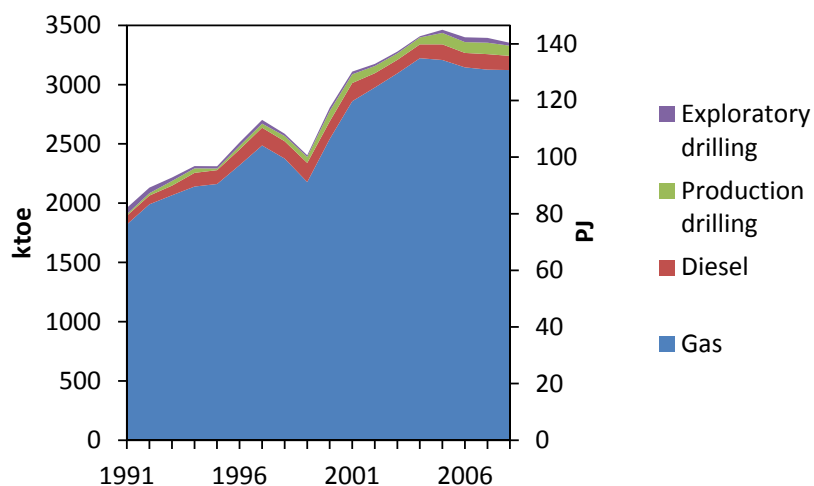

Figure 5. Direct (on platform) diesel and gas consumption for petroleum production and fuel consumption for exploratory and production drilling in Norway.



3.4. Indirect Energy

The calculation of indirect energy is an attempt to estimate the energy consumption of materials, services *etc.* related to petroleum production by deriving the energy intensity (energy used per dollar or Krone) of an activity for which there is financial data. An estimate (4.01MJ/\$) for the energy intensity of the Norwegian economy as a whole was calculated as follows: the Norwegian GDP (according to

current prices) [39] was inflation adjusted to 2005 using CPI [40]. Data on the Norwegian GDP is presented in Figure 6.

Figure 6. GDP of the Norwegian economy in nominal and real terms.

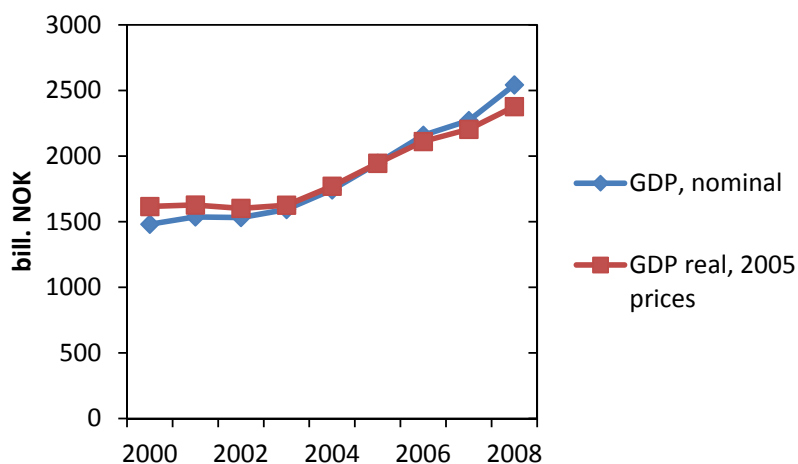

The GDP (in 2005 NOK) was converted to US\$ according to the exchange rate from the year 2005 (6.445 NOK/US\$). The primary energy consumption of the Norwegian economy (excluding natural gas for flaring) was divided by this dollar value for each year to give the average energy use associated with each dollar spent for the country as a whole and all expenditures [41]. Primary energy consumption can be found in Figure 7 and the calculated energy intensity of the Norwegian economy in Figure 8.

Figure 7. Primary energy consumption (excluding natural gas for flaring) of the Norwegian economy [41].

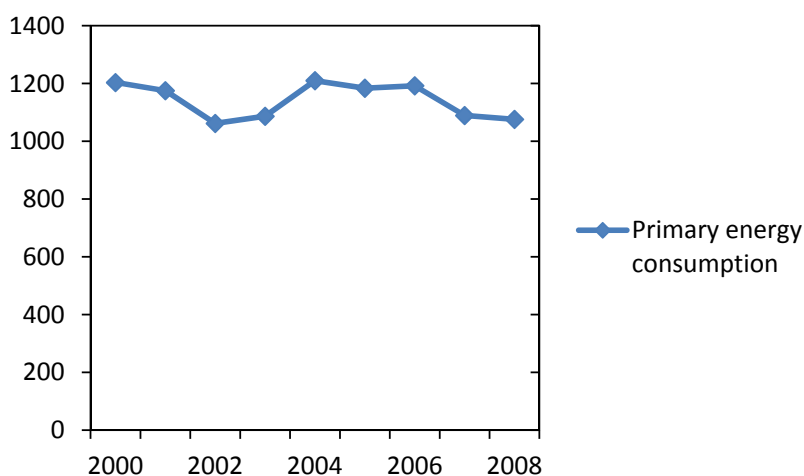

The energy intensity calculation was done for 2000–2008. The result varies between 2.9–4.8 MJ/US\$ with an average of 4.01 MJ/ US\$. The energy intensity of the Norwegian economy declined by 39% over this time period.

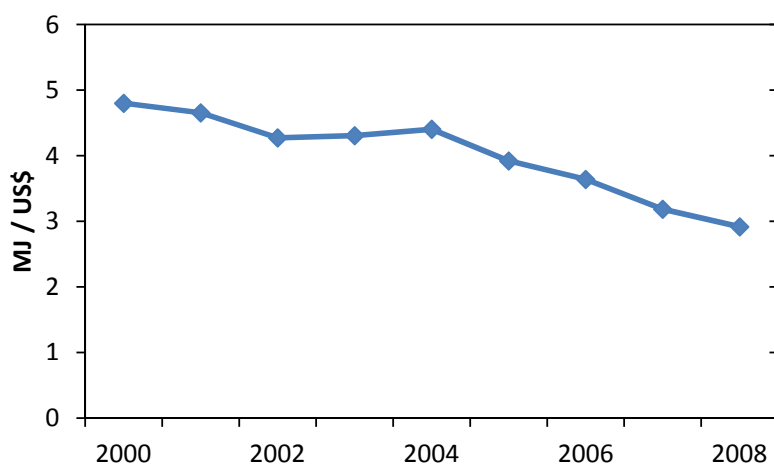
Figure 8. Energy intensity of the Norwegian economy.

Estimates for the indirect energy associated with the purchases by the petroleum sector were derived based on comprehensive investment data provided by Statistics Norway [36,37]. The statistics give detailed information on commodities, services, administrative costs and drilling activities. We excluded the investments needed for fuel (which we had calculated independently). The costs given in current value were inflation-adjusted to 2005 and converted to US dollars (6.445 NOK/US\$, average exchange rate for 2005). Table 6 gives a summary of the various categories of investment data for exploration and an example of our calculations for the year 2000. Figure 9 shows the indirect energy for the whole oil and gas sector for the time period 1991–2008. Figure 10 adds all energy components (both direct and indirect also called embodied energy) together.

Figure 9. Estimates of the indirect energy associated with the purchases of the Norwegian petroleum sector based on the estimate of energy intensity for the Norwegian economy (4.01 MJ/US\$).

Figure 10. Energy consumption of the Norwegian petroleum sector including direct and indirect components.



4. Data Quality Checks

We were able to derive three independent estimates of year-to-year total effort: dollars invested, direct energy invested and feet drilled [29]. Investment data allows us to separate various investments for drilling purposes (including both exploratory *and* production drilling) and other investments. We received data on fuel consumption for petroleum production (excluding production drilling) and we were able to develop estimates for fuel consumption for drilling purposes (including both exploratory and production drilling) based on investments in fuels and average fuel prices. There was a general correlation between drilling activity (measured in drilled km) and monetary investments for drilling, as well as between fuel consumption for drilling and investments for drilling. A modest correlation was found between drilling activity and drilling fuel consumption (Figures 11–13).

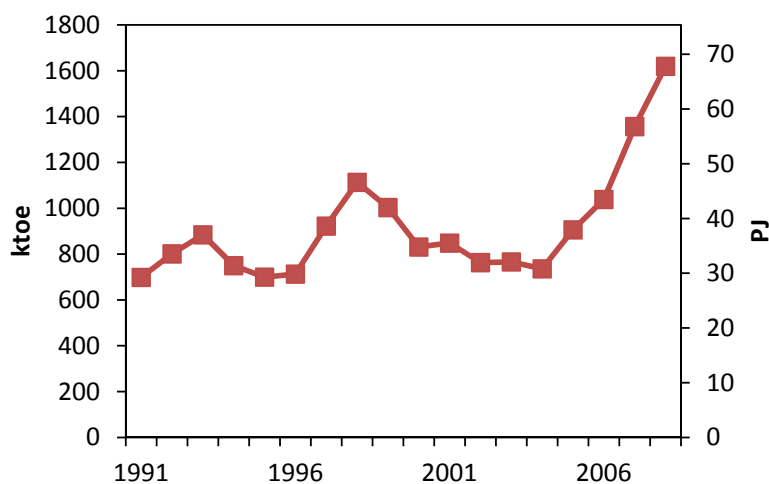
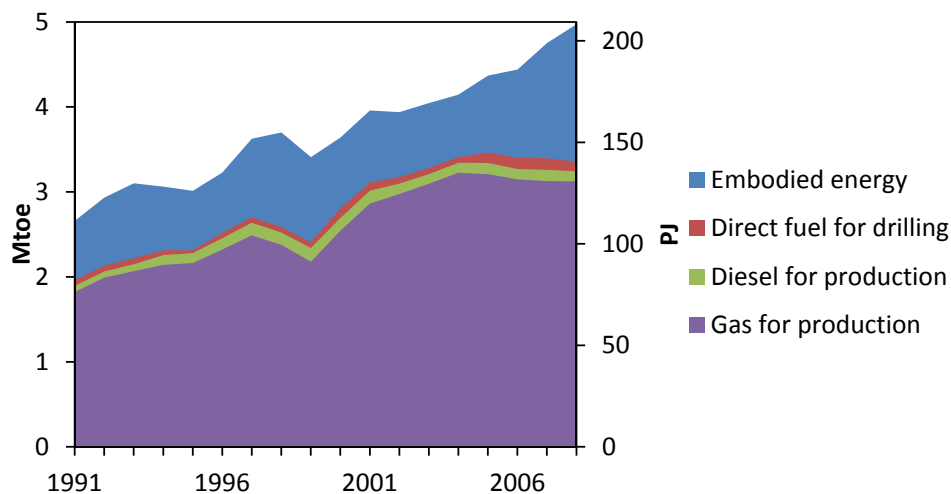
Figure 11. Correlation between drilling activity and drilling fuel consumption. Both exploratory drilling as well as production drilling is included in the figures. $R^2 = 0.55$.

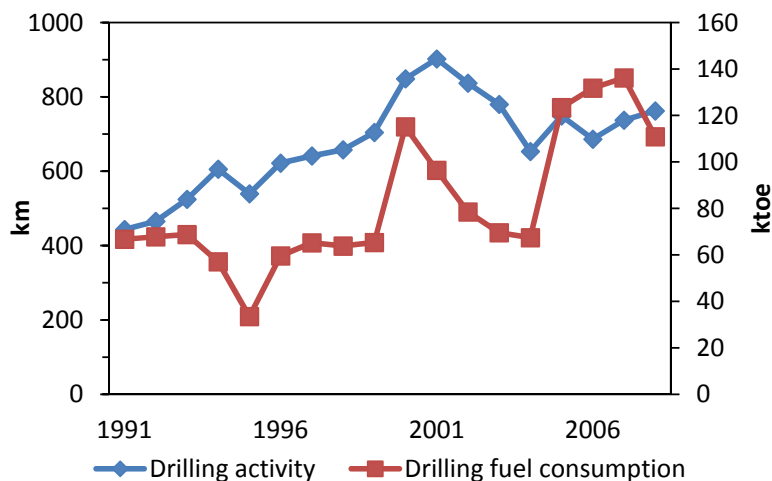

Figure 12. Correlation between drilling fuel consumption and drilling investment. Both exploratory and production drilling are included. $R^2 = 0.83$.

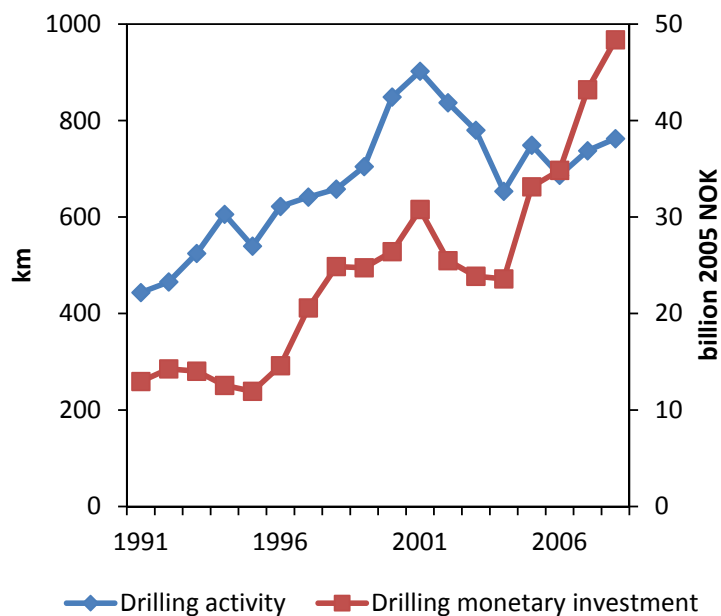
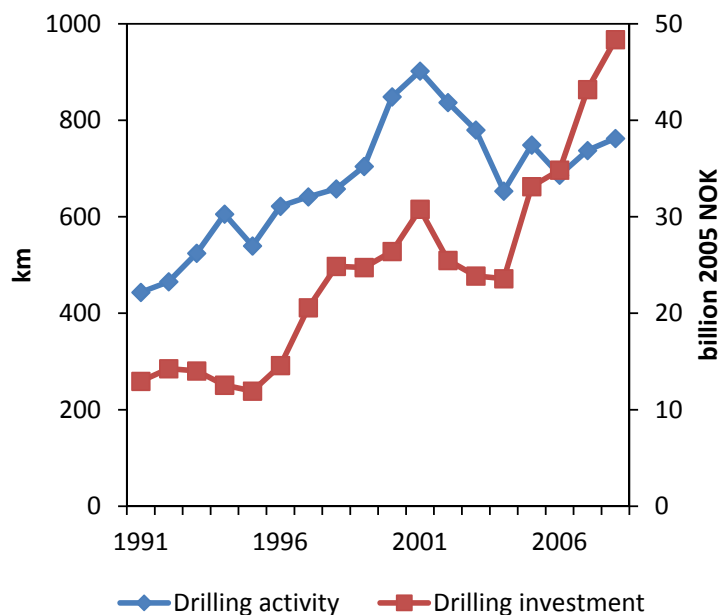

Figure 13. Correlation between drilling activity and drilling investment. Both exploratory and production drilling are included. $R^2 = 0.66$.



5. Results

We found that the energy return on energy Investment (EROI) for Norwegian petroleum production ranged from 44:1 in the early 1990s to a maximum of 59:1 in 1996, to about 40:1 in the latter half of last decade (Figure 14). The curve basically follows, and is dependent upon, the pattern of production over time (peak in oil production was in 2000 and peak in total petroleum production was in 2004). Approximately 74% of the energy cost is due to direct fuel consumption in production (*i.e.*, pressurizing fields, lifting oil and so on), 2% is due to direct fuel consumption for drilling (including both exploratory and production drilling). The remaining 24% of energy cost is energy used indirectly in generating the needed infrastructure and services.

Figure 14. EROI of the Norwegian petroleum production and of oil production only.

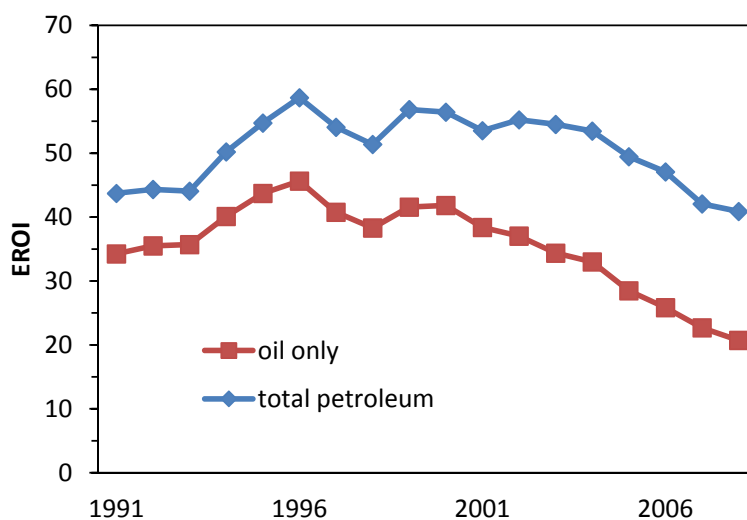

EROI values for oil alone varied from 46:1 in 1996 to around 20:1 in recent years (Figure 14). In terms of production, these values only take oil into account (they exclude gas, NGL and condensate). On the consumption side, however, it covers the whole energy consumption of the petroleum industry.

6. Discussion

These EROI values for Norwegian oil and gas reflect the very high quality of the North Sea oil fields, their high profitability, their newness and the impact of the high level of technology and human skills used. There are very few, if any, oil and gas resources today with such a favorable EROI. However, if the current rate of decline in EROI continues it will reach very low values in a relatively few decades. Like all petroleum-based wealth, Norway's present high living standard is likely to be a passing phenomenon, unless the country's wealth is prudently invested, financially and physically.

What are the reasons for the decline in the EROI estimates, especially since 1999? Probably the most important factor is that it appears that depletion is a somewhat more powerful force than technological improvement. A second effect is that of drilling intensity presented in Figure 15. Previous studies have shown that exploitation efficiency in the petroleum industry declines when exploitation intensity increases [4,16]. The integrated effects of depletion and variable drilling effort

may also explain much of the variability in both the US and the global data. This data shows both a general secular decline over the entire period analyzed and a flattening or even an increase in EROI during periods of reduced drilling effort and a reduction during times of intense drilling.

Figure 15. Drilling activity (measured in drilled km) and EROI of the Norwegian oil and gas industry.

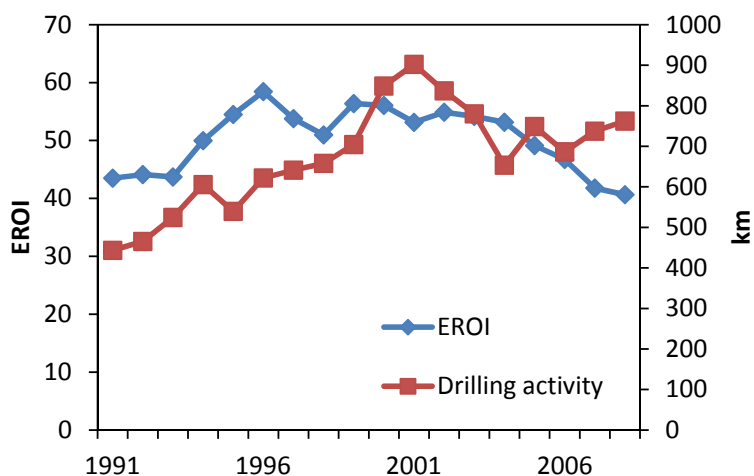

When looking closer at the Norwegian data, it seems that changes in EROI are mostly due to field age. However changes in drilling activity could also have a small impact on the calculated EROI values. Linear curves fitted to the data (Figure 16) show that, since 2003, years with higher drilling activity lead to a slightly lower value of EROI whereas years with higher drilling activity lead to somewhat lower values of EROI.

The overwhelming share of the energy expenditures in the oil and gas sector is due to production (Figure 10). Drilling activity uses only 2–4% of total direct fuel consumption of the industry. However, 23–54% of investments are caused by drilling activity, which means that a similar share of the indirect energy can be attributed to drilling. This way the share of drilling activity in the total energy cost (both direct and embodied energy) of the sector varies between 7–17%.

Between 1999 and 2001 there was an almost 30% increase in drilling activity and, in the same timeframe, a small decline in EROI. This increased drilling intensity may be the cause of a decline in EROI, and may not result in as much additional net energy delivered to society as would initially seem to be the case. The subsequent decline in drilling activity in 2001 to 2004 may have helped the EROI to increase again. Since 2003, the drilling activity has been oscillating between 700 and 800 km annually whereas EROI declined steadily by 25% from 2003 to 2008. It is most likely that this decline was caused by field depletion and it may continue as the Norwegian oil and gas fields continue to age [12]. A recent announcement by the Norwegian Petroleum Directory to enhance recovery in mature fields [42] could further deteriorate EROI of the Norwegian oil and gas production, since it requires often very energy intensive techniques such as nitrogen or CO₂ injection.

Figure 16. EROI of the Norwegian oil and gas production. Blue color refers to years with high drilling activity (over 700 km drilled annually) and brown color refers to years of low drilling activity (600–700 drilled km annually). Linear curves are fitted to the data based on the method of least squares.

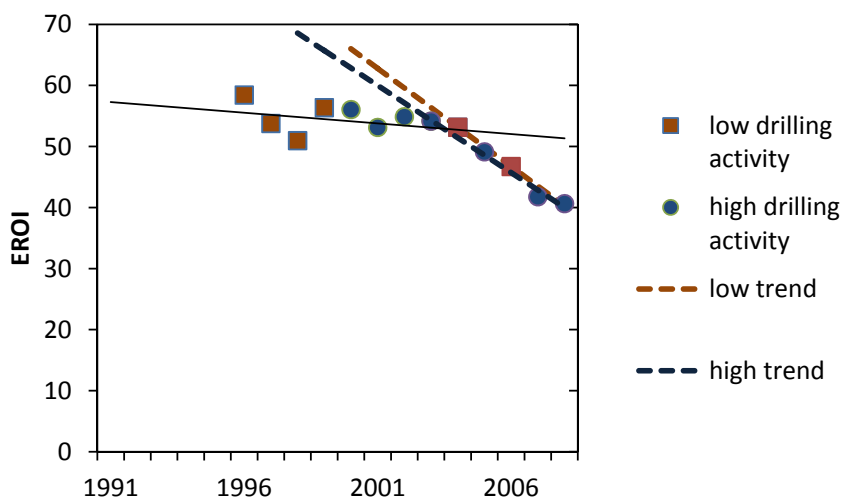

Acknowledgements

We appreciate the support of the Santa-Barbara Family Foundation and of ASPO USA, without which this work would not have been possible. We are very grateful to several experts at Norwegian Petroleum Directorate and Statistics Norway, who provided us very helpful unpublished data on on-site fuel consumption (Rune Hult, NPD), investments (Ståle Mæland, Statistics Norway) and average energy prices paid by Norwegian industry (Sadina Jama, Statistics Norway). Two anonymous reviewers have provided valuable comments and have thus helped in the process of writing this analysis.

References and Notes

1. Campbell, C.J.; Laherrere, J.H. The end of cheap oil. *Sci. Am.* **1998**, *March*, 78-83.
2. *Statistical Review of World Energy*; BP Global: London, UK, 2007.
3. ASPO. Available online: <http://www.peakoil.net/> (accessed on 10th of January 2010).
4. Hall, C.A.S.; Cleveland, C.J. Petroleum drilling and production in the United States: Yield per effort and net energy analysis. *Science* **1981**, *211*, 576-579.
5. Cleveland, C.; Costanza, R.; Hall, C.A.S.; Kaufmann, R.K. Energy and the U.S. economy: A biophysical perspective. *Science* **1984**, *225*, 890-897.
6. Hall, C.A.S.; Cleveland, C.; Kaufmann, R.K. *Energy and Resource Quality: The Ecology of the Economic Process*; Wiley: New York, NY, USA, 1986; p. 577.
7. Hall, C.A.S.; Day, J.W. Revisiting the limits to growth after peak oil. *Am. Sci.* **2009**, *97*, 230-237.
8. Gagnon, N.; Hall, C.A.S.; Brinker, L. A preliminary investigation of energy return on energy investment for global oil and gas production. *Energies* **2009**, *2*, 490-503.

Sustainability **2011**, *3*

9. Brandt, A. Oil depletion and the energy efficiency of oil production: The case of California. *Sustainability* **2011**, *3*, 1833-1854.
10. Munasinghe, M. The sustainomics trans-disciplinary meta-framework for making development more sustainable. Applications to energy issues. *Int. J. Sustain. Dev.* **2002**, *5*, 125-182.
11. Lynch, M.C. The new pessimism about petroleum resources: Debunking the Hubbert model (and Hubbert Modelers). *Miner. Energy* **2003**, *18*, 21-32.
12. Höök, M.; Aleklett, K. A decline rate study of Norwegian oil production. *Energy Policy* **2008**, *36*, 4262-4271.
13. Sørenes T. Energy scenarios for a sustainable future. The Norwegian Continental Shelf. Presented at Energy Scenarios conference, Stockholm, Sweden, 22 October 2009.
14. *Facts, The Norwegian Petroleum Sector 2009*; Nordvik, F.M., Moen, T., Zenker, E., Eds.; Ministry of Petroleum and Energy, Norwegian Petroleum Directorate, Norway, 2009. Available online: <http://www.npd.no/en/Publications/Facts/Facts-2009/> (accessed 14 January 2010).
15. Hall, C.A.S.; Balogh, S.; Murphy, D.J. What is the minimum EROI that a sustainable society must have? *Energies* **2009**, *2*, 25-47.
16. Davis, W. A study of the future productive capacity and probably reserves of the US. *Oil Gas J.* **1958**, *56*, 105-119.
17. Guilford, M.; Hall, C.A.S.; Cleveland, C.J. New estimates of EROI for United States oil and gas, 1919–2010. *Sustainability* **2011**, *3*, 1866-1887.
18. Cleveland, C. Net energy from the extraction of oil and gas in the United States. *Energy* **2005**, *30*, 769-782.
19. *1992 Census of Mineral Industries*; U.S. Bureau of the Census: Washington, DC, USA, 1996.
20. *1997 Census of Mineral Industries*; U.S. Bureau of the Census: Washington, DC, USA, 2001.
21. *2002 Census of Mineral Industries*; U.S. Bureau of the Census: Washington, DC, USA, 2005.
22. *Annual Energy Review 2006*; U.S. Energy Information Administration: Washington, DC, USA, 2007.
23. *Digest of United Kingdom Energy Statistics: 2007*; U.K. Department for Business Enterprise and Regulatory Reform: London, UK, 2007.
24. *Digest of United Kingdom Energy Statistics: 2005*; U.K. Department of Trade and Industry: London, UK, 2005.
25. *Global Upstream Performance Review*; John S. Herold, Inc.: Norwalk, CT, USA; Harrison Lovegrove & Co. Ltd.: London, UK, 2007.
26. Rodriguez X.A., Arias, C. The effects of resource depletion on coal mining productivity. *Energy Econ.* **2008**, *30*, 397-408.
27. Tilton, J.E. Assessing the threat of mineral depletion. *Minerals & Energy* **2003**, *18*, 33-42.
28. King, C.; Hall, C.A.S. Relating financial and Energy Return on Investment. *Sustainability* **2011**, *3*, 1810-1832
29. Norwegian Petroleum Directorate, fact pages. Available online: <http://www.npd.no/engelsk/cwi/pbl/en/index.htm> (accessed on 25 January 2010).
30. Murphy, D.; Hall, C.A.S. Order from chaos: A preliminary protocol for determining EROI for fuels. *Sustainability* **2011**, *3*, 1888-1907.
31. Henshaw, P.F.; King, C.; Zarnikau, J. System Energy Assessment (SEA), defining a standard measure of EROI for energy businesses as whole systems. *Sustainability* **2011**, *3*; 1908-1943

32. Bøeng, A.C. Statistics Norway, Oslo, Norway. Personal communication, 2010.
33. Hult, R. *Norwegian Petroleum Directorate*; Stavanger, Norway. Personal communication, 2009.
34. *Development of the Oil and Gas Resources of the United Kingdom 2001*; UK Department of Trade and Industry: London, UK, 1984-2004. Available online: <http://www.dbd-data.co.uk/bb2001/book.htm> (accessed on 15 January 2010).
35. UK Department of Energy and Climate Change. Petroleum production data. 1980- 2008. Available online: https://www.og.decc.gov.uk/pprs/full_production.htm (accessed on 15 January 2010).
36. *Oil and Gas Activity 4th Quarter 1999*; Statistics Norway: Oslo, Norway, 2000.
37. *Oil and Gas Activity 4th Quarter 2004*; Statistics Norway: Oslo, Norway, 2005.
38. Jama, S. *Statistics Norway*, Oslo, Norway. Personal communication, 2010.
39. Statistics Norway. Norwegian GDP. Available online: http://www.ssb.no/nr_en/tabe-01.html (accessed on 15 May 2010).
40. Statistics Norway. Norwegian CPI. Available online: http://www.ssb.no/kpi_en/tab-01-en.html (accessed on 15 May 2010).
41. Statistics Norway. Net energy consumption. Available online: http://www.ssb.no/english/subjects/01/03/10/energiregn_en/tab-2010-04-23-06-en.html (accessed on 15 August 2010).
42. *Økt utvinning på norsk kontinentalsokkel. En rapport fra utvinningsutvalget*. Ministry of Petroleum and Energy: Oslo, Norway, 2010. Available online: <http://www.regjeringen.no/upload/OED/pdf%20filer/Oktutvinning.pdf> (accessed 26 September 2010).

© 2011 by the authors; licensee MDPI, Basel, Switzerland. This article is an open access article distributed under the terms and conditions of the Creative Commons Attribution license (<http://creativecommons.org/licenses/by/3.0/>).

Article

Oil Depletion and the Energy Efficiency of Oil Production: The Case of California

Adam R. Brandt

Department of Energy Resources Engineering, Green Earth Sciences 065, 367 Panama St., Stanford University, Stanford, CA 94305-2220, USA; E-Mail: abrandt@stanford.edu; Fax: +1-650-724-8251

Received: 10 June 2011; in revised form: 1 August 2011 / Accepted: 5 August 2011 /

Published: 12 October 2011

Abstract: This study explores the impact of oil depletion on the energetic efficiency of oil extraction and refining in California. These changes are measured using energy return ratios (such as the energy return on investment, or EROI). I construct a time-varying first-order process model of energy inputs and outputs of oil extraction. The model includes factors such as oil quality, reservoir depth, enhanced recovery techniques, and water cut. This model is populated with historical data for 306 California oil fields over a 50 year period. The model focuses on the effects of resource quality decline, while technical efficiencies are modeled simply. Results indicate that the energy intensity of oil extraction in California increased significantly from 1955 to 2005. This resulted in a decline in the life-cycle EROI from ≈ 6.5 to ≈ 3.5 (measured as megajoules (MJ) delivered to final consumers per MJ primary energy invested in energy extraction, transport, and refining). Most of this decline in energy returns is due to increasing need for steam-based thermal enhanced oil recovery, with secondary effects due to conventional resource depletion (e.g., increased water cut).

Keywords: oil depletion; energy return on investment; energy efficiency

1. Introduction: Oil Depletion and the Energy Return of Low Quality Oil Resources

A transition in oil production has been occurring for decades: the fuels that consumers put into their automobiles are being produced using increasingly energy-intensive production methods, and from resources other than “conventional” oil. This transition is the result of three trends occurring worldwide: output from existing oil fields is declining, new fields are not as large or productive as old fields, and

areas with conventional resources are increasingly off-limits to investment by independent oil companies. These trends are inducing investment in substitutes for conventional petroleum, such as the Alberta tar sands, or synthetic fuels from coal or oil shale [1].

Historically, the most common substitutes for conventional oil have been low-quality hydrocarbons, such as the heavy oils in California and bitumen in Alberta. These resources are more difficult to extract than conventional petroleum, are more difficult to refine into finished fuels, and are more expensive. Much of this increased cost and difficulty is due to larger energy demands for extraction and refining. For example, in California, thermally-produced heavy oil requires the injection of steam to decrease the oil viscosity and induce flow within the reservoir. Also, refining heavy oil is more energy intensive due to the fact that it is hydrogen deficient and often impurity-laden.

This oil transition will cause growing tension in the coming decades: a transition to low-quality oil resources will reduce our ability to improve the environmental profile of energy production—an imperative for the twenty-first century—but increasing demand for fuel from developing countries could increase market instability and competition over constrained oil resources.

The nature of oil depletion is understood mostly by studying aggregate statistics such as regional production curves [2–4]. Due to the lack of publicly available data, little research has been performed on the specific effects of depletion on oil operations (e.g., effects of depletion on required capital investment versus operating expenses). Also, only a small amount of attention in the peer-reviewed literature has been paid to the energy efficiency impacts of oil depletion [5,6].

This paper seeks to explore these energy efficiency impacts by building a detailed model of California oil production over time. First this paper presents a history of California oil production, focusing on changing oil resource quality and resource depletion. Next, methods for calculating energy inputs and outputs from oil production are described. Using these energy inputs and outputs, energy return ratios are computed using methods of life cycle assessment (LCA) and net energy analysis (NEA). Lastly, results from these calculations are presented and their broader significance is discussed.

2. An Industrial History of California Oil Production: Resource Quality, Depletion, and Innovation

2.1. Early Oil Production Before 1900

Pre-commercial use of oil in California included use by Native Americans for coating, sealing and adhesion [7]. Early commercial production was concentrated in the San Joaquin valley of California, where low-quality surface oil was mined in pits and tunnels [8]. The first refinery—a simple still for batch processing with a capacity of 300 gallons—was constructed near McKittrick in 1866, but it soon failed due to poor economics and high transport costs [7]. Figure 1 shows historical milestones in the California oil industry plotted along with production volumes [9,10].

Figure 1. History of California oil production. Data from the American Petroleum Institute (API) [9,10]; timeline elements from multiple sources cited in text.

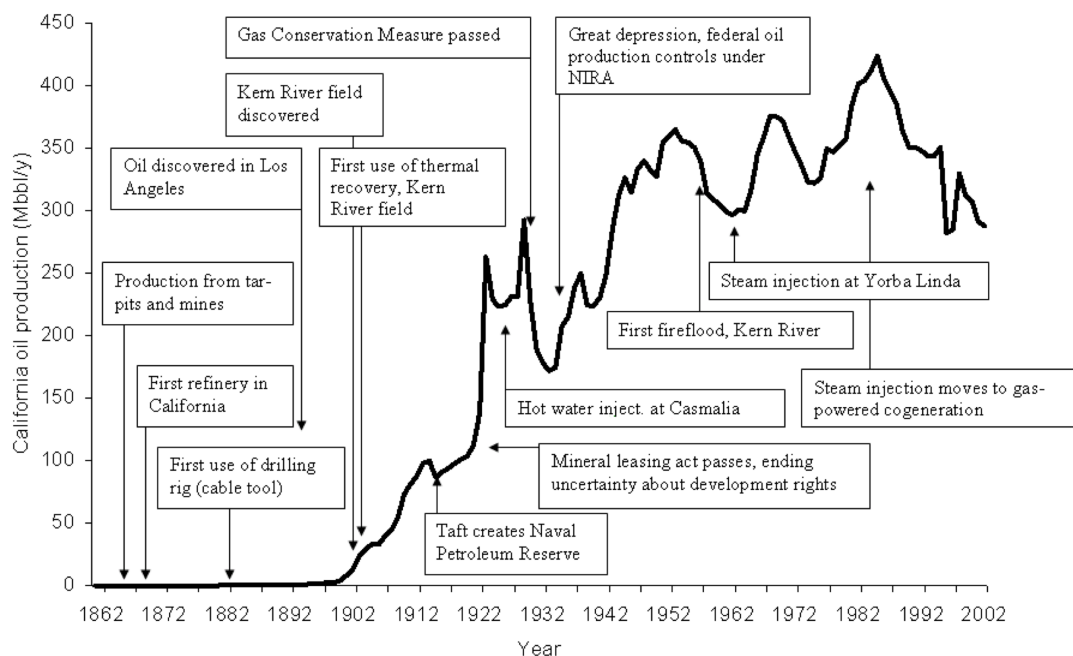

By the 1890s, surface mining had declined in importance and the cable tool rig had become the standard drilling method in California. Power for the cable tool rig was provided by a steam engine, and drilling power increased rapidly: Drake's famous rig generated 4.4 kilowatts (kW) in 1859, and by 1900, steam boilers were rated at 29 kW, and the attached steam engines were rated at 18 kW [7].

Oil became a socially and economically dominant industry in the San Joaquin Valley with the discovery of the Kern River field in May of 1899. The proximity of this field to Bakersfield allowed the shipment of oil via rail to San Francisco. By 1903, Kern River production increased to 17 million barrels per year, or $\approx 70\%$ of California's production. No gushers were ever found in the Kern River field, due to its low initial pressure (1.2–3.8 megapascal (Mpa) and heavy viscous oil (0.96–1.0 specific gravity, and up to 10,000 centipoise viscosity) [11].

Early oil production was inefficient and wasteful, due to a combination of poor knowledge of geological principles and poor ability to control production. Early producing wells often declined rapidly, particularly in the Los Angeles basin [7]. This is because producers would withdraw and often vent or flare the associated gas, depleting the reservoir drive. These depleted wells, generally producing only a few barrels per day, were often sold off by their operators. Industrious producers would buy up contiguous depleted wells and apply technology to increase production. Operators would commonly attach a central oil-fired pumping unit to serve numerous wells simultaneously [7]. This represents an early example of self-consumption of oil by producers to offset the effects of depletion.

2.2. Early 20th Century Production: 1900–1940

The first recorded attempt at thermal enhanced oil recovery (EOR) was by J.W. Goff in 1901 [7]. He had no experience in the oil industry, but he attempted to solve the problems of the producers in

the Kern River field, who struggled with its heavy oil. He injected steam, air, and steam-heated air into wells. Goff achieved a small amount of incremental production, but depressed oil prices stymied his early attempt at EOR [7].

An important technological development in the early 1900s was the advent of the rotary drilling rig as a replacement for the cable-tool rig. The first committed effort to rotary drilling in California was by Standard Oil in 1908. Early rotary rigs were powered by steam engines, which were replaced by internal combustion engines by the 1930s. Rotary drilling eventually dominated oil well drilling, as it was faster and more effective.

Efforts in the late 1920s and 1930s focused most visibly on attempting to drill deeper. Deep oil had been found at Kettleman hills: 635 m³/d (4000 bbl/d) from a single well, 2133 m deep, producing valuable light oil (0.74 specific gravity) [12]. This encouraged others to drill deeper wells in existing fields. Thermal methods were also experimented with briefly in this period, with the Tidewater oil company injecting hot water into the Casmalia field in 1923 (Casmalia oil is dense and viscous, having a specific gravity as high as 1.015 [11]).

These early attempts at enhanced oil recovery were not successful, as ample production from high-quality light oil fields at the time made these operations costly and unneeded. Per-well yearly production rates peaked in the 1930s, reaching \approx 24,000 bbl/well in 1930 and declining thereafter to less than 5,000 bbl/well in the current day.

2.3. The Modern Era of California Oil Production: 1940 to 2000

In the post-war period, discovery of large new fields declined. Research attention focused on ways to extract a larger share of California's vast heavy oil resources. Knowing that heat reduces the viscosity of crude oil, in 1956 engineers attempted to light a fire downhole in the Midway-Sunset field by injecting air and using a novel electric ignition system. This method is called in situ combustion or "fireflooding". The ignition system was unnecessary, as injected air caused spontaneous combustion [13].

Other companies utilized bottomhole heaters. These heaters took heat generated at the surface and transmitted it to the formation using a heat exchanger. These had much lower capital costs than the air compression equipment required for fireflooding (1 M\$ for compressor vs. 3000\$ for a bottomhole heater) [13]. The biggest success for the bottomhole heaters occurred in the Kern River field. Engineers concluded that heat conduction from the bottomhole heaters was slow and ineffective, and that more effective thermal production would require injecting heat-conducting fluid into the reservoir body.

The first modern steam injection project recorded in California was in April of 1960. Shell had studied potential steam injection processes in the laboratory and carried out secret pilot projects at the Yorba Linda field (specific gravity of 0.986) [13]. This was followed by a Kern River project in August of 1962 [14]. The success of these projects caused rapid spread of the technology across the industry. Many steam injection projects were built quickly: in 1964 and 1965 more than 50 steam injection projects were initiated each year [14]. Production increased significantly in fields where steam injection was instituted (see Table 1).

Table 1. Pre-steam and post-steam maximum oil production levels in selected fields [8,11].

Field	Pre-steam			Post-steam		
	Year	Prod. (10 ⁶ m ³)	Prod. (Mbbbl)	Year	Prod. (10 ⁶ m ³)	Prod. (Mbbbl)
Kern River	1904	2.73	17.2	1985	8.20	51.6
Midway-Sunset	1914	5.46	34.4	1991	9.74	61.3
South Belridge	1945	0.73	4.6	1987	10.11	63.56

Oil production continued to increase in the 1960s. Production increased to over 160×10^3 m³/d (1 Mbbbl/d) in the mid 1960s, reaching a plateau that lasted \approx 20 years [15]. Simultaneously, production per well dropped, reaching 4 m³/well-d (25 bbl/well-d) in 1963 and never rising above this level again [15]. This is because much of the incremental production in this period was not from new large fields or gushers, but instead from increasing the intensity of extraction in depleted fields using advanced recovery technologies. Infill drilling (the drilling of wells on closer spacing in already producing fields) was aided by powerful drilling rigs: by the 1980s, rigs put out \approx 350–850 kW, or 11–30 times the output of rigs from the turn of the century [16].

In the late 1970s and 1980s, regulatory attention focused on air quality impacts of thermal enhanced oil recovery. The California Air Resources Board (CARB) studied the problem between 1979 and 1983 [16]. Because unrefined crude oil was burned for steam generation, emissions from steam generators contained sulfur, nickel, and vanadium. By 1982 a variety of regulatory controls were in place [17], and over the course of the 1980s, EOR boilers were largely converted to natural gas fuel.

Concerns about energy efficiency of steam injection caused cogeneration of heat and power to be implemented in California TEOR projects in the 1980s. In 1978, the California Energy Commission (CEC) considered the feasibility of cogeneration in California thermally enhanced oil operations [18]. Projects were added throughout the 1980s and 1990s, and generation capacity from these oilfield projects reached \approx 2000 MW by 2004, or 4% of California's electricity generation capacity [19]. Air quality regulations have reshaped thermal oil recovery: only three projects remain that use petroleum coke and coal, and no projects use oil produced from the field itself, the primary fuel for all early oil field steam generation projects. Both major steam injection projects in the Los Angeles air basin were closed in 1999, due in part to the cost of emissions allowances [19].

Total California oil production reached its peak in 1984 at $\approx 190 \times 10^3$ m³/d (1.2 Mbbbl/d), and is in terminal decline (see Figure 1) [20]. Per-well yearly production rates are currently less than 5,000 bbl/well, down from a peak of \approx 24,000 bbl/well in 1930. Over 17% of California oil production in 2008 was produced from stripper wells—defined by the California Department of Oil, Gas, and Geothermal Resources as wells producing less than 10 barrels per well per day. Some 59% of operating wells in California are now classified as stripper wells [21].

3. Methods—Energy Return Ratios Based on a Bottom-up Life Cycle Framework

This study quantifies the energy efficiency impacts of oil depletion in California using methods of life cycle assessment (LCA) [22,23] and net energy analysis (NEA) [24,25]. The analysis requires calculating energy inputs and outputs from all process stages, in a similar fashion to LCA. This set of flows will allow “bottom-up” calculation of net energy returns at either the point of extraction or at the point of consumption of finished fuel (full-fuel cycle EROI). This bottom-up approach differs from “top-down” approaches based on aggregate industry statistics or reported economic flows between sectors.

To quantify these effects, a time series of life cycle energy inputs and outputs from oil extraction is constructed. Dynamic or time-varying LCA has been performed in the past using a variety of methods. Pehnt studied the impacts of renewable energy technologies over time, finding that the impacts become less over time as the result of increasing efficiency of materials extraction and refining [26]. Levasseur *et al.* have constructed a framework for dynamic accounting of GHG impacts given time variation in releases and the decay characteristics of GHGs over time [27]. Most closely related to this effort, Mendivil *et al.* studied the changes over time in the life cycle air emissions from ammonia synthesis from 1950 to 2000 [28]. Using information from patents and industry literature, they constructed an LCA model of different types of ammonia technology, and estimated emissions resulting from each technology over time.

3.1. A Bottom-Up Model of Energy Inputs and Outputs

Our process model (see Figure 2) includes three process stages: primary energy extraction, upgrading of primary energy into forms usable by consumers (in this case refining), and consumption of refined energy in non-energy sectors. Both direct and indirect consumption of energy in oil extraction is accounted for as the flow of refined product back into the system (e.g., the model includes both refined fuels used directly in oil extraction, such as diesel fuel used in drill rigs, as well as those fuels consumed indirectly, like diesel fuel used during steel manufacture). This model formulation—with self consumption included—accounts for the fact that a fraction of the primary energy produced is used to extract more primary energy.

In Figure 2, the F quantities represent flows of the principal energy stream, x flows represent energy consumed in the extraction and conversion processes, and w flows represent output of waste heat and wasted energy. This framework resembles that developed originally by the Colorado Energy Research Institute [25]. Numerical subscripts refer to process stage (1 = extraction, 2 = refining), while letter subscripts reflect the nature of the input (e = external, c = crude, r = refined). Since the purpose of extracting energy is to allow consumption in non-energy sectors, flows F_f represent the goal quantity. The process studied results mostly in refined oil products output $F_{f,oil}$; because of co-production of natural gas and electricity (through cogeneration) the model includes co-product outputs $F_{f,gas}$ and $F_{f,e-}$.

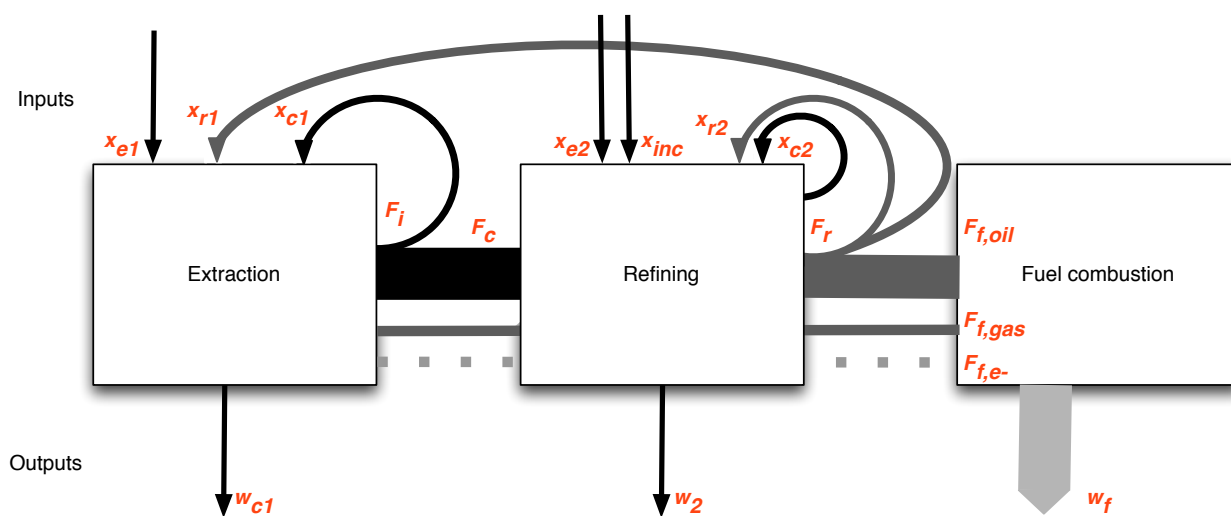
Figure 2. Three-stage energy capture, conversion, and consumption process.

- F_i = Gross flow of crude oil output from well
 x_{c1} = Self-consumption of crude oil for extraction
 x_{r1} = Consumption of refined product directly and in directly in extraction
 x_{e1} = Consumption of external energy in extraction
 w_1 = Wasted heat from upstream production as well as wasted produced gas (due to venting & flaring)
 F_c = Net flow of crude oil output from field
 x_{c2} = Self consumption of crude oil for refining
 x_{r2} = Consumption of refined product directly and indirectly in refinery
 x_{e2} = Consumption of external energy in refining
 x_{inc2} = Addition of incremental energy to the stream of refinery products (e.g., hydrogen added from external natural gas)
 w_2 = Waste heat resulting from consumption of energy in refining
 F_r = Gross outflow of refined products from refinery
 $F_{f,oil}$ = Net flow of refined oil products to non-energy sectors of economy
 $F_{f,gas}$ = Net flow of co-produced natural gas to non-energy sectors
 $F_{f,e-}$ = Flow of electricity to non-energy sectors
 w_f = Waste heat released upon combustion of refined products in non-energy sectors.

This model has much in common with LCA of fuel cycles. This is not surprising, given the common origins of LCA and energy analysis [24]. LCA models have been used previously to assess the net energy availability from resources. For example, Farrell *et al.* studied a variety of fuel ethanol production pathways using LCA, and computed energy return ratios at the same time [29].

3.2. Calculating Energy Return Ratios

Oil has been the subject of a number of NEA studies that have calculated energy return ratios [5,6,30–32], but previous analyses have generally been based on high-level datasets (e.g., national datasets). There are a number of energy return ratios used in NEA. Defined most simply, the net energy output from an energy extraction and refining process is the energy made available from a natural resource in useful, refined form less that energy consumed in extracting, upgrading and converting it to that form [24]. Energy return ratios of various types can be constructed, generally with a measure of energy output in the numerator and a measure of energy consumed in the denominator. The most common energy return ratio is the net energy ratio (NER), also called the energy return on energy invested (EROI) [33]. Other metrics include the external energy ratio (EER) [34, Table A-1]:

$$NER \text{ or } EROI = \frac{E_{out}}{E_{ext} + E_{int}} \quad (1)$$

$$EER = \frac{E_{out}}{E_{ext}} \quad (2)$$

In these equations, E_{out} is the final refined product output, E_{ext} is primary energy input from outside the studied system (such as primary energy to create electricity purchased from the grid), and E_{int} is primary energy input from the feedstock resource itself (e.g., crude oil burned on-site for steam generation). The EER compares energy inputs from outside the system to net outputs from the process. It reflects the ability of a process to increase energy supply to society. The NER compares *all* energy inputs to net outputs. It is therefore a better metric for understanding environmental impacts from producing a fuel (e.g., GHGs) [34].

The definitions of EROI and EER given our framework are shown in Table 2. Note that there are two possible system boundary configurations when deriving EER: refined fuel consumed by the system itself can either be considered an internal or external energy source. For example, diesel fuel used to power drilling rigs could either be considered an internal energy source, (“loose” system boundary) or could be considered a final energy product that is diverted back into the process (“tight” system boundary). For the EER calculated here, the model uses the tight system boundary. This choice is made because the refined fuel leaving the refinery gate be used for final consumption, so its diversion back into oil extraction is classified as an external energy input.

Table 2. Energy ratios and their uses.

Name	Tight system boundaries	Loose system boundaries	Characteristics
NER/EROI	$\frac{\sum F_f}{\sum x}$	$\frac{\sum F_f}{\sum x}$	Net energy ratio. Ratio of outputs to total energy consumed in production. All x flows are included because ratio includes consumption of self produced energy. EROI provides understanding of overall efficiency of process and is proportional to impacts associated with energy use (e.g., environmental impacts).
NER/EROI (POE)	$\frac{F_c}{x_{e1}+x_{r1}+x_{c1}+x_{wc1}}$	Same	Net energy ratio at point of extraction. As above, except calculated at the point of crude oil extraction rather than on refined fuel basis.
EER	$\frac{\sum F_f}{x_{r1}+x_{r2}+x_{e1}+x_{e2}}$	$\frac{\sum F_f}{x_{e1}+x_{e2}}$	External energy ratio. ^a Refined energy provided to non-energy sectors of the economy, divided by the energy input from external energy system. Indicator of ability of process to increase energy supply to society.
EER (POE)	$\frac{F_c}{x_{e1}+x_{r1}}$	Same	External energy ratio calculated at the point of extraction. As above, except calculated at the point of crude oil extraction rather than on refined fuel basis.

a - This quantity has also been called External Net Energy Ratio (ENER) [25].

Another difficulty with this bottom-up modeling approach is that there is no clear way to separate the oil energy extraction chain completely from other extraction chains such as coal production. For

example, some of the final products from oil and gas extraction will in fact go to other energy extraction sectors either directly or indirectly, not to non-energy end consumers. This is a related problem to the general system boundary problem in LCA: determining where your “system” begins and ends is not trivial and there is no unambiguously correct approach to doing so. These complexities are ignored for the first-order model created here.

Energy return ratios give insight into the quality of the resource: a high quality resource will require less energy to extract and upgrade than a low-quality resource. These ratios also give some sense of the efficiency with which industry is able to extract resources. Over time, as technologies become more efficient and their usage is systematically improved through research and development, the energy return ratios will improve for a given level of resource quality. Energy return ratios are only partially correlated with other metrics of interest, such as the cost of a resource and the its environmental impacts [24]. In their favor, however, they can illustrate fundamental qualities of the resource that can be obscured by economic or environmental metrics.

Clearly then, the energy requirements of crude oil extraction and refining depend both on the quality of the resource and the technical efficiency with which industry extracts and refines the resource. For example, quality factors might include the volumes of water lifted per unit of oil produced, or the depth of fields accessed over time. Efficiency factors might include the efficiency of pumps or the refining energy intensity. The distinction between these types of factors is discussed more below.

3.3. Calculating Energy Inputs and Outputs for the California Case

The model of California oil production developed here generates estimates for energy return ratios as a function of time. Using ranges of data available in the literature, the model is used to calculate Low and High cases. The Low case represents more favorable energy returns (low inputs per unit of output) while the High case represents less favorable energy returns (high inputs per unit of output).

Sources of data used are listed in Table 3 [35]. Many data are from the *California Department of Conservation - Department of Oil, Gas, and Geothermal Resources* (CDC-DOGGR). Production and drilling data are collected at the field level for 306 California fields, while exploratory drilling was collected at the state level (drilling outside of established fields). Fields removed from the analysis are a fields that are classified as gas fields by CDC-DOGGR, as well as fields in Federal offshore waters (due to poor data availability). Field depth and API gravity data of some quality are available for nearly all fields. If a single overall value was available for a field, it is used. If only pool-level data were available for a given field, the relative importance of different pools is used to weight pool-level data. If no relative production data were available by pool, pool values are averaged. Sulfur content is not included in the model because many fields are missing sulfur content data.

Data entry was performed from PDF files of original CDC-DOGGR data. Because of the effort involved in data handling (building spreadsheets, checking data quality, computing results), a reduced frequency of data sampling was chosen. Because long-term trends are of interest in this study, results are calculated every 10 years rather than every year. The model could be used to calculate model results on a yearly basis rather than a decadal basis. The decision to sample data was driven by the cost of data entry, coupled with the effort involved in handling data.

Table 3. Data inputs to model of California oil production.

Data input	Source	Scale	Years
Oil production	[36]	306 fields	1955–2005
Water production	[36]	306 fields	1955–2005
Development wells drilled	[36]	306 fields	1955–2005
Exploratory wells drilled	[36]	State-wide	1955–2005
Steam injection	[36]	306 fields	1965–2005
API gravity	[11]	Pool/field	NA
Depth	[11]	Pool/field	NA
Drill rig efficiency	[37,38]	3 reported efficiencies	≈ 1950, 1975, 2005
Electricity efficiency	[39]	US average efficiency	1955–2005

In general, the above data generally reflect quality factors rather than efficiency factors: public production statistics include activity data such as volumes lifted or wells drilled, but technical efficiencies are not generally not made public (e.g., no agency requires pump efficiencies to be reported). This contributes to uneven data quality in model functions. Time-varying technical efficiency data are gathered where possible; otherwise, efficiencies are held constant or modeled very simply.

3.3.1. Energy Content of Produced Oil

The energy content of produced crude oil is calculated using produced oil volumes for each field. Oil is assigned API gravity associated with that field. The energy density of crude oil is computed as a function of API gravity [40].

3.3.2. Drilling Energy Use

Drilling activity data are calculated using field-level development drilling and data on exploratory drilling. Dry holes are included in exploratory drilling data. The total energy consumed in drilling is:

$$x_{r1d} = \sum_{i=1}^{306} W_i \Delta h_i E_d(\Delta h_i) + W_{exp} \Delta h_{exp} E_d(\Delta h_i) \quad (3)$$

where index i represents a field, W_i is the number of development wells drilled in that field, and Δh_i is the average depth of that field (m). Similarly, W_{exp} and Δh_{exp} are the exploratory wells drilled and assumed depth of exploratory wells (1500 m on average). E_d is the energy requirement of drilling in MJ/m, and is a function of h_i . Reported drilling activity data are presented in Figure 3. Increased drilling in 1985 was likely induced by the high oil prices of the late 1970s and early 1980s.

All drilling energy is assumed to be provided by diesel-powered drill rigs. Drill rig energy consumption data are difficult to obtain. Using estimates from drilling companies [41,42] and data on fuel consumption in drill rig engines [37], energy consumption in modern oil well drilling was previously estimated as 250 MJ/m (low case) and 400 MJ/m (high case) for shallow wells (1000 m and less) [43].

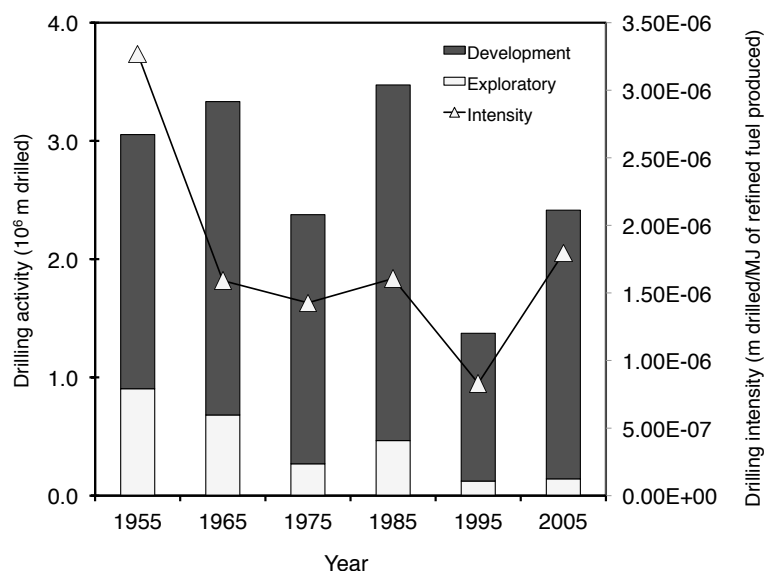
Figure 3. Drilling activity data: Yearly depth drilled over time in California oil industry.

The amount of time required to drill a well, and consequently the energy consumed, tends to increase exponentially with depth [44]. Using data from modern Canadian well drilling data [45–47] the following relationships between MJ/m and well depth are generated:

$$E_{d,low} = 128.6 \cdot e^{(0.0005d)} \quad (4)$$

$$E_{d,high} = 336.3 \cdot e^{(0.0004d)} \quad (5)$$

where E_d is measured in MJ/m and d is the measured well depth in m (not true vertical depth in deviated wells). These relationships have r^2 values of 0.71 and 0.59, respectively. These results are used to calculate modern well drilling energy intensities.

Changes in drilling energy intensities over time can only be approximated. Drill rig engine sizes increased by at least a factor of 4 over the modeled time period, from 200–375 kW in 1950 [48, p. 159] to ≥ 800 kW in 1975 and ≥ 1500 kW in 2005 [37]. This additional power resulted in faster drilling, but it is unclear if power increases resulted in more energy efficient drilling (on a MJ/m basis).

Improvement in efficiency of diesel engines was slow over the modeled time period. Large marine diesel engines reached efficiencies near present-day efficiencies by the 1950s, with thermal efficiencies of 45% achieved by 1950 [49]. Smaller diesel engine efficiencies lag behind large engine efficiencies: Caterpillar engines for land-based drilling rigs have increased in efficiency from from 0.31 to 0.41 MJ motive power/MJ fuel, lower heating value (LHV) basis over the modeled time period [37,38,48]. All engines compared are Caterpillar drill rig engines. 1955 engines included Caterpillar models D364, D375, D397 [48, p. 174]. The model includes data on D397, as this was the largest engine with ≈ 375 kW output at 1200 rpm. D397 fuel input at its most efficient was interpolated from figures on specification sheet to be 0.42 lb fuel per brake horsepower hour produced [38]. Using cited fuel energy density of 19,000 BTU/lb, this amounts to a technical efficiency of 0.313 MJ motive power per MJ of

input diesel (LHV basis). For 1975 and 2005 engines, data from Caterpillar Repower brochure suggest engines of the time were the D399 and 3516 [37,50, Reported fuel consumption rates imply efficiencies of 0.334 and 0.405, LHV basis, respectively, from these engines]. The model interpolates these changes over modeled period, resulting in drilling fuel consumption multipliers of 1.29 in 1955, 1.21 in 1975, and 1.00 in 2005.

Energy costs of cement and steel are included [51]. The methods used are equivalent to those used in a previous analysis of in situ oil shale development [43], with energy intensities of $\approx 19,000$ MJ/tonne of steel and 2400 MJ/m³ of cement. Energy consumed in steel and cement manufacture are relatively small compared to direct drilling energy inputs (steel = 1/4, cement = 1/30).

3.3.3. Energy Costs of Lifting

Lifting activity data collected include volumes of fluids lifted per field per year, including oil, water and gas. Oil volumes are converted to masses lifted using the specific gravity of individual fields' oil output. Oil and water lifted over time are plotted in Figures 4 and 5.

Figure 4. Lifting activity data: volumes of oil and water produced over time.

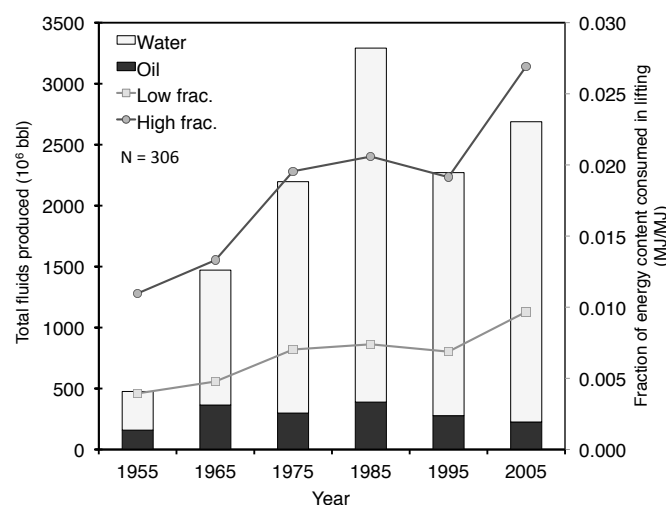

Technical efficiencies are calculated assuming pumping is provided by electric-powered sucker-rod pumps (SRPs) [52]. Pumping in California oil fields is in most cases electric, and 80% of oil well pumps are SRPs [52]. Pumping efficiency is determined by mechanical losses, friction in well bores, and electricity generation efficiency. The energy requirements of crude oil lifting are derived from a modified version of a pressure drop equation [53]:

$$x_{e1,i}^l = -E_i^P + E_i^G + E_i^F + E_i^A \quad (6)$$

where $x_{e1,i}^l$ is the external energy input to lifting for field i ; E^P is energy provided by the pressure drop from the reservoir to the outlet of the well (reservoir energy imparted to the fluid); E^G is the energy required to lift fluids against gravity; E^F is energy dissipated by friction between flowing fluid and

Figure 5. Fractional water cut over time in California oil fields. Circles represent average over 306 California fields, with ± 1 SD. Diamonds represent aggregate values for whole California industry (total water produced over total fluids produced).

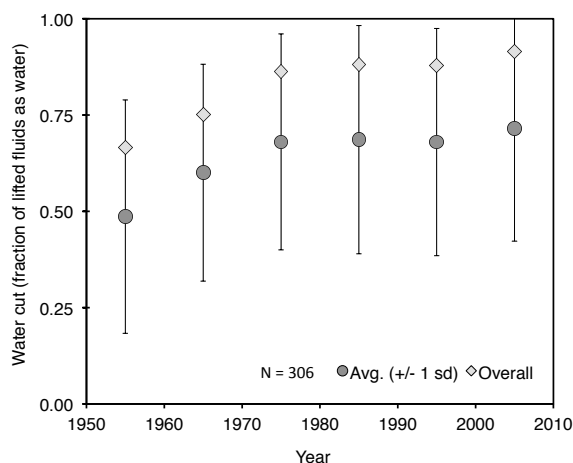

pipe as well as energy dissipated in friction and losses within the mechanical system; and E^A is energy consumed to accelerate the fluid (Δ kinetic energy).

The change in kinetic energy (E^A) is often neglected, so I ignore it here [53] (Fluids are not moving appreciably faster at the surface than in the wellbore, and kinetic energy quantities are small for observed velocities.) Since data on well pressures by field and time are not available, the model also neglects energy supplied by reservoir pressure drawdown (E^P). The model represents losses E^F with an efficiency multiplier [54]. SRP efficiency η_{pump} is the product of mechanical efficiency, η_m , electric motor efficiency, η_t , efficiency of lifting, η_l , and efficiency of electricity generation η_e [54] [55]. So for a given oil field i :

$$x_{e1,i}^l = \frac{E_i^G}{\eta_{pump}} = \frac{m_i g \Delta h_i}{\eta_{pump}} = \frac{(m_i^o + m_i^w) g \Delta h_i}{\eta_m \eta_t \eta_l \eta_e} \quad (7)$$

where: m is mass lifted (kg oil and water), g the gravitational constant, and Δh is the height lifted (m). m increases per unit of oil produced as the water cut (the fraction of water in the produced fluids) increases over time (see Figure 5). These lifting energy inputs for each field can be summed to provide the total lifting energy input.

Given that sucker rod pumps are a relatively simple and mature technology, the model assumes no changes in pump efficiency (η_m , η_l) over the modeled time period. Data from EIA are used to calculate η_e , using US average electricity generation efficiency (improves from 26.2% in 1955 to 31.4% in 2005) [39]. Ideally, California-specific electricity efficiencies would be used, but EIA state data are only available to 1990. Data from Ayres *et al.* are used to calculate changes to electric motor efficiency over time (η_t improves from 79.1% to 90%) [56].

3.3.4. Steam Injection for Thermal Enhanced Oil Recovery

Steam injection activity data were first reported in 1966, so 1966 data are used as a proxy for 1965 steam injection values. Total volumes of steam injected are multiplied by the energy requirements per barrel of steam generated. Steam is modeled as requiring 1990–2330 MJ/m³ (0.3–0.35 mmBtu/bbl) of cold water equivalent steam (Low case–High case) [57]. All steam is assumed to be generated in 75–85% efficient (High case–Low case, LHV basis) once-through steam generators [58], except for steam generated with cogeneration systems (see below). Due to lack of data suggesting otherwise, the model assumes that efficiency of steam generation stays constant across the modeled time period. For a more thorough analysis of the emissions and efficiency of TEOR, see work by Brandt and Unnasch [59].

The energy requirements of steam production are normalized by the total crude energy produced and are plotted in Figure 6. This figure shows that in recent decades, over 15% of the equivalent energy content of produced crude in California has been used for steam generation. This significant increase in the energy consumed in steam generation reduces both the NER and (once external natural gas begins to be consumed in the 1980s) the EER. No data are reported on steam production fuel by year, so the fraction fueled with crude oil and natural gas is estimated from the history of industry regulation above: all steam is assumed to be produced with produced oil until 1985, when 50% is assumed to be produced with natural gas. From 1995 onward, all steam is assumed produced with natural gas (see Figure 7 for data on expansion of natural gas fired cogeneration).

Figure 6. Calculated energy inputs to steam production, as fraction of gross energy output from crude oil extraction.

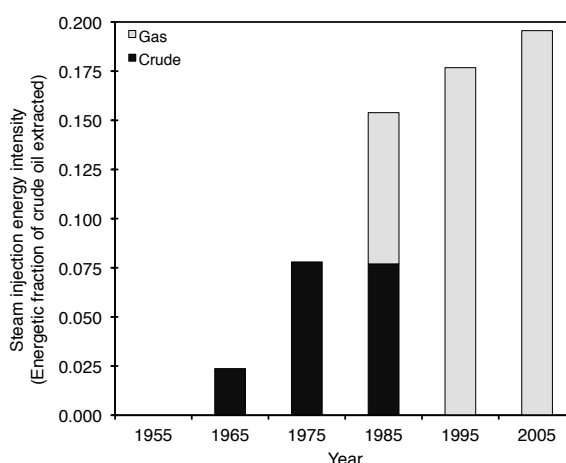

In the 1980s, as the transition to natural gas was occurring, oil producers added cogeneration facilities. This expansion of TEOR cogeneration capacity is shown in Figure 7. For inclusion in total EROI and EER figures, electricity flow $F_{f,e-}$ is weighted by a factor of 3 to account for its approximate 33% conversion efficiency from primary energy.

Cogeneration efficiency and steam/power ratios are taken from Brandt and Unnasch [59], given by cogeneration low and cogeneration high cases. These efficiencies account for the larger natural gas

Figure 7. Expansion of cogeneration capacity in California TEOR operations [60]. Left axis is capacity (MW, plotted with circles), right axis are low and high estimates of electricity production (MWh/y, plotted with dotted lines) assuming 75% and 90% capacity factors, respectively [60].

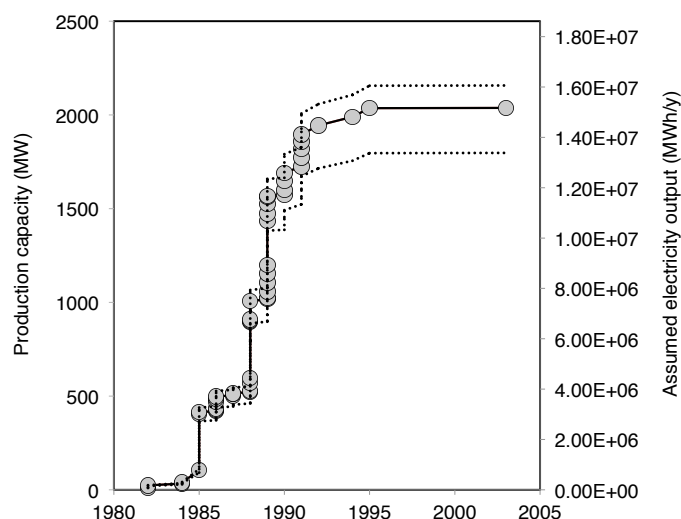

demand due to co-production of electricity (e.g., only $\approx 45\%$ of thermal energy is imparted to steam). This additional natural gas demand offsets some of the energetic benefits of co-producing electricity.

3.4. Refining Energy Inputs

The model uses a linear function for refining energy consumption variation with crude specific gravity, derived from results of Keesom *et al.* [61], who modeled refinery energy consumption for 11 crude streams ranging from 0.842 to 1.011 specific gravity. Linear functions are fit to reported internal and external energy inputs to refining as a function of crude volumes, arriving at an overall equation for crude refining energy use:

$$x_{c2} = \sum_{i=1}^{306} (10469SG_i - 6902.9)P_i \quad (8)$$

$$x_{e2} = \sum_{i=1}^{306} (1628SG_i + 1084.4)P_i \quad (9)$$

$$x_{c2} + x_{e2} = \sum_{i=1}^{306} (12097SG_i - 5818.6)P_i. \quad (10)$$

where SG_i is the specific gravity of crude produced from each field i and P_i is the volume of crude inputs to refining from field i (m^3). The units of energy consumption are MJ/m^3 of crude oil input to refining. The linear fit to $x_{c2} + x_{e2}$ has an r^2 of 0.86. There is good agreement between this refinery model for Arab Medium Crude and the aggregate consumption in the US refining sector (in 2006) [59,62].

No data were found on the time-varying efficiency of oil refining. In the absence of data, the model assume refinery energy consumption per unit of energetic throughput decreased by 2.5% per 10 year

period in the Low case and 5% per 10 year period in the High case. Thus, a refinery consumption multiplier is included in the model (in the High case equals 1.25 in 1955, 1.2 in 1965, etc.).

4. Results and Discussion

Energy inputs and outputs for California oil production are presented in Table 4 for the low case (in PJ per year). Calculated values of NER and EER are plotted in Figure 8. Error bars represent low and high case assumptions, markers represent average of low and high cases. Point of extraction EROI drops significantly over the modeled time period, from over 60 to ≈ 5 . Also, full fuel cycle NER/EROI declined from ≈ 6.5 to 3.5, while EER dropped from 12 to 4.25. Both of these trends illustrate the decreasing energetic returns from oil extraction as depletion progresses. This should be expected given the trends observed above (e.g., increasing water cut, increasing fraction of energy consumed in steam generation).

Note the significant difference between values measured at the point of extraction (POE) and values measured over the entire fuel cycle. This divergence is due to the fact that refining is a large and fairly consistent consumptive sector, which reduces significantly the ratio between the numerator (outputs) and the denominator (total consumption).

These trends reflect on the balance between quality factors and technical efficiencies, as discussed above. As the quality factors declined in favorability in the California oil industry (e.g., more water must be lifted for each unit of oil produced), the increase in technical efficiencies did not fully compensate for these reductions in quality. This trend caused the energetic returns to oil extraction to decline significantly over the modeled time period. The largest portion of this effect is due to energy consumption for TEOR, seen in x_{c1} and most of x_{e1} in Table 4.

Table 4. Energy flows in the California oil industry 1955–2005, low case (PJ/y).

Flow	1955	1965	1975	1985	1995	2005
F_i	1011	2298	1928	2488	1778	1446
F_c	1011	2256	1814	2342	1778	1446
F_r	943	2110	1677	2171	1654	1346
$F_{f,oil}$	942	2109	1676	2170	1654	1345
$F_{f,e-}$	0	0	0	12	58	58
$F_{f,gas}$	208	340	210	263	177	230
x_{e1}	7	15	16	169	264	243
x_{r1}	1	1	0	1	0	0
x_{c1}	0	41	114	146	0	0
w_{c1}	4	6	1	0	0	0
x_{e2}	65	148	124	160	114	93
x_{r2}	0	0	0	0	0	0
x_{c2}	68	147	137	171	124	100
x_{inc2}	6	13	11	14	10	8

Figure 8. Estimated energy return ratios for the California oil industry, 1955–2005. Functions used to generate energy return ratios are presented in Table 2, while input data (for low case) are presented in Table 4.

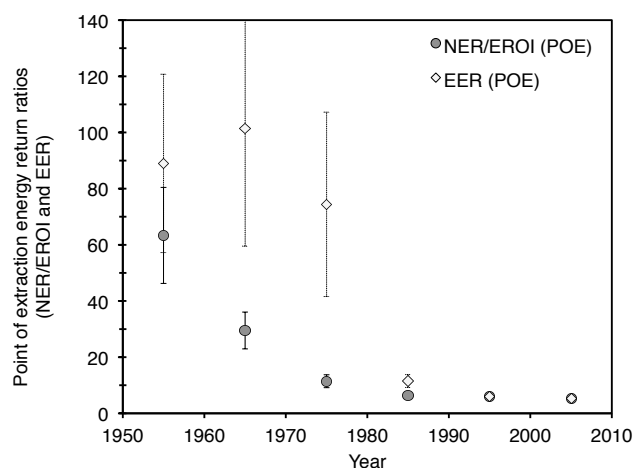

(a) Point of extraction (POE) energy return ratios (excludes refining).

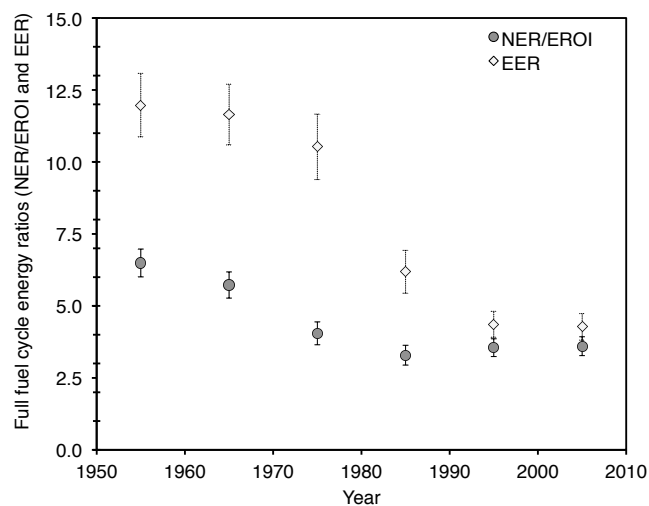

(b) Full fuel cycle energy return ratios (includes refining).

Figure 8 shows a closing of the gap between NER and EER beginning in the mid-1980s. This is due to changing of the primary energy source for California TEOR steam production. Originally, steam for EOR was generated using produced heavy crude. Producers switched to natural gas for generating steam, thus the internal energy use x_{c1} drops significantly by 1985, reducing the gap between NER and EER. TEOR ceased to be a largely self-fueled process at this time.

Useful information can be obtained by comparing the values of NER and EER for a given process. Such comparisons illustrate how much of a conversion and extraction process is self-fueled. For example, in previous studies of oil shale development in the Green River formation of Colorado, Brandt [43,63] found that EER and NER varied greatly for in situ and mine-and-retort oil shale extraction schemes. This is because the oil shale extraction processes studied were fueled primarily by the shale inputs to the retorting process. Similar considerations applied to the largely self-fueled early TEOR operations. These operations were less energy efficient, but because only produced crude was being consumed, this did not result in an additional draw on other resources such as natural gas. This self use reduces the endowment of oil and the net output per unit of capital investment, but will not affect other energy sectors appreciably. Self use also results in environmental impacts (e.g., GHGs per unit of energy output).

The uncertainty in model results is significant. EROI values actually achieved in the California oil industry over time are fundamentally unobservable: many of the required data inputs are not publicly available or were likely even lost over time due to neglect. This lack of data causes fundamental difficulties in assessing the uncertainty. One conclusion is that this uncertainty is uneven in the above model functions: detailed operations data are available at the field level in CDC-DOGGR statistics, while little data are available on technical efficiencies over time. Again, these data were not required to be reported by regulatory bodies and were therefore never publicly documented.

Despite these uncertainties, this type of analysis has significant value. Because the model relies on bottom-up data, such as m³ of water lifted, additional understanding of depletion effects can be generated compared to top-down EROI assessments based on aggregated economic data. In theory, this allows diagnosis of the most important effects of depletion, and industry effectiveness in responding to these depletion impacts.

The global impacts of these forms of depletion on the energy efficiency and environmental impacts of oil extraction are still poorly understood. At this time of rapid expansion of low-quality oil resources such as the Canadian tar sands, this is a troublesome gap in knowledge. Given the size and energy intensity of oil extraction and refining operations, the impacts of such changes on global environmental impacts are likely large.

Acknowledgements

Charles Hall and Richard Sears provided detailed comments on the methods used here. Bryan Sell and Jon Freise provided numerous helpful comments on the manuscript, as well as additional data on drilling energy intensity. Members of the Antique Caterpillar Machinery Owners Club generously provided historical technical specifications for Caterpillar drill rig engines from the 1950s and 1970s. Additionally, helpful comments on an earlier version of this work were provided by Tad Patzek, Alex Farrell and Richard Norgaard at UC Berkeley.

References

1. Farrell, A.E.; Brandt, A.R. Risks of the oil transition. *Environ. Res. Lett.* **2006**, *1*, 014004.
2. Brandt, A.R. Testing hubbert. *Energy Policy* **2007**, *35*, 3074–3088.
3. Deffeyes, K.S. *Hubbert's Peak: The Impending World Oil Shortage*; Princeton University Press: Princeton, NJ, USA, 2001; p. 208.
4. Campbell, C.J.; Laherrere, J. The end of cheap oil. *Sci. Am.* **1998**, *278*, 78–83.
5. Hall, C.A.S.; Cleveland, C.J. Petroleum drilling and production in the United States: Yield per effort and net energy analysis. *Science* **1981**, *211*, 576–579.
6. Cleveland, C.J. Net energy from the extraction of oil and gas in the United States. *Energy* **2005**, *30*, 769–782.
7. Rintoul, W. *Spudding in: Recollections of Pioneer Days in the California Oil Fields*; California Historical Society: San Francisco, CA, USA, 1976.
8. Rintoul, W. *Drilling through Time: 75 Years with California's Division of Oil and Gas*; California Dept. of Conservation Division of Oil and Gas: Sacramento, CA, USA, 1990.
9. API. *Petroleum Facts and Figures: Centennial Edition*; American Petroleum Institute: New York, NY, USA, 1959.
10. API. Basic Petroleum Data Book: Petroleum Industry Statistics. *Basic Petroleum Data Book*; American Petroleum Institute: Washington, DC, USA, 2004; Volume 24.
11. CDC-DOGGR. *California Oil and Gas Fields, Volumes I–III*. Technical report. California Department of Conservation, Division of Oil, Gas, and Geothermal Resources: Sacramento, CA, USA, 1982–1998.
12. Rintoul, W. *Oildorado: Boom Times on the West Side*; Valley Publishers: Fresno, CA, USA, 1978.
13. Rintoul, W. *Drilling Ahead: Tapping California's Richest Oil Fields*, 1st ed.; Valley Publishers: Santa Cruz, CA, USA, 1981.
14. CDC-DOGGR. *Summary of Operations: California Oil Fields*. Technical report. California Department of Conservation, Division of Oil and Gas, and Geothermal Resources: Sacramento, CA, USA, 1966.
15. CCCOGP. *Annual Review of California Oil and Gas Production*. Technical report. Conservation Committee of California Oil and Gas Producers: Bakersfield, CA, USA, 1994.
16. Dennison, W.J.; Taback, H.; Parker, N. *Emissions Characteristics of Crude Oil Production Operations in California*. Consultant report KVB72-5810-1309ES. California Air Resources Board: Sacramento, CA, USA, 1983.
17. Norton, J.F. *A Report to the California Energy Commission: The Options for Increasing California Heavy Oil Production: Final Report*; Radian Corporation: Sacramento, CA, USA, 1981.
18. Henwood, M.I. *Feasibility and Economics of Cogeneration in California's Thermal Enhanced Oil Recovery Operations*; California Energy Commission, Assessment Division: Sacramento, CA, USA, 1978.
19. CDC-DOGGR. *2003 Annual Report of the State Oil & Gas Supervisor*. Technical report. California Department of Conservation, Division of Oil, Gas and Geothermal Resources: Sacramento, CA, USA, 2004.

20. Production is lightly taxed in California (e.g., no mineral severance tax), the reduction in California oil production is not likely a major driver of California's recent budget difficulties. The production decline since peak production amounts to ≈ 200 Mbbl/y, which if valued at 100 \$/bbl would equal $\approx 1\%$ of California's total economic output.
21. CDC-DOGGR. *2008 Annual Report of the State Oil & Gas Supervisor*. Technical report. California Department of Conservation, Division of Oil, Gas and Geothermal Resources: Sacramento, CA, USA, 2009.
22. ISO. *ISO 14040: Environmental Management—Life Cycle Assessment—Principles and Framework*; International Organization for Standardization: Geneva, Switzerland, 2006.
23. ISO. *ISO 14044: Environmental Management—Life Cycle Assessment—Requirements and Guidelines*; International Organization for Standardization: Geneva, Switzerland, 2006.
24. Herendeen, R.A. Net Energy Analysis: Concepts and Methods. In *Encyclopedia of Energy*, Cleveland, C.J., ed.; Elsevier: Amsterdam, The Netherlands, 2004; Volume 4, pp 283-289 .
25. CERI. *Net Energy Analysis: An Energy Balance Study of Fossil Fuel Resources*. Technical report. Colorado Energy Research Institute: Golden, CO, USA, 1976.
26. Pehnt, M. Dynamic Life Cycle Assessment (LCA) of renewable energy technologies. *Renew. Energy* **2006**, *31*, 55–71.
27. Levasseur, A.; Lesage, P.; Margni, M.; Descheacnes, L.; Samson, R. Considering Time in LCA: Dynamic LCA and its application to global warming impact assessments. *Environ. Sci. Technol.* **2010**, *44*, 3169–3174.
28. Mendivil, R.; Fischer, U.; Hirao, M.; Hungerbuhler, K. A new LCA methodology of technology evolution (TE-LCA) and its application to the production of ammonia (1950–2000). *Int. J. Life Cycle Assess.* **2006**, *11*, 98–105.
29. Farrell, A.; Plevin, R.J.; Turner, B.T.; Jones, A.D.; O'Hare, M.; Kammen, D.M. Ethanol can contribute to energy and environmental goals. *Science* **2006**, *311*, 506–508.
30. Cleveland, C.J. Energy quality and energy surplus in the extraction of fossil fuels in the US. *Ecol. Econ.* **1992**, *1992*, 139–162.
31. Gever, J. *Beyond Oil: The Threat to Food and Fuel in the coming Decades*, 3rd ed.; University Press of Colorado: Niwot, CO, USA, 1986.
32. Hall, C.A.S.; Cleveland, C.J.; Kaufmann, R. *Energy and Resource Quality: The Ecology of the Economic Process*; Wiley: New York, NY, USA, 1986.
33. Spitzley and Keolian outline more than 10 energy return ratios that have been used previously. These ratios differ in system boundaries included, in the quantity of interest, and in the inclusion or exclusion of various energy types (e.g., fossil energy return ratios that measure the leveraging of fossil energy streams in renewable energy systems). In many published studies, authors fail to specify exactly which energy return ratio is used.
34. Spitzley, D.V.; Keoleian, G. *Life Cycle Environmental and Economic Assessment of Willow Biomass Electricity: A Comparison with other Renewable and Non-Renewable Sources*. Technical Report CSS04-05R. University of Michigan: Ann Arbor, MI, USA, 2004.

35. Large amounts of data are available from the *California Department of Conservation—Department of Oil, Gas, and Geothermal Resources* (CDC-DOGGR). Databases contain well-level information from the late 1970s to the present, and field-level data are available in annual reports dating to 1915.
36. CDC-DOGGR. *Summary of Operations and Annual Report of the State Oil & Gas Supervisor (Various)*. Technical report. California Department of Conservation, Division of Oil, Gas and Geothermal Resources: Sacramento, CA, USA, 1955–2005.
37. Caterpillar. Drilling rig repower. Brochure, Caterpillar Inc.: Peoria, IL, USA, 2003. <http://catoilandgas.cat.com/cda/files/823409/7/LEDW3153.pdf>
38. Caterpillar. Caterpillar D397 Twelve Cylinder Specification Sheet. (Date illegible, approximately 1950).
39. EIA. *Electric Power Annual 2007*. Technical report. Energy Information Administration: Washington, DC, USA, 2009.
40. Schmidt, P.F. *Fuel Oil Manual*, 4th ed.; Industrial Press: New York, NY, USA, 1985.
41. Cheyenne Drilling Inc. Personal communication with staff of Cheyenne Drilling on energy consumption during drilling, 2006.
42. Cheyenne Drilling Inc. Drilling rig information, rig 1. Web page, Cheyenne Drilling, 2006.
43. Brandt, A.R. Converting oil shale to liquid fuels: Energy inputs and greenhouse gas emissions of the Shell in situ conversion process. *Environ. Sci. Technol.* **2008**, *42*, 7489–7495.
44. Azar, J.; Robello, G. *Drilling Engineering*; PennWell Publishers: Tulsa, OK, USA, 2007.
45. PSAC. *2001/2002 Well Cost Study*. Technical report. Petroleum Services Association of Canada: Calgary, AB, Canada, 2000.
46. PSAC. *2002 Well Cost Study*. Technical report. Petroleum Services Association of Canada: Calgary, AB, Canada, 2001.
47. PSAC. *2005 Well Cost Study*. Technical report. Petroleum Services Association of Canada: Calgary, AB, Canada, 2005.
48. Gow, S. *Roughnecks, Rock Bits and Rigs: The Evolution of Oil Well Drilling Technology in Alberta, 1883–1970*; University of Calgary Press: Calgary, AB, Canada, 2005.
49. Smil, V. *Prime Movers of Globalization: The History and Impact of Diesel Engines and Gas Turbines*; The MIT Press: Cambridge, MA, USA, 2010.
50. Caterpillar Inc. Caterpillar D399 Marine Generator Set - Technical Specifications, 1980. <https://marine.cat.com/cda/files/1014636/7/Spec+Sheet+-+Cat+D399+Genset.pdf>
51. Horvath, A. Construction materials and the environment. *Annu. Rev. Environ. Resour.* **2004**, *29*, 181–204.
52. Brennan, J.R.; Vance, W.M., Section 9.17 - Oil Wells. In *Pump Handbook*, 3rd ed.; Karassik, I.J., Messina, J.P., Cooper, P., Heald, C.C., Eds.; McGraw Hill: New York, NY, USA, 2001.
53. Lyons, W.C.; Plisga, G.J. *Standard Handbook of Petroleum and Natural Gas Engineering*, 2nd ed.; Gulf Professional, Imprint of Elsevier: Burlington, MA, USA, 2005.
54. Takacs, G. *Sucker-Rod Pumping Manual*; PennWell Books: Tulsa, OK, USA, 2003.
55. Cited values of η_t ranges from 85% to 93%, while η_l ranges from 38% to 94% [54]. The lowest values were due to rubbing of the pump string against well casing in deviated wells [54]. I assume η_m ranges from 80-90%.

56. Ayres, R.U.; Ayres, L.W.; Pokrovsky, V. On the efficiency of US electricity usage since 1900. *Energy* **2005**, *30*, 1092–1145.
57. Green, D.W.; Willhite, G.P. *Enhanced Oil Recovery*; Henry L. Doherty Memorial Fund of AIME, Society of Petroleum Engineers: Richardson, TX, USA, 1998.
58. Burger, J.; Sourieau, P.; Combarnous, M. *Thermal Methods of Oil Recovery*, 3rd ed.; Editions Technip, Gulf Publishing Company: Houston, TX, USA, 1985.
59. Brandt, A.R.; Unnasch, S. Energy intensity and greenhouse gas emissions from California thermal enhanced oil recovery. *Energy & Fuels* **2010**, *24*, 4581–4589.
60. CDC-DOGGR. *Annual Report of the State Oil & Gas Supervisor*. Technical report. California Department of Conservation, Division of Oil, Gas and Geothermal Resources: Sacramento, CA, USA, 2005.
61. Keesom, W.; Unnasch, S.; Moretta, J. *Life Cycle Assessment Comparison of North American and Imported Crudes*. Technical report. Jacobs Consultancy and Life Cycle Associates for Alberta Energy Resources Institute: Chicago, IL 2009.
62. Wang, M.Q. *Estimation of Energy Efficiencies of US Petroleum Refineries (Plus Associated Spreadsheet)*. Technical report. Center for Transportation Research, Argonne National Laboratory: Argonne, IL, USA, 2008.
63. Brandt, A.R. Converting oil shale to liquid fuels with the Alberta taciuk processor: Energy inputs and greenhouse gas emissions. *Energy Fuels* **2009**, *23*, 6253–6258.

© 2011 by the author; licensee MDPI, Basel, Switzerland. This article is an open access article distributed under the terms and conditions of the Creative Commons Attribution license (<http://creativecommons.org/licenses/by/3.0/>.)

Article

Analysis of the Energy Return on Investment (EROI) of the Huge Daqing Oil Field in China

Yan Hu ^{1,*}, Lianyong Feng ¹, Charles C.S. Hall ² and Dong Tian ¹

¹ Office 623, School of Business Administration, China University of Petroleum (Beijing), Beijing 102249, China; E-Mails: fengly@yahoo.cn (L.F.); grassfour@126.com (D.T.)

² Graduate Program in Environmental Science, College of Environmental Science and Forestry, State University of New York, Syracuse, NY 13210, USA; E-Mail: chall@esf.edu

* Author to whom correspondence should be addressed; E-Mail: yanzi_050605@yahoo.cn (Y.H.); Tel.: +86-010-13811753828.

Received: 5 February 2011; in revised form: 2 August 2011 / Accepted: 28 November 2011 /

Published: 30 November 2011

Abstract: In China there has been considerable discussion of how one should express the efficiency of energy conversion and production. Energy return on investment (EROI) can be useful for this because its methodology is based on outputs and inputs. Unfortunately, similar to the rest of the world, most of the data available for assessing energy gains and costs for oil and gas in China has to be derived from economic costs and revenues for oil fields. In this paper we derive a first EROI for China based on using this approach and the existing data for production of crude oil and natural gas for the Daqing oil field, the largest oil field in China. We estimate that its $EROI_{std}$ expressed as heat equivalent was 10:1 in 2001 but has declined to 6.5:1 in 2009. Based on this trend we project that the $EROI_{std}$ will decline to 4.7:1 in 2015, and the net energy from the field will be decreasing substantially. The calculations have some errors because of incomplete data, and if various externalities are taken into account, the EROI of this oil field would be lower than our present estimates. The trends of EROI and net energy suggest that the Daqing oil field will face more difficulty in the future which can not be overcome by government fiat.

Keywords: EROI; Daqing oil field; net energy

1. Introduction

In traditional economic analyses there are two types of profits and returns from economic systems: “gross” and “net”. These are used routinely in such assessments as the gross national product (GNP) and the net national product (NNP), and in gross income and net profit in financial analyses. Any economic system, from enterprises to countries, must consider not only the total or gross output or sales but also the net output (profit) for their decision making.

Curiously the same concept is almost completely ignored by most researchers in the energy field. This has been true even though the concept has a long history in energy analysis. For example, Cottrell [1] uses the concept of net energy production, which he calls energy surplus. Howard Odum [2] writes explicitly about the importance of gross vs net energy output. Hall *et al.* [3] and Cleveland *et al.* [4] put forward a related concept, energy return on investment (EROI), as a more intuitive description of net energy. Although the concept seems easy enough (energy output divided by energy inputs used in the same energy production process), it is actually very complex in practice. It can be used in at least two ways: firstly for getting energy itself, e.g., the normal process of oil exploration, development and production from an oil field or province, and secondly more generally for the energy required to maintain and develop an economy or society.

So far EROI has not been undertaken according to any unified standards because it has involved many uncertain factors and many independent and sometimes arbitrary judgments, as discussed in Murphy *et al.* [5] in this journal special issue. This has contributed to different results from different analyses, although nearly all analyses show that: the EROI of conventional oil, gas and coal is high but decreasing, and the EROI of oil shale, liquefied coal and biofuels is much lower. In 1970 the oil and gas industry in the United States used the energy equivalent of one barrel of oil to produce about 30 barrels of oil, so the EROI was 30:1 [6]. Today, for the U.S. the EROI has dropped to approximately 10:1 while the global value has declined from 35:1 in 1999 to 18:1 in 2006 [7].

EROI has additional relevance to the concept of peak oil. Many geologists and economists are optimistic that technology can solve the peak oil problem, so they disagree, more or less, with the concept. The truth is that depletion and technology are in a race, and there is no obvious way to distinguish which is the winner without empirical analysis of particular situations. Technology can indeed sustain or increase output, but it usually requires substantial energy investments to do so. In a sense the change in EROI evaluates who is winning in the race between oil depletion and technological progress. That assessment gives more credibility to peakoilism [8].

1.1. Daqing Oil Field and Its Important Role in China

The discovery of Daqing oil field in 1959 made China an oil-rich country. The Daqing oil field is by far China’s largest oil field to date (Figure 1), and is also among the world’s largest oil fields. It has obviously made a tremendous contribution to China’s oil industry and maintained a long-term stable yield. Since it has recently shown some signs of faltering, this seems like a good time to ask if EROI can add anything to our understanding of this important oil field.

Figure 1. The Location of Daqing oil field. It is in the Hei Longjiang province and in the northeast of China. The red arrow points to the field. Individual oil fields are much smaller than the regional ellipses. Source: EIA, U.S. Energy Information Administration [9].

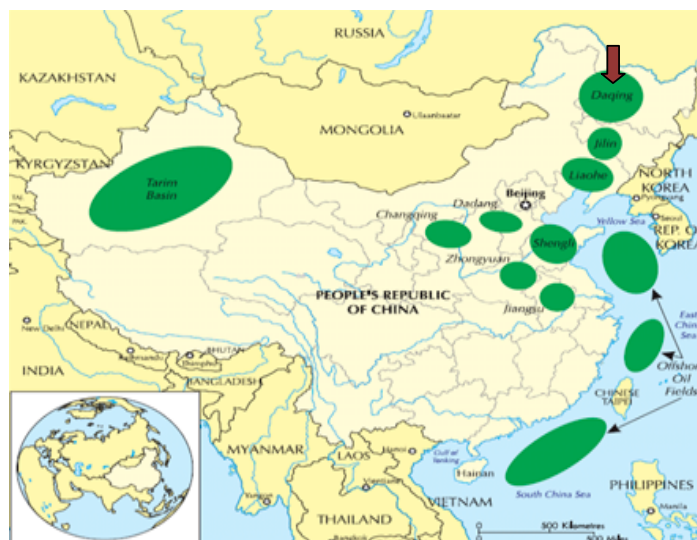

The development of Daqing oil field can be divided into four phases (Figure 2).

Figure 2. Oil production of the Daqing oil field (blue line) in million barrels per year, and its proportion of total national production (red bars). Oil production data are from the Daqing oil field official website, national total production (1960–2007) from China’s Energy Statistical Yearbook 2009, 2008 and 2009 and from the Journal of International Oil Economy in China. Note: natural gas production is much less than oil, and the Daqing oil field website converts gas into toe and includes it in oil production.

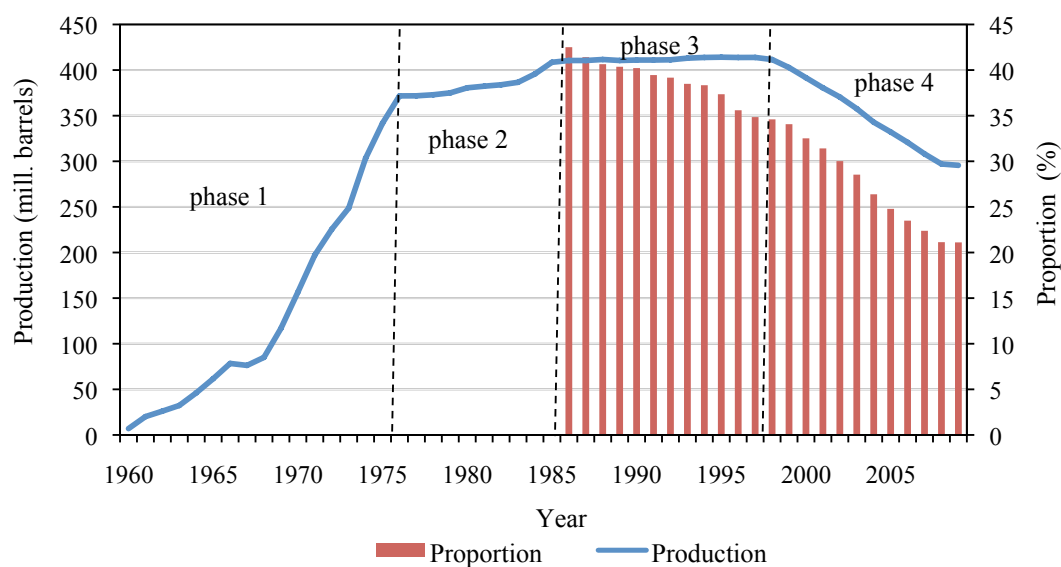

In the first phase (1960–1976), crude oil production increased rapidly, to 371.7 million barrels per year in 1976.

In the second phase (1977–1986), the oil field was in a moderate “containing-water” stage and had stable production for a decade. By increasing the pressure of the water beneath the oil and increasing pressure among a series of different strata, annual production increased continuously, from 371.8 million barrels in 1977 to 410.5 million barrels in 1986.

In the third phase (1987–1997), which was the second stable production decade of the Daqing oil field, the field began to become saturated with water. While the quantity of additional water in the field was increased gradually, it became more difficult to maintain a stable yield. Therefore, China then used advanced technology which aimed to improve the output of old wells, and to increase the productive potential of the field’s low-to-moderately permeable strata. Consequently, the annual production increased from 410.5 million barrels in 1987 to 413.9 million barrels in 1997. At this phase, Daqing oil field experienced a “peak plateau” period at about 410 million barrels per year. The proportion of this one field in the national total production declined from 41.4% in 1987 to 34.8 % in 1997.

In the fourth phase (1998–2009), the oil production began declining. The production of the Daqing oil field has been decreasing since the peak of 410 million barrels to 295.6 million barrels in 2009. In this period, oil production was maintained and water content was controlled mainly by increasing the pressure of the water beneath the oil and the use of polymer flooding technology to maintain oil production and control water content. The proportion of the Daqing field in national production also declined, from 34.6% in 1998 to 21.1% in 2009. One can note that, even at peak usage, there was less than half a barrel produced per year per Chinese citizen.

2. EROI Methodology

2.1. EROI and Similar Indexes in China

There are several existing indexes of efficiency used in China whose equations are somewhat similar to EROI. These include “energy macro-efficiency”, “productivity”, “energy physical efficiency”, and “efficiency of energy conversion”. Just like EROI, each of them evaluates relations of “output” and “input”. However, they are essentially different from EROI.

Energy intensity, one important index of “energy macro-efficiency” from the national point of view, regards GDP as output, and energy consumption as input (equation 1). A higher economic efficiency causes a lower energy intensity. It emphasizes the relation of energy consumption to the economy, and reflects from the national perspective the dependence of economic well-being on energy.

$$\text{Energy intensity} = \text{energy consumption} / \text{GDP} \quad (1)$$

Productivity, like energy macro-efficiency, uses the ratio of output and input to evaluate production capacity from a macro-view (equation 2). Output is gross (or net) national production and input is based on human, material or financial resources or a combination of these resources.

$$\text{Productivity} = \text{commodities output} / \text{human labor (or capital or resources or other)} \quad (2)$$

Energy physical efficiency is generally assessed as energy consumption per unit product (equation 3). This index focuses mainly on energy utilization per unit of energy-intensive products, such as total energy consumption per unit steel production. It is especially suitable for the comparison between enterprises which have the same production structure, and the same level of equipment and management. The similarity of this index and EROI is energy consumption per unit of production, although they are reciprocal.

$$\text{Energy physical efficiency} = \text{energy consumption} / \text{production of product} \quad (3)$$

Efficiency of energy conversion, is the ratio of output of a particular kind of energy to the energy inputs for processing and conversion in the same period (equation 4). This analysis focuses on the levels of equipment and the technology of conversion and management used. In recent years, this index for petroleum refining and coking has been maintaining at 95% and above. The same ratio for electricity generation by power stations fluctuates about 39%.

$$\text{Efficiency of energy conversion} = \text{energy output after conversion} / \text{energy input for that conversion} \quad (4)$$

Most of these ratios are applied at the level of the entire economy, the nation or some other large entity. EROI is different because it examines the effectiveness of obtaining energy itself, assesses the energy gain relative to energy costs, and assesses how the quality of the energy base is changing over time, including changes in net energy gains from energy resources. It is usually applied at the level of a particular field, region or political unit. Importantly, it allows ranking different fuels and examining trends in the relation of technology and depletion over time. We believe that EROI should become one of the important components of China's official energy statistics like the above four. There may be less enthusiasm for governments to maintain such statistics because, unlike the other indices, it often declines over time, which is in opposition to the concept of continual technological progress which the government likes to project.

2.2. Static and Dynamic Process

EROI analysis can be used to derive the energy relations at one point in time, but it usually generates more interesting results when it is used to evaluate the dynamic productivity of an energy supply process, that is its behavior over in time. A discussion about the performance of a process usually starts from a static state, often for the present, and then develops from there.

A difficulty is assigning the time period when inputs generate outputs. Usually the energy output data should be for the same period as that of energy input. Some of the fuel produced at a given time, however, came from investments long ago, and today's investments are likely to be generating fuel well into the future. In actuality much of today's costs are for immediate production (such as natural gas used to pressurize or pump an oil field), some is used for replacing equipment that has worn out over past years, and some is used to find or exploit new oil or gas. Since different depreciation methods are used for different fixed assets, we can't simply put total fixed assets into "energy inputs". However, we can get the total depreciation from the Daqing oil field. In addition, while detailed

records of energy consumption are kept, these data are expressed in terms of money, such as total cost and expense during the processing year. They must be multiplied by some index of energy intensity if we want to use them in an EROI formula. This gives a straightforward assessment of energy in physical units.

2.3. Approaches to EROI

Our initial method of deriving EROI is to compare energy outputs and inputs in thermal units. The formula is as follows:

$$EROI = \frac{\sum_{i=1}^n E_i^O}{\sum_{i=1}^n E_i^I} \quad (5)$$

E_i^O and E_i^I respectively indicate thermal equivalents of energy outputs and inputs for the period considered. Thermal equivalents are based on the first law of energy conservation, *i.e.*, that all energies can be measured by their final conversion to heat. However, the ability to heat water is just one attribute of energy. Different characteristics and ways of using energy can contribute to different power generation of the same thermal energy [10]. We believe it is necessary, in addition, to apply a quality factor and revise EROI because of different energy qualities. Howard Odum was among the first to propose the concept of energy quality and defined it as relative economic utility among different energy types [11]. The revised formula is as follows:

$$EROI = \frac{\sum_{i=1}^n \lambda_i E_i^O}{\sum_{i=1}^n \lambda_i E_i^I} \quad (6)$$

where λ means the quality factor. This revised EROI can better reflect the real supply of useful energy to society.

The two formulas above are dynamic over time. In one time unit (such as one year), the formula of EROI is as follows:

$$EROI = \frac{\lambda E^O}{\lambda E^I} = \frac{\lambda E^O}{\lambda E_{Direct} + M_{Indirect} \times E_{ins}} \quad (7)$$

where λE^O is joules of all energy outputs expressed in the same units, λE^I and λE_{Direct} , respectively, represent total input and direct (on site) input of different kinds of energy, λ is a quality factor representing the “potency” of the different forms of energy used, $M_{Indirect}$ expresses indirect inputs, which are usually derived from money spent and its energy intensities per monetary unit, E_{ins} .

In theory, energy intensity should be based on numbers from the entire (national) oil industry or related to the national oil and gas supply sectors—in other words, it should be for those sectors supplying the indirect inputs such as steel forms or drill bits. It is difficult to calculate this, however, because of a lack of data on GDP and energy consumption for specific sectors of the Chinese

economy. In the Chinese data, the sectors for extraction of petroleum and natural gas are categorized simply as belonging to “industry”. Therefore, we must use more general conversion factors, those for the energy intensity of all industry. These can result in certain errors in the calculation of energy inputs to EROI but are more accurate than using values for the economy as a whole. We were able to get data for GDP and energy use to derive a time series of energy intensity for all industry (Figure 3). We eliminate the effect of inflation by using each year’s ratio [7].

Figure 3. Energy intensity for all industry in China (data are from China Energy Statistical Yearbook 2009 [12]). The economic data is not corrected for inflation. CE represents coal equivalent.

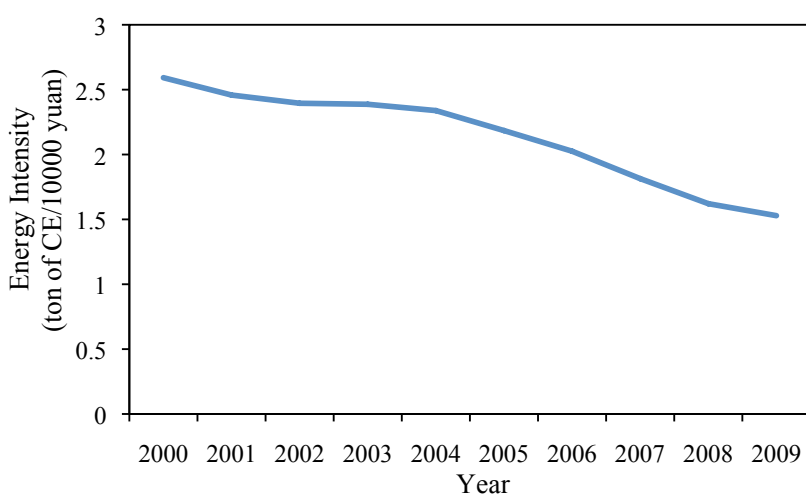

In order to get quality-corrected energy outputs and direct energy inputs, we used the Divisia index, which basically makes the assumption that the quality of a fuel is related to its relative price per heat unit [5][13][14]. While price is not the perfect predictor of energy quality, it is better than no correction and easy to get. This is most important here with respect to the quality differences between oil, natural gas and other energy [15]. The Divisia index which corrects for price changing and from one year to the next is expressed as:

$$\ln E'_t - \ln E'_{t-1} = \sum_{n=1}^k \left[\left[\frac{P_{nt} E_{nt}}{2 \sum_{n=1}^k P_{nt} E_{nt}} + \frac{P_{nt-1} E_{nt-1}}{2 \sum_{n=1}^k P_{nt-1} E_{nt-1}} \right] (\ln E_{nt} - \ln E_{nt-1}) \right] \quad (8)$$

where P is the price of n different types of fuels and E is the final consumption of energy (joules) for each fuel type.

Since most kinds of energy originate from solar energy, all energies could be weighed relative to solar energies, which can make different kinds of energy comparable [16]. Although it seems to be effective, there are some limitations for its application to EROI analysis of oil and natural gas extraction since it is not quite clear how much sunlight goes into making a heat unit of oil vs. gas. It is rarely used in energy analysis.

3. EROI of Daqing Oil Field

3.1. Boundary

Selecting the appropriate boundaries for EROI analysis is a crucial step. The use of different boundaries in the past based on different research objectives have resulted in very different results, even when applied to the same energy resource. According two-dimensional framework for EROI analysis advocated by Murphy *et al.* [5], one dimension is “what do we count as energy output?” and is depicted with the three system boundaries; other dimension is “what do we count as inputs?” and is divided five levels.

This paper discusses the process of exploration and development, and production, and the output is crude oil and natural gas from this process. That is we choose the system boundary 1, which is extracted unprocessed energy described by Murphy *et al.* [5]. According to the Daqing oil field statistics, we convert natural gas output into oil equivalents. Considering inputs, we divide them into two levels. The first level is direct level, which just has direct energy input given in physical units. The second level is indirect level, which include direct and indirect energy input (total energy input). Besides that, we make the quality-corrected for direct energy input, and then we can get the total energy input of quality-corrected heat equivalents. Therefore, this paper provides the two-dimensional framework (Table 1), which is similar with the protocol [5] and is appropriate to the type of Daqing oil field data and for the oil and gas industry. In the Table 1, the subscript “1” means the boundary for system boundary 1, while the “d” refers to direct energy inputs. $EROI_{std}$ represents the direct and indirect energy inputs and outputs from boundary 1. The “Qd” refers to direct energy input of quality-corrected heat equivalents, while the “Qstd” refers to quality-corrected of “ $EROI_{std}$ ”.

Table 1. Two-dimensional framework for EROI analysis

Level	Energy Inputs	Heat Equivalents	Quality-corrected Heat Equivalents
Level 1	Direct energy inputs	$EROI_{1,d}$	$EROI_{1,Qd}$
Level 2	Indirect energy inputs	$EROI_{std}$	$EROI_{1,Qstd}$

3.1.1. Energy Outputs

The data of the Daqing oil field output was derived from the official web site for the field. This output was converted to heat units using the values in Table 2. Then, we can get energy output as heat equivalents (Figure 4).

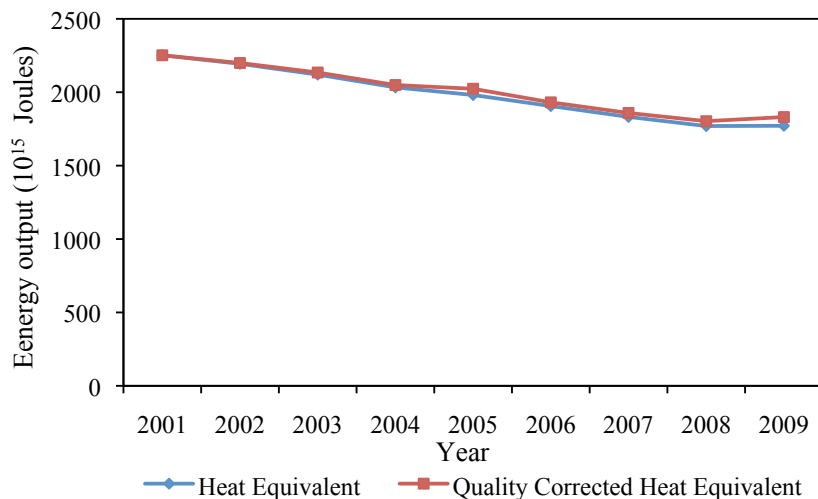
Figure 4. Energy output expressed as heat equivalent and quality-corrected heat equivalent.

However, joule unit measurements are not always equal; for example, the utility of a heat unit of electricity is different from that of a heat unit of coal. Because of this, we also convert all energy units to a common unit by using Divisia index for weighing the difference in quality amongst energy types. By calculating the Divisia index, energy prices are the key factor.

We are able to get accurate crude oil prices for the Daqing oil field every year [17-26]. The National Development and Reform Commission publishes adjusted gas prices several times over the course of nine years for different using categories. We derived the annual average gas price for industries [27]. Then, we got energy output after correcting the heat equivalent values for quality (Figure 4).

The difference between quality-corrected and non-corrected energy output is very small (Figure 4). The first reason for this is that natural gas production is small compared to oil production (4.36% in 2001, and 5.57% in 2009; Figure 5). The gas production expressed as joules gives only a very small correction. The second reason is that natural gas prices, which are lower than the true market prices, are controlled by the National Development and Reform Commission.

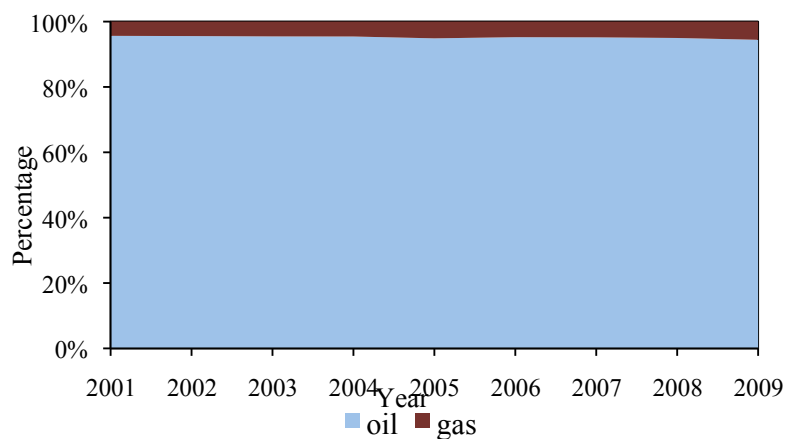
Figure 5. Oil and Gas Joules Percentage in the Total Energy Output

3.1.2. Direct Energy Inputs

Direct input, is given in the Daqing oil field in physical units (ton or kwh), and consists of oil for self-use, gas for self-use, gasoline, diesel, and electricity (Table 3). Some of the direct inputs, such as water, cannot be defined in energy terms, so we ignore them. The input was also expressed in quality-corrected terms using the same Divisia method as for energy output (Figure 6). The maximum percentage difference in quality-corrected heat equivalents compared to heat equivalents is only 3.8%. The gasoline and diesel price comes from pricing policy of NPRC, which we use to calculate annual average price. Electricity price is based on 0.572 yuan/Kwh from 2001 to 2008 and 0.595 yuan/Kwh in 2009.

Table 2. Conversion factors from physical units to thermal units. Data are from China Energy Statistical Yearbook 2009 [12].

Energy	Average Calorific Value
Crude Oil	41.8 M joule/kg
Natural Gas	38.9 M joule/cu. m
Raw Coal	20.9 M joule/kg
Gasoline	43.1 M joule/kg
Diesel	42.7 M joule/kg
Electricity (in calorific value)	36.0 M joule/kWh
Energy	Physical Unit to Coal Equivalent
Raw Coal	0.7143 kgCE/kg

Figure 6. Direct energy inputs to the Daqing oil field in heat equivalents and quality-corrected heat equivalents.

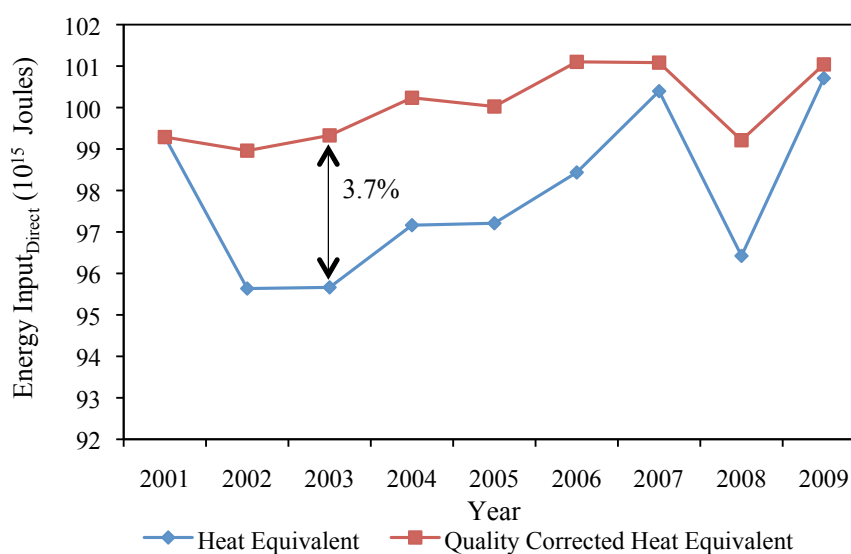

3.1.3. Indirect Energy Inputs

No data was available explicitly for indirect energy input. However, we were able to derive indirect cost as equation 9.

$$E_{Indirect} = (M_{Total} - M_{Direct}) \times E_{ins} \times C_{CE-RC} \times C_{T-J} \quad (9)$$

where $E_{Indirect}$ refers to indirect energy input, M_{Total} and M_{Direct} , respectively, represent total money input and direct money input. E_{ins} is energy intensity for all industry in China and its unit is ton of coal equivalent (CE) of 10^4 yuan, which is 2.4 in the year of 2002 (Figure 3). C_{CE-RC} is the conversion factor from ton of coal equivalent to the ton of raw coal (Table 2). C_{T-J} represents the conversion factor from ton of raw coal to joules (Table 2). Take 2002 data is used as an example to illustrate how to get indirect energy input (Table 3 and Table 4).

Table 3. Money inputs to Daqing oil field in 2002.

Total inputs (raw data)		Unit		As money (10^3 yuan)	
operating costs	11,390,080	10^3 yuan		11,390,080	
depreciation	10,625,160	10^3 yuan		10,625,160	
expenses	3,588,010	10^3 yuan		3,588,010	
Total money input (M_{Total})				25,603,250	
Direct inputs (raw data)	Unit	Price	Unit	As money (10^3 yuan)	
oil for self-use	200.0	10^3 t	1,558,012	yuan/ 10^3 t	312,070
gas for self-use	1.2	10^9 m ³	920,000,000	yuan/ 10^9 m ³	1,130,680
gasoline	36.3	10^3 t	303	yuan/ 10^3 t	11.0
diesel	62.1	10^3 t	273	yuan/ 10^3 t	16.9
electricity	9.8	10^9 kwh	571,700,000	yuan/ 10^9 kwh	5,596,371
Direct money input (M_{Direct})				7,039,149	
Indirect money input ($M_{Indirect} = M_{Total} - M_{Direct}$)				18,564,101	

As the Table 3 showed, we derived indirect monetary costs for Daqing oil field from total monetary costs minus direct monetary costs generated from physical units. Then, we got the indirect energy inputs by converting monetary units into energy units (Table 4).

Table 4. Indirect energy input of Daqing oil field in 2002.

Indirect input	Unit	As Energy
Indirect energy input	10^3 ton of coal equivalent	4,455
Indirect energy input	10^3 ton of raw coal	6,236
Indirect energy input ($E_{Indirect}$)	10^{15} J	130.4

3.1.4. Total Energy Inputs

The second level of EROI analysis includes direct and also indirect energy inputs derived from financial data. These are operation costs, depreciation and expenses for producing oil and gas, which include some direct energy inputs (Table 3). These numbers are not published in a journal or book, but we were able to get them from the financial records of the company. The time series of the energy intensity of Chinese industry are used to convert financial data to joules. Quality-corrected heat equivalent total energy input is shown in Figure 7. There is only a small difference between quality corrected and non-corrected total energy input (or total energy input). This is because the quality difference is even smaller when we compare them with total energy input by heat equivalent (Figure 8).

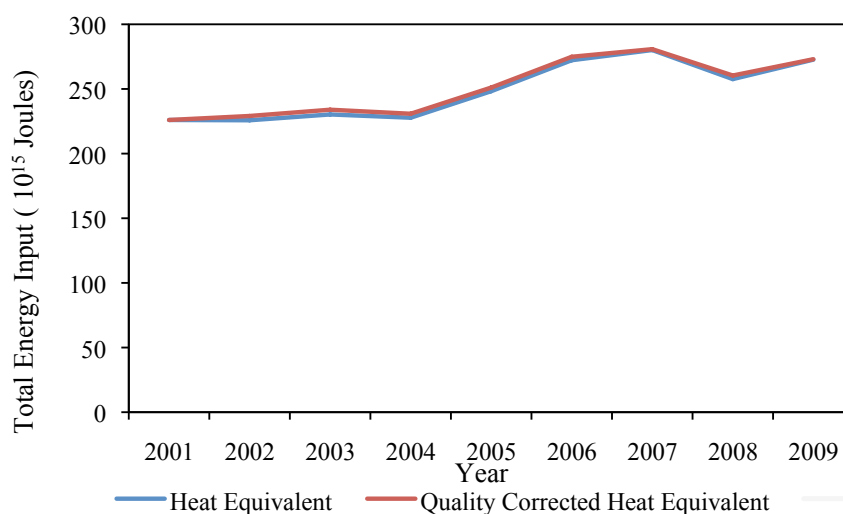
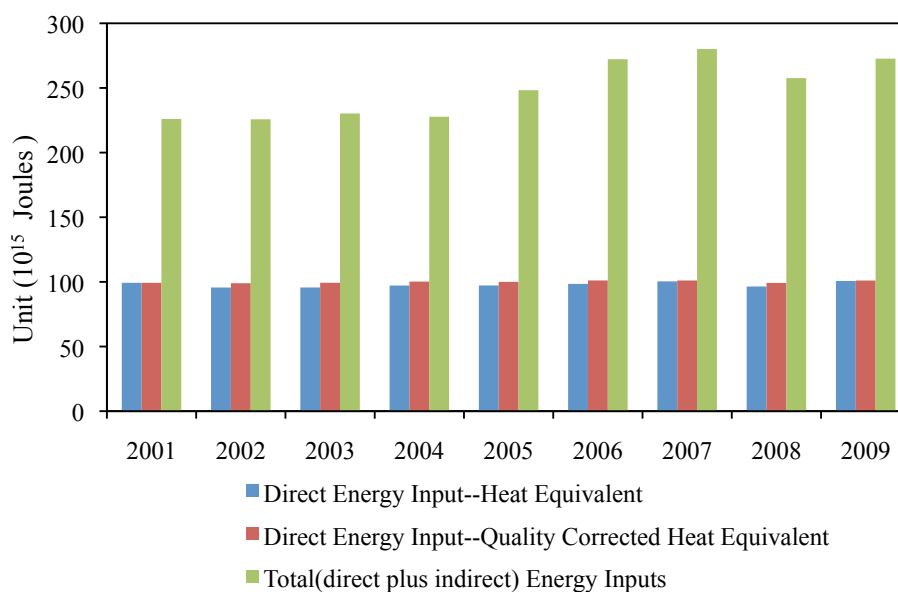
Figure 7. Total energy inputs (heat equivalent and quality-corrected heat equivalent).**Figure 8.** Comparison of direct energy input (heat equivalent and quality-corrected heat equivalent) and total energy inputs (heat equivalent).

3.2. Results

We estimate that the energy return on investment ($EROI_{std}$) for the Daqing oil field decreased from about 10:1 in 2001 to 6.5:1 in 2009 (Table 5 and Figure 9). The EROI derived in four different ways show the same decreasing trends, and EROI derived using heat equivalents is higher than when corrected for quality using the Divisia index. However, EROI expressed as heat equivalents changes less than when outputs and inputs are corrected for quality (Figure 9). In addition, when the indirect costs are not included, the EROI appears higher, which of course is an artifact of the incomplete analysis.

Most often, an EROI analysis is determined by the data available. Since the Daqing oil field does not publish data on pollution we cannot include environmental data as an energy input. For example, the Daqing oil field increases the pressure of the polymers pumped into the ground each year which has large negative impacts on the environment. If the negative externality upon the environment were to be considered, the EROI of the Daqing oilfield would be decreased substantially compared to the value that we present.

Table 5. EROI of Daqing oil field using the four methods given in Table 1.

	2001	2002	2003	2004	2005	2006	2007	2008	2009
EROI _{1,d}	22.7	22.9	22.2	20.9	20.4	19.4	18.2	18.4	17.6
EROI _{1,Qd}	22.7	22.2	21.3	20.3	19.7	18.8	18.1	17.8	17.4
EROI _{stnd}	10.0	9.7	9.2	8.9	8.0	7.0	6.5	6.9	6.5
EROI _{1,Qstnd}	10.0	9.6	9.1	8.8	7.8	6.9	6.5	6.8	6.4

Figure 9. The results of our assessment of the EROI of the Daqing oil field calculated in four different ways. The upper two lines do not include indirect energy costs and are less complete.

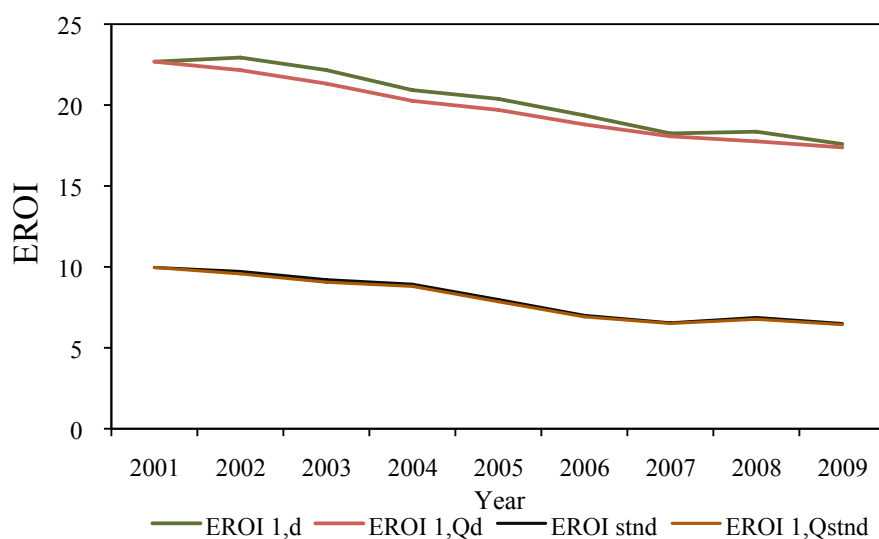

4. Discussion

Both ecosystems and human societies require energy flows, energy transformations and energy storages. However, different categories of energy vary in source and quality and they have fundamental differences in availability and value. The EROI method helps to connect conceptually the production capacity of both ecosystems and economic systems. If the EROI value reaches 1:1, it means this production activity is no longer energetically favorable—whether in an ecosystem or economic system. Although the EROI value of some energy extraction processes can reach 1:1, the production activity can only continue if subsidized by some other fuel. This appears the case for corn-based ethanol in the US.

The declining trend of the EROI of the Daqing oil field demonstrates that oil and gas extraction is becoming more and more difficult even for very large and relatively well-managed fields such as Daqing. The reason is principally that as fields age they require energy-intensive techniques, such as water and polymer injection under substantial pressure. The productivity of any oil field eventually declines regardless of other circumstances. The reasons for the decline are varied, but the important thing is that it seems that depletion of this oil field is a more powerful factor than technological improvements. Also, the reason for the decline in EROI is that while the production of Daqing decreased slowly, the investment of funds and energy increased almost linearly. This paper makes a simple prediction by extrapolating the output and input of Daqing oil field and concludes that the EROI is likely to continue declining over the next 5 years. We utilize the increasing rate of output and input as heat equivalent to make a linear extrapolation, to project the $EROI_{\text{std}}$ for the next 5 years (Figure 10). If the decline in EROI continues to follow the present rate, it will reach very low values within one to two decades. In contrast, the output of the Daqing oil field is supposed to be determined by the national plan, which calls for the continued production of 295.6 million barrels. We accept this for the moment, and, make another extrapolation, using this assumption but also assuming that input increased from 2001 to 2009. Then, the EROI declines even if oil production remains flat. Since production of this oil field has been under the control of government which takes great pride in its ability to manage it, the decline in production is rather an embarrassment. The decline in EROI only makes matters worse, but is consistent with what is happening with nearly all other fossil fuels, as seen in this special volume.

Figure 10. History and forecast of $EROI_{\text{std}}$. Black line is history $EROI_{\text{std}}$; Red line is extrapolated based on best linear fit to trend; blue line is an extrapolation of costs, as assuming government goals for production are met, but costs continue to increase.

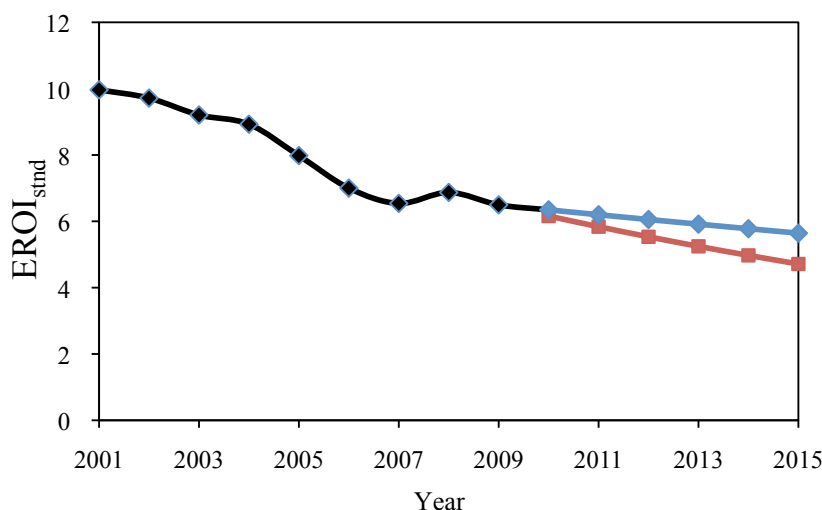

Net energy analysis related to EROI is of great importance, reflecting the amount of energy which can actually be delivered to society. We find that the net energy of Daqing oil field has the same trend as EROI, both of which are declining, at 3.7% per year (Figure 11). From the point of view of energy value, production will lose its significance if the net energy reaches zero, which would impact China's

oil industry deeply. Hence, both continuously decreasing EROI and net energy output indicate that the Daqing oil field is suffering from serious challenges now and in the future.

Over the past five years, China's energy consumption increased 6.8% annually, which contributed to the development of the national economy, which has been growing at 11.4% each year. China's economy demands long-term reliable oil production into the future. According to forecasts [28], China's oil production will probably reach a peak in 2011, at 1450 million barrels. Thereafter, the development of China's economy may be severely constrained by the limitation of energy. As the largest oil field in China at present, the strategic objective of Daqing is sustainable and effective development to create an "evergreen enterprise" to continue to contribute to China's economic, political and social development by supplying plenty of oil. Nevertheless, the Daqing oil field is becoming of lower importance in the national oil supply as its share of total production dropped from 51.3% to 21.1% in 2009. The managers of the Daqing oil field should become fully aware of the warning index that EROI and net energy play, and then adjust to this reality.

Figure 11. Net energy and decrease rate.

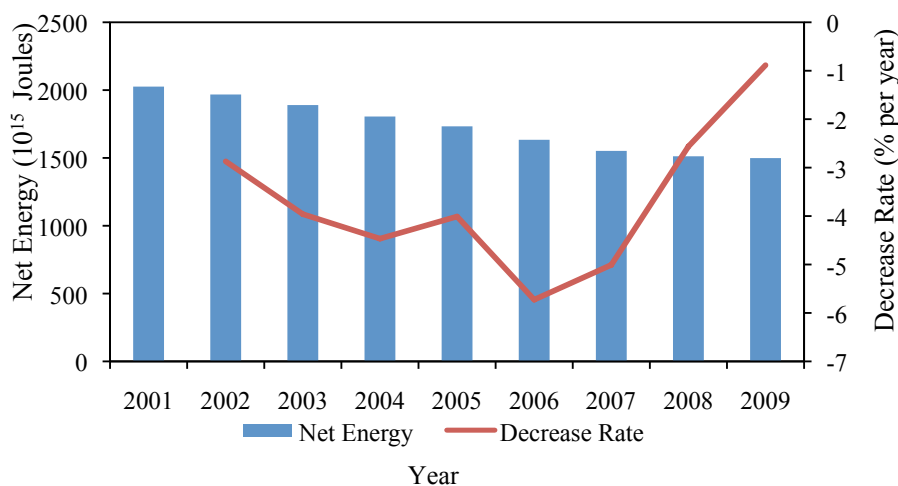

Acknowledgements

This research has been supported by National Natural Science Foundation of China (No. 71073173). We are grateful to two friends at SUNY-ESF, David Murphy and Xiaoliang Yang and three anonymous reviewers who helped improve the manuscript substantially.

References and Notes

1. Cottrell, W.F. *Energy and Society: The Relationship Between Energy, Social Change, and Economic Development*; McGraw-Hill, Book Company: New York, NY, USA. **1955**.
2. Odum, H.T. *Environment, Power and Society*; Wiley-Interscience: New York, NY, USA. 1971; p. 336.
3. Hall, C.A.S.; Cleveland, C.; Berger, M. Yield per effort as a function of time and effort for United States petroleum, uranium, and coal. In *Energy and Ecological Modelling*; Mitsch, W.J., Bosserman, R.W., Klopatek, J.M., Eds.; Elsevier Scientific: Amsterdam, The Netherlands, 1981, 715-724.

Sustainability **2011**, *3*

4. Cleveland, C.J.; Costanza, R.; Hall, C.A.S.; Kaufmann, R. Energy and the U.S. economy: A biophysical perspective. *Science*. **1984**, *255*, 890-897.
5. Murphy, D.J.; Hall, C.A.; Dale, M.; Cleveland, C. Order from chaos: A preliminary protocol for determining the EROI of fuels. *Sustainability* **2011**, *3*, 1888-1907.
6. Cleveland, C.J. Net energy from the extraction of oil and gas in the United States. *Energy* **2004**, *30*, 769-782.
7. Gagnon, N.; Hall, C.A.S.; Brinker, L. A preliminary investigation of energy return on energy investment for global oil and gas production. *Energies*. **2009**, *2*, 490-503.
8. Lin, Z., Lianyong, F., Hall, C.A.S. Is Peakoilism Coming? *Energ. Policy* **2009**, *37*, 2136-2138.
9. U.S. Energy Information Administration, 2011. <http://www.eia.gov/countries/cab.cfm?fips=CH> (accessed on 25 November 2011).
10. Adams, F.G., Miovic, P. On relative fuel efficiency and the output elasticity of energy consumption in Western Europe. *J. Ind. Econ.* **1968**, *17*, 41-56.
11. Cleveland, C.J. Energy quality and energy surplus in the extraction of fossil fuels in the U.S. *Ecol. Econ.* **1992**, *6*, 139-162.
12. Energy statistics department of national bureau of statistics of China. *China Energy Statistical Yearbook 2009*. China Statistics Press: Beijing, China, 2009, 3-15.
13. Berndt, E.R. Aggregate energy, efficiency and productivity measurement. *Annu. Rev. Energy.* **1978**, *3*, 225-273.
14. Berndt, E.R. Energy use, technical progress and productivity growth: A survey of economic issues. *J. Prod. Anal.* **1990**, *2*, 67-83
15. Brown, M.T.; Ulgiati, S. Energy quality, emergy, and transformity: H.T. Odum's contributions to quantifying and understanding systems. *Ecol. Model.* **2004**, *178*, 201-213.
16. Odum, H.T.; Peterson, N. Simulation and evaluation with energy systems blocks. *Ecol. Model.* **1996**, *93*, 155-173.
17. Trends in Oil Prices. *International Petroleum Economic* **2002**, *10*, 58.
18. Trends on oil Prices. *International Petroleum Economic* **2003**, *11*, 57.
19. Trends on oil Prices. *International Petroleum Economic* **2004**, *12*, 66.
20. Trends on oil Prices. *International Petroleum Economic* **2005**, *13*, 65.
21. Trends on oil Prices. *International Petroleum Economic* **2006**, *14*, 69.
22. Oil Price Trends. *International Petroleum Economic* **2007**, *7*, 73.
23. Oil Price and Related Index Trends. *International Petroleum Economic* **2008**, *4*, 92.
24. Oil Price and Related Index Trends. *International Petroleum Economic* **2009**, *7*, 87.
25. Trend of Oil Price and Relevant Indexes. *International Petroleum Economic* **2010**, *2*, 85.
26. Trends in Oil Prices and Relevant Indices. *International Petroleum Economic* **2011**, *6*, 107.
27. National Development and Reform Commission. <http://www.sdpc.gov.cn/zfdj/default.htm> (accessed on 25 November 2011)
28. Lianyong, F.; Junchen, L.; Xiongqi, P. China's oil reserve forecast and analysis based on peak oil models. *Energ. Policy* **2008**, *36*, 4149-4153.

© 2011 by the authors; licensee MDPI, Basel, Switzerland. This article is an open access article distributed under the terms and conditions of the Creative Commons Attribution license (<http://creativecommons.org/licenses/by/3.0/>).

Article

The EROI of Conventional Canadian Natural Gas Production

Jon Freise

Principal Engineer, 3501 Cedar Ave So, Minneapolis, MN 55407, USA;

E-Mail: jon.e.freise@gmail.com; Tel.: +1-612-377-0753; Fax: +1-612-377-0753

Received: 23 June 2011; in revised version: 1 August 2011 / Accepted: 5 August 2011 /

Published: 3 November 2011

Abstract: Canada was the world's third largest natural gas producer in 2008, with 98% of its gas being produced by conventional, tight gas, and coal bed methane wells in Western Canada. Natural gas production in Western Canada peaked in 2001 and remained nearly flat until 2006 despite more than quadrupling the drilling rate. Canada seems to be one of many counter examples to the idea that oil and gas production can rise with sufficient investment. This study calculated the Energy Return on Energy Invested and Net Energy of conventional natural gas and oil production in Western Canada by a variety of methods to explore the energy dynamics of the peaking process. All these methods show a downward trend in EROI during the last decade. Natural gas EROI fell from 38:1 in 1993 to 15:1 at the peak of drilling in 2005. The drilling intensity for natural gas was so high that net energy delivered to society peaked in 2000–2002, while production did not peak until 2006. The industry consumed all the extra energy it delivered to maintain the high drilling effort. The inability of a region to increase net energy may be the best definition of peak production. This increase in energy consumption reduces the total energy provided to society and acts as a contracting pressure on the overall economy as the industry consumes greater quantities of labor, steel, concrete and fuel. It appears that energy production from conventional oil and gas in Western Canada has peaked and entered permanent decline.

Keywords: EROI; energy return on investment; net energy; Western Canada

1. Introduction

At the start of the 21st century we have a lot of pressing questions about our future energy supply: Can the world maintain its oil production plateau? Can natural gas production grow to replace coal and

oil? Is it physically possible to grow the economy using renewable energy sources or even transition to renewable energy sources?

What ties these questions together is a concept called net energy. It takes an investment of energy (in the form of fuel, steel, labor, and more) to produce energy. The net energy is the amount of surplus after this investment has been paid. This surplus is the energy available to operate the rest of the economy. All of these questions may be asked in a simpler form: Can we do X and still maintain or grow the net energy supply? Thus, insight gained from understanding the energy production of fossil fuels may transition to understanding of the growth (or decline) of renewable energy sources.

Canada's oil and natural gas industry makes an interesting case study for net energy analysis. The country is a very large petroleum producer and was the world's third largest natural gas producer in 2008 [1] and most of that production comes from the onshore Western Canadian Sedimentary Basin (WCSB). It went through a peak in oil production in the 1970s and, despite an increase in drilling, the country could not return to peak rates. Most recently, natural gas production fell from an eight-year plateau despite a 300% increase in the rate of drilling and an even greater increase in investment.

A net energy analysis of Canadian conventional oil and natural gas provides several things: Firstly, it is a measurement of current conditions. How much net energy is being produced now and what is the trend? Secondly, it provides insight into the net energy dynamics of the production growth, peak/plateau, and decline for oil and natural gas production. Thirdly, it gives some indication of what net energy levels are needed for an energy system to grow and below which levels cause a peak or decline in the energy system.

This paper will calculate the net energy for oil and, most importantly, natural gas production in the WCSB using publically available data on a fine grained yearly basis. Three methods will be used: The simplest will calculate a net energy return for oil and natural gas back to 1947 for historical reference and to encompass the 1973 oil peak. Two others will calculate the yearly net energy of natural gas production from 1993 onward: the first using publically available statistical data and the second using natural gas cost per GJ estimates created periodically by the Canadian National Energy Board (NEB) for forecasting purposes. The results will then be examined to see what conclusions can be drawn about the current state of oil and gas net energy, the energy dynamics of the production peaks, and what these results might mean for non-Canadian natural gas production and growth of energy sources in general.

1.1. Net Energy and the Economy

It takes energy to produce energy. For natural gas and oil production, energy is consumed as fuel to drive drilling rigs and other vehicles, energy to make the steel in drill and casing pipe, energy to heat the homes of the workers and provide them with food. These energy expenditures make up the cost of producing energy. Net energy is the surplus energy after these costs have been paid. The equation for net energy is shown in Equation 1.

$$\text{Net Energy} = \text{Energy Outputs} - \text{Energy Inputs} \quad (1)$$

This is often expressed as a ratio called Energy Return on energy Invested:

$$EROI = \frac{\text{Energy Outputs}}{\text{Energy Inputs}} \quad (2)$$

The net energy is the energy available for powering the economy. Energy supply and demand are intrinsically linked by more than the price, because the supply is creating (powering) the demand. This point is crucial for understanding the net energy dynamics of a peak in oil and gas production.

High energy prices cause recessions [2-5] and Figure 1, a simple schematic of net energy adapted from [6], helps illustrate the reason for this from a net energy perspective. The red represents the energy needed to produce energy. The dark green is the energy consumed refining, transporting and using the energy. The light green is the energy surplus available to operate, maintain and possibly grow the economy. Column A represents the economy before the cost of energy rises, and column B is the economy afterwards.

Figure 1. (a) Energy return on energy invested (EROI) 20:1 energy supply & surplus; (b) contraction caused by fall to 10:1 EROI; and (c) Surplus returned by higher end use efficiency.

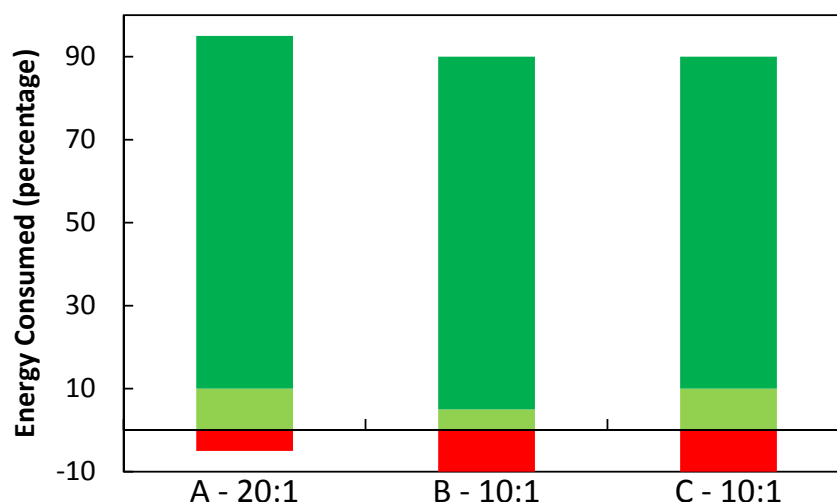

As costs rise, the energy sector makes a huge increase in its demand for labor, steel, fuel, *etc.* from society at large, shown by a large increase in the red area. But at the same time, the energy sector is providing no additional energy that is needed to create that extra steel, supply the fuel, or support the labor. Society must then cannibalize other sectors to supply the demands of the energy sector and the non-energy economy is seen to contract. This non-energy sector contraction would then cause a collapse in demand for energy, and returning society to somewhere between A and B.

To help formalize this example, assume Figure 1 shows a theoretical energy source supplying 1 Giga Joule (GJ) of energy. The three columns show three different net energy conditions. Column A shows an energy supply that requires 5% of the gross energy as input energy. It has an EROI of 20:1 and a net energy of 95%.

Column B shows the same energy source, but where the cost of producing energy has doubled to consume 10% of the gross energy supply. It has an EROI of 10:1 and a net energy of 90%. The transport, refining, and end use efficiency remain the same and so the final surplus has contracted.

Column C represents a society that has adapted to the lower EROI energy source by improving efficiency of use and the surplus has returned. The more efficient a society, the lower the net energy supply it may subsist upon. This last point will be important when examining the difference between the peaks in oil and natural gas.

1.2. Background on the Western Canadian Sedimentary Basin

Western Canada produced 98% of Canada's natural gas in 2009 with the majority of that coming from the Western Canadian Sedimentary Basin (WCSB) that underlies most of Alberta, parts of British Columbia, Saskatchewan and the Northwest Territories [7].

Figure 2. Natural gas producing areas in Canada, highlighting the Western Canadian Sedimentary Basin (WCSB). Reproduced from [8].

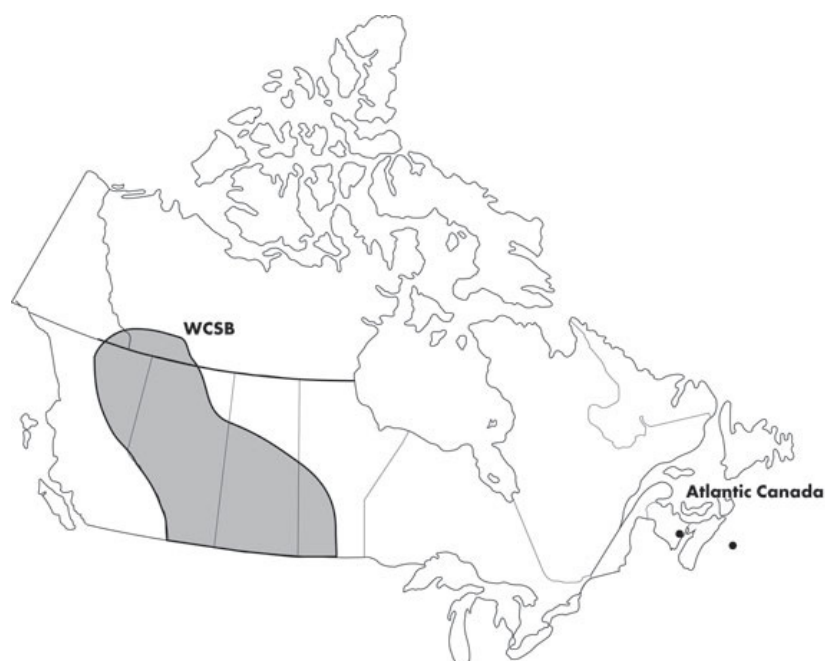

This paper focuses on conventional natural gas, tight natural gas (gas in a low porosity geologic formation that must be liberated via artificial fracturing) and conventional oil production. Western Canadian natural gas production is still largely conventional and so makes a good area of study. In 2008, 55% of marketed natural gas was conventional gas from gas wells, 32% was tight gas, 8% was solution gas from oil wells, 5% coal bed methane (non-conventional), and less than 1% was shale gas [9,10].

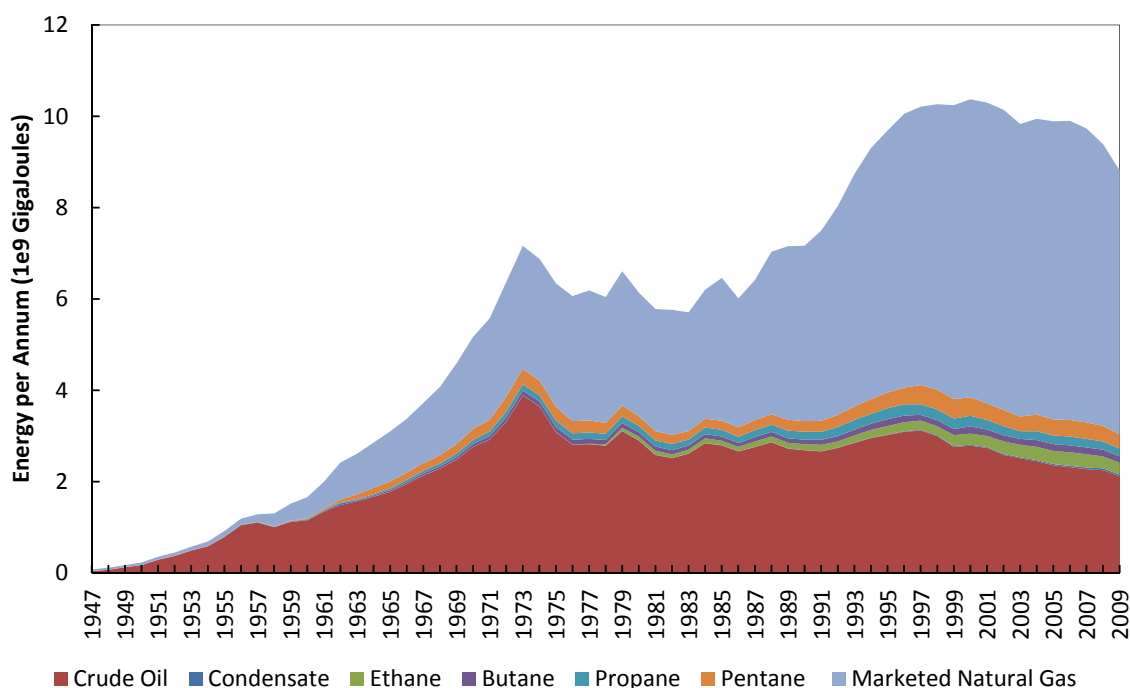
Figure 3. Energy Content of Petroleum Production, by type, stacked.

The Canadian Gas Potential Committee in 2005 estimated that the WCSB contains 71% of the conventional gas endowment of Canada and that of an original 278 Tcf of marketable natural gas (technically and economically recoverable) 143 Tcf remain [11]. They note: “The majority of the large gas pools have been discovered and a significant portion of the discovered reserves has been produced” and further “62% of the undiscovered potential occurs in 21,100 pools larger than 1 Bcf OGIP. The remaining 38% of the undiscovered potential occurs in approximately 470,000 pools each containing less than 1 Bcf”. To put this in context, the petroleum industry has drilled less than 200,000 natural gas wells from 1947 to 2009 [7], and so will require at least a doubling of drilling effort to reach at least half of the marketable natural gas.

2. Results and Discussion

2.1. Method One: EROI and Net Energy of Western Canadian Oil and Gas Production

The Canadian Association of Petroleum Producers (CAPP) maintains records of oil and gas production and expenditures going back to 1947. In theory it is simple to calculate net energy and EROI from this public data. Energy output equals the total production volumes of each hydrocarbon produced in a given year (conventional oil, natural gas, natural gas liquids), which is converted to heat energy equivalents, and measured in Giga Joules. The energy input side is more difficult as the public data for expenditures is recorded only in Canadian \$ per year and not in energy. An energy intensity factor is used to convert the dollar expenditures into energy. This factor is calculated from Energy Input Output—Life Cycle Analysis as explained in Section 3 methods. Equation 3 shows the final form:

$$Net\ Energy(J) = Heat\ Energy\ Output(J) - (\$ * Energy\ Intensity(\frac{J}{\$})) \quad (3)$$

As the energy intensity factor includes wages paid to labor, but energy inputs are not quality corrected, the results are equivalent to $EROI_{society}$ and not the $EROI_{Standard}$ [12]. $EROI_{Standard}$ corrects the input energy for quality but excludes labor costs. The energy intensity factor was 24 MJ/\$(U.S. 2002) and all expenditures were inflation corrected and converted to U.S. dollars. While the focus of this paper is on natural gas production, this result provides a historical time line to compare with the more limited time series for natural gas only. The results are first plotted as gross energy and net energy alongside the meters drilled per year as in Figure 4.

Figure 4. Net Energy content of oil and gas produced after invested energy is subtracted, with total meters drilled.

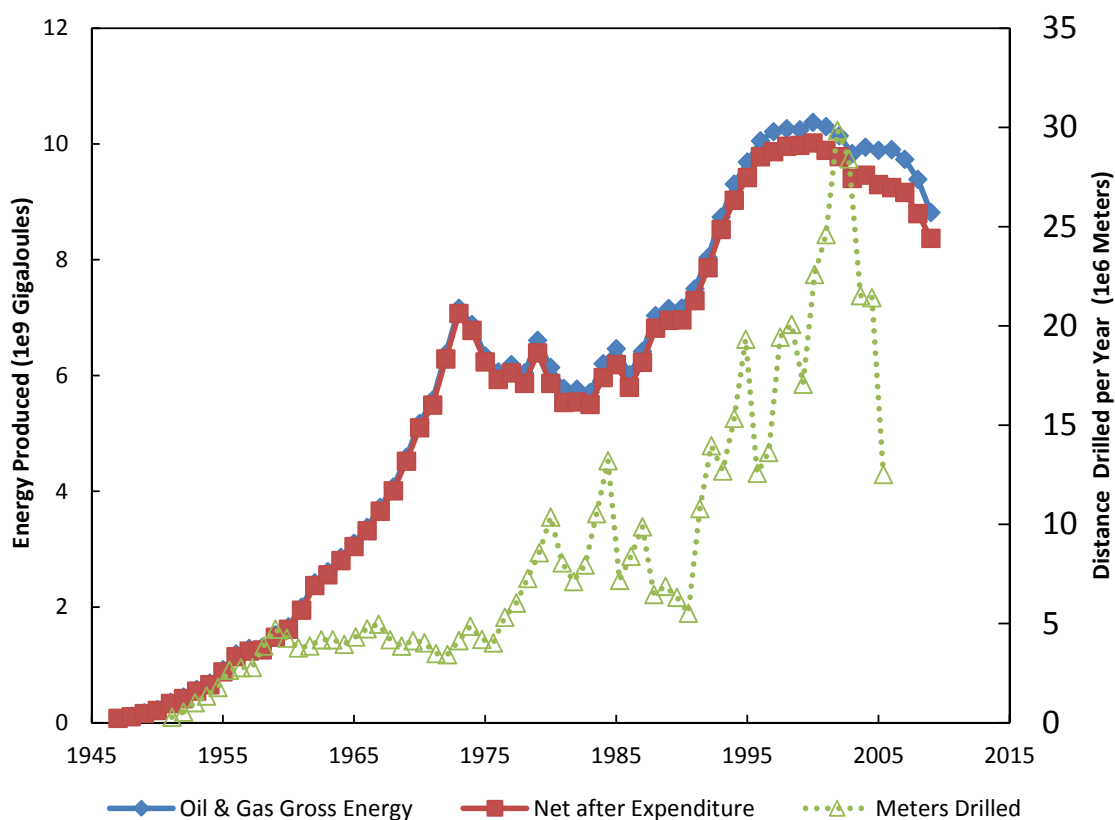

The time period from 1947 to 1956 showed rising production along with a rising drilling rate. From 1956 to 1973 production rose despite no corresponding rise in drilling. From 1973 to 1985 production fell despite a rise in drilling effort. The increased drilling rates were unable to increase gross energy and actually drove down net energy during this period.

In the mid-1980s, energy production once again rose with a falling drilling rate. That trend reversed to rising production with increased drilling. Then, in the year 2000, the petroleum industry showed an initial peak in gross and net energy (see Table 1). The increases in drilling effort that happened after 2000 were unable to increase production and actually drove down net energy (falling EROI). When the

drilling rate increased, it drove down net energy. When the drilling rate slowed (as it did after 2006) then production dropped and net energy fell even faster.

Table 1. Annual gross and net energy production of oil, gas, and natural gas liquids.

Year	Gross Energy Production (1 e ⁹ GJ)	Net Energy Production (1 e ⁹ GJ)	Industry Expenditures (1 e ⁹ U.S.\$ 2002)	Energy Invested via 24 MJ/\$ (1 e ⁶ GJ)	EROI	Oil & Gas Meters Drilled (1 e ⁶)
1993	8.74	8.53	\$8.8	212	41	10.80
1994	9.31	9.03	\$11.7	280	33	13.97
1995	9.69	9.42	\$11.2	269	36	12.69
1996	10.06	9.78	\$11.5	275	37	15.35
1997	10.22	9.87	\$14.5	347	29	19.33
1998	10.26	9.96	\$12.7	304	34	12.58
1999	10.25	9.98	\$11.2	269	38	13.63
2000	10.38	10.02	\$14.8	356	29	19.44
2001	10.30	9.89	\$17.0	409	25	20.08
2002	10.14	9.78	\$15.0	361	28	17.07
2003	9.83	9.41	\$17.8	428	23	22.60
2004	9.95	9.46	\$20.1	483	21	24.61
2005	9.89	9.30	\$24.7	592	17	29.86
2006	9.90	9.25	\$27.3	656	15	28.42
2007	9.74	9.17	\$23.8	571	17	21.53
2008	9.39	8.80	\$24.7	592	16	21.43
2009	8.82	8.37	\$18.6	446	20	12.52

Plotting the same data as EROI is quite illuminating. Figure 5 shows that the industry underwent a dramatic rise in energy efficiency from the early 1950s until 1973 when it reached a peak in EROI of 79:1. At this peak the industry consumed only the equivalent of 1% of the energy it produced. Then, the industry suffered a tremendous efficiency drop to a low EROI of 22:1 (about 5% of energy production consumed by investment) only 7 years later as the industry more than doubled its drilling rate in an effort to return to the oil production peak.

Another interesting inflection point was 1985 when the industry started a 7-year period when a reduced drilling rate providing an increase in production. We can see this corresponded to an increase in efficiency as the industry focused on growing natural gas production (see Figure 3). EROI rose to 46:1 (about 2% consumed by investment) by 1992. This fortunate trend was not long lived. Once the drilling rate started to rise, EROI has had a volatile but downward trend to a new low of 15:1 in 2006, where the industry consumed the equivalent of 7% of all the energy it produced. And further, it took a dramatic reduction in drilling and falling back on the production of older wells to achieve the small uptick in EROI seen in 2009.

Figure 5. EROI of oil and gas from 1947 to 2009 with meters drilled.

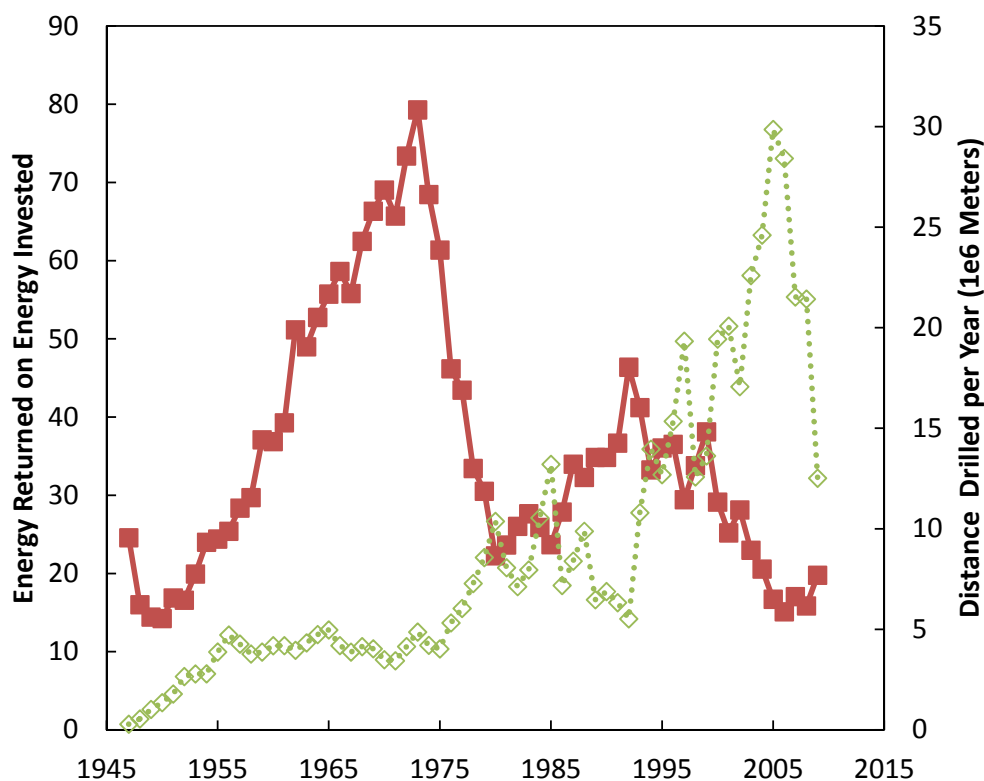

2.2. Method Two: Net Energy and EROI of Western Canadian Natural Gas Wells

Natural gas from conventional and tight natural gas wells is now the dominant energy source in the WCSB and has just recently peaked. By removing the oil from the net energy and EROI calculations we can gain an insight into the energy dynamics of peak natural gas production. The data necessary to separate oil and gas production and expenditure is limited to 1993 to 2009. The details of splitting out both gas expenditures and gas production from the oil data are explained in Section 3 methodology. The basic method for finding the net energy from natural gas wells alone is very similar to that for oil and natural gas combined. On the energy output side, the difficulty is that oil wells also produce natural gas and NGL and the amount from oil vs. gas wells is not recorded in the CAPP statistics. A NEB report [13] did report the amount of oil well-associated gas for a limited time series and this relation was used to estimate the amount of associated gas for the remaining years. On the input side, the expenditures for oil and gas well drilling and production are also intermixed. As drilling is the largest expense, it was assumed that the distance of drilling is directly proportional to percentage of expenditures. For example, if gas wells were 75% of the meters drilled, then 75% of exploration and development costs were apportioned to natural gas production.

Figure 6 shows the resulting EROI for natural gas wells and displays a variable but downward trend in EROI over the whole data period except for a rebound during 2007 to 2009 when drilling rates fell back to 1998 levels. However, the EROI did not return to 1998 levels along with the drilling rate.

Figure 6. EROI of natural gas wells with meters drilled.

Table 2 displays the net energy of natural gas well production. The peak for the estimated gross energy from natural gas wells occurred in 2006 at $6.9 \text{ e}^9 \text{ GJ}$, but the peak in net energy happened much sooner. In 2002, net energy peaked at 6.5 GJ . The drilling industry doubled the meters drilled from 2002 to 2005, but could not deliver more net energy to society. The additional industry investment consumed all the extra energy produced, and more.

Table 2. Gross and net energy from natural gas wells.

Year	Gross Energy ($1 \text{ e}^9 \text{ GJ}$)	Net Energy ($1 \text{ e}^9 \text{ GJ}$)	Industry Gas Directed Expenditure ($1 \text{ e}^9 \text{ U.S. 2002}$)	Energy Invested via 24MJ/\$ (U.S. 2002) ($1 \text{ e}^6 \text{ GJ}$)	EROI	Gas Intent Meters Drilled (1 e^6)
1993	5.03	4.90	5.53	133	38	3.06
1994	5.46	5.27	7.85	188	29	5.34
1995	5.74	5.58	6.85	164	35	3.54
1996	6.02	5.85	6.76	162	37	3.86
1997	6.13	5.94	7.85	188	33	5.32
1998	6.35	6.14	8.93	214	30	5.32
1999	6.66	6.45	8.59	206	32	7.06
2000	6.76	6.51	10.70	257	26	9.11
2001	6.75	6.44	12.77	307	22	10.47

Table 2. Cont.

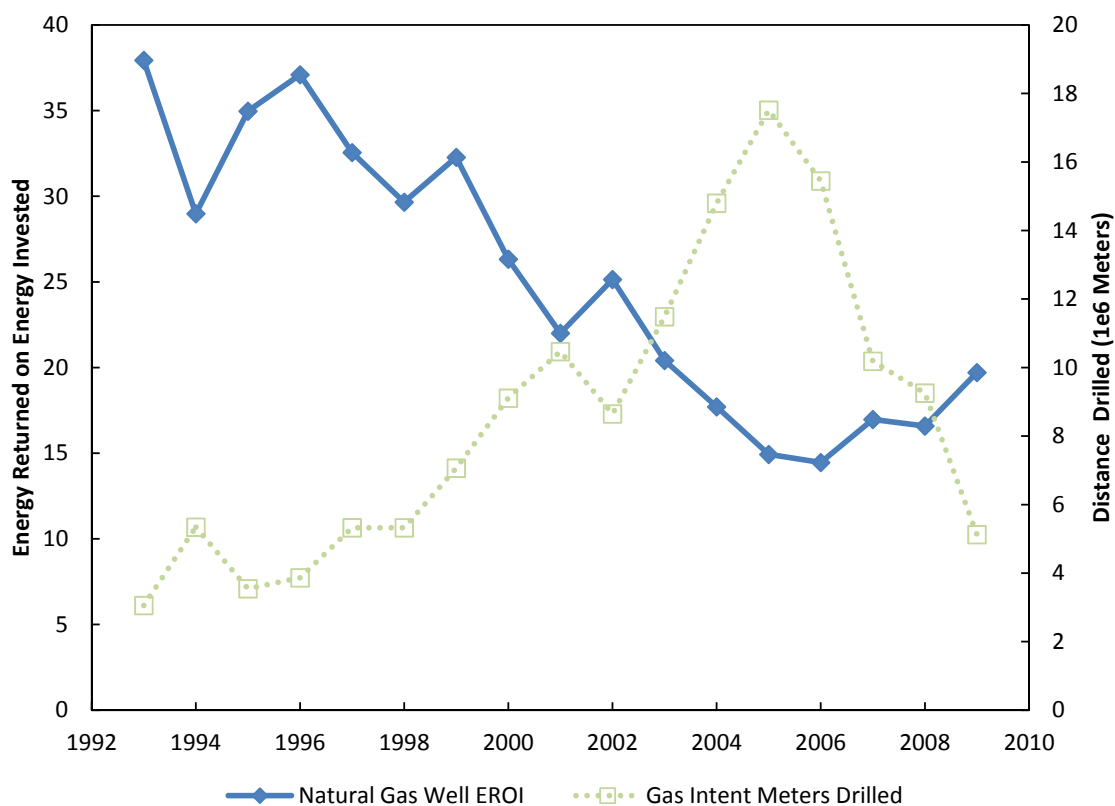
Year	Gross Energy (1 e ⁹ GJ)	Net Energy (1 e ⁹ GJ)	Industry Gas Directed Expenditure (1 e ⁹ \$U.S. 2002)	Energy Invested via 24MJ/\$(U.S. 2002) (1 e ⁶ GJ)	EROI	Gas Intent Meters Drilled (1 e ⁶)
2002	6.79	6.52	11.25	270	25	8.65
2003	6.62	6.30	13.51	324	20	11.49
2004	6.79	6.40	15.97	383	18	14.80
2005	6.83	6.37	19.06	458	15	17.51
2006	6.90	6.43	19.90	478	14	15.45
2007	6.82	6.42	16.75	402	17	10.19
2008	6.53	6.14	16.41	394	17	9.26
2009	6.11	5.80	12.92	310	20	5.12

2.3. Method Three: EROI of Western Canadian Natural Gas Using Estimated Ultimate Recovery

The first two methods used to estimate EROI suffer an inherent inaccuracy: The output energy of a given year is mostly produced by wells drilled in past years. Figure 7 shows an example of how production from wells drilled each year stack on top of each other to yield the annual production rate. Each colored band represents the natural gas produced from a given year's wells. The wells drilled from 2003 to 2004 produced the yellow band. It is easy to see from this chart how most of the natural gas produced in 2003 was actually from wells drilled in prior years.

Figure 7. Canadian National Energy Board (NEB) Estimate of natural gas produced by wells drilled each year. From [8].

WCSB Total Historical Gas Production by Connection Year

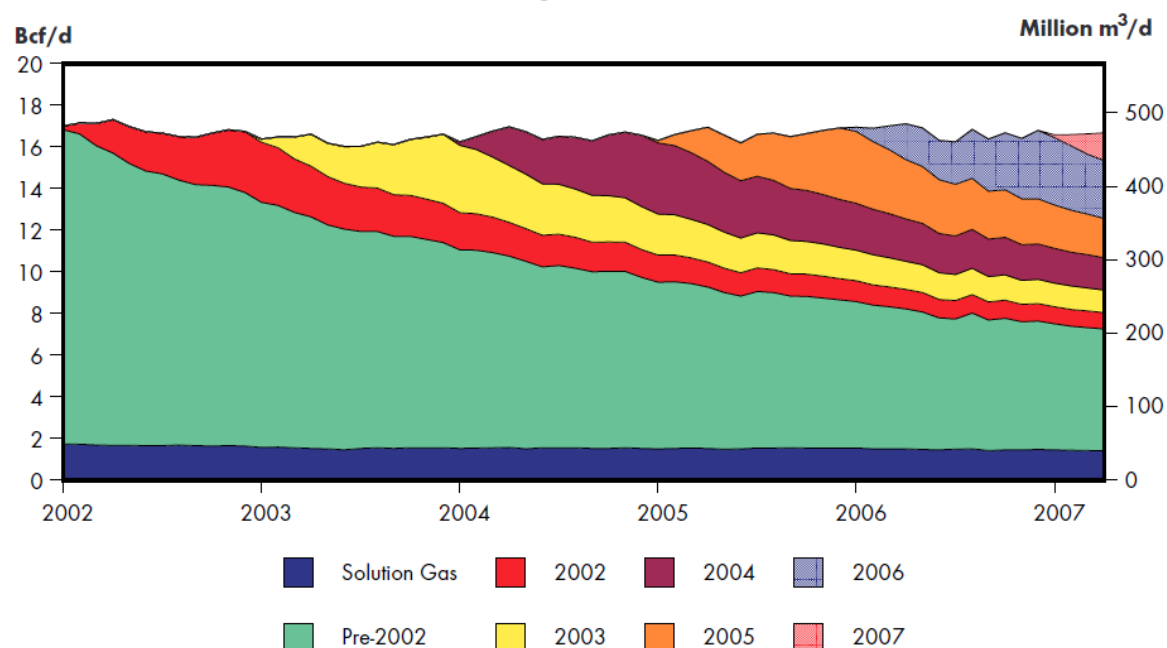

Source: NEB Analysis of GeoScout Well Data

A well may produce oil or gas for 30 years, but all the expense is applied during the year it was drilled. This mismatch in time scales can cause EROI to spike and dip if the drilling rate moves up and down. A rapid increase in drilling can cause EROI to dip as the investment is booked all at once, but production will take years to arrive. A rapid decrease in drilling will cause investment to suddenly drop, while production from wells from previous years stays high and will result in an EROI spike. These spikes and dips are exactly how the economy experiences the change in energy flows, and so it is perfectly valid to use this technique, but the averaging effect hides how the newest wells are performing.

One method to reveal current well performance would be to attribute the expected full life production of the well, the Estimated Ultimate Recovery (EUR), against the investment amount the year the well was drilled. The Canadian National Energy Board does periodic studies of producing natural gas. They calculate the EUR for the wells drilled each year [8]. They examined the wells drilled each year, totaled the past production from those wells, and used decline curves to estimate the remaining production of each year's wells.

In this third method, the NEB calculated EUR was used instead of the annual production statistics for that year. The goal was to try to estimate the EROI of the very latest natural gas wells drilled and thus learn if the natural gas EROI rebound seen with the rolling average method was an artifact of the drop in drilling rate or if the natural gas wells improved in quality. The results are shown in Tables 3 and 4 and Figure 8. Again, the EROI trend is clearly declining. A specific example is to compare 1997 to 2005. Both years have very similar estimated ultimate recovery (EUR), but 2005 had a capital expenditure that was 3 times higher. This strongly suggests that the well prospects worsened over a short time period.

Table 3. Estimated Ultimate Recovery (EUR) and cost per GJ for natural gas wells.

Year	Estimated Ultimate Recovery (1 e ⁹ GJ)	Exploration & Development Cost \$ (U.S. 2002)	Exploration & Development \$(U.S. 2002) per GJ	Oil & Gas Energy Production (1 e ⁹ GJ)	Oil & Gas Operating Cost (1 e ⁹ \$ U.S. 2002)	Operating Cost \$(U.S. 2002) per GJ
1996	4.92	\$3.34	\$0.68	9.95	\$6.23	\$0.45
1997	5.90	\$4.88	\$0.83	10.11	\$6.27	\$0.44
1998	5.93	\$5.33	\$0.90	10.16	\$6.17	\$0.42
1999	5.61	\$4.71	\$0.84	10.14	\$6.49	\$0.44
2000	6.05	\$6.59	\$1.09	10.26	\$7.43	\$0.48
2001	6.46	\$8.36	\$1.29	10.17	\$8.24	\$0.53
2002	5.63	\$6.68	\$1.19	10.02	\$8.75	\$0.56
2003	6.17	\$8.38	\$1.36	9.72	\$9.29	\$0.59
2004	6.77	\$10.55	\$1.56	9.77	\$9.80	\$0.61
2005	5.98	\$12.99	\$2.17	9.74	\$11.20	\$0.68
2006	6.43	\$14.26	\$2.22	9.74	\$12.56	\$0.75
2007	4.76	\$10.52	\$2.21	9.60	\$13.50	\$0.80
2008	4.44	\$10.51	\$2.37	9.26	\$14.41	\$0.87

Table 4. Total cost per GJ, Net EUR and EROI for natural gas wells.

Year	Total Cost \$(U.S. 2002) per GJ	Invested Energy per GJ via 24 MJ/\$(U.S. 2002) in MJ	Net Estimated Ultimate Recovery (1 e ⁹ GJ)	EROI
1996	\$1.13	27	4.79	37
1997	\$1.26	30	5.72	33
1998	\$1.32	32	5.74	31
1999	\$1.28	31	5.44	33
2000	\$1.57	38	5.83	27
2001	\$1.82	44	6.18	23
2002	\$1.74	42	5.39	24
2003	\$1.95	47	5.88	21
2004	\$2.17	52	6.42	19
2005	\$2.86	69	5.57	15
2006	\$2.97	71	5.97	14
2007	\$3.01	72	4.41	14
2008	\$3.24	78	4.09	13

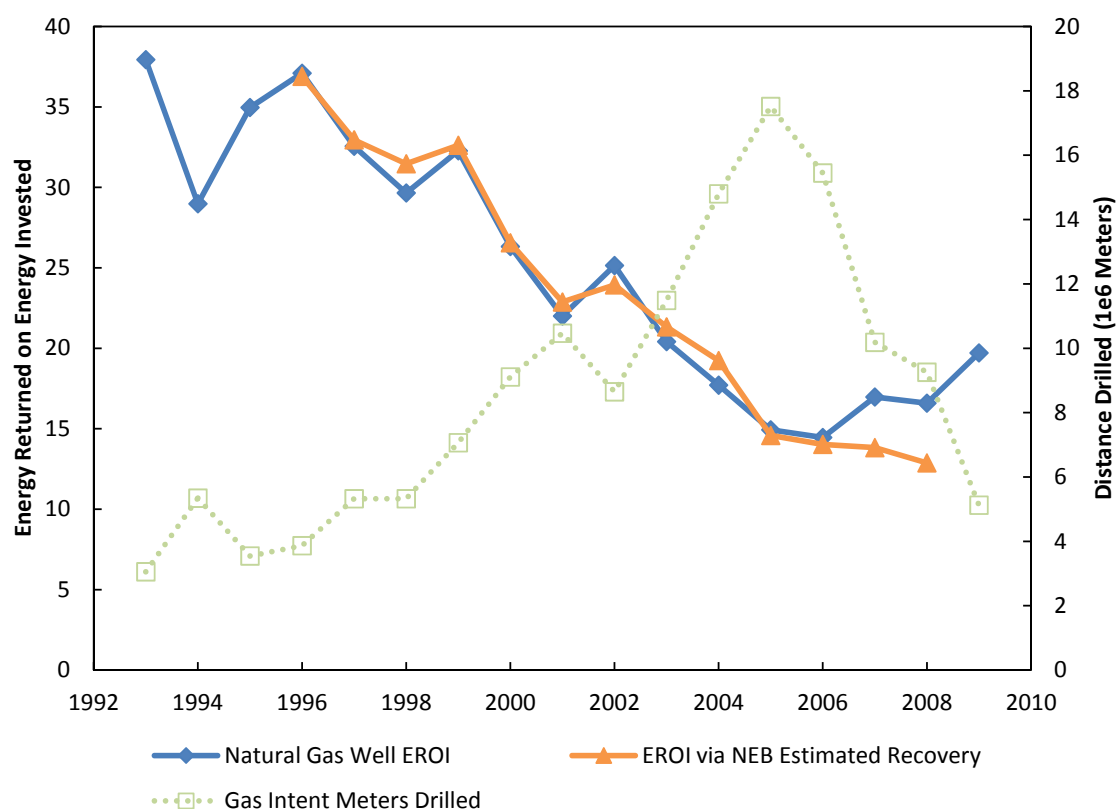
Figure 8. EROI using NEB estimates of ultimate recovery, with meters drilled.

The EROI curve in Figure 8 is slightly less volatile than the rolling average technique, but more strikingly, the years 2007 and 2008 do not show the rebound in EROI that the rolling average method displayed. Assuming the NEB estimates for EUR are correct, this result indicates that the rebound was

an artifact of the rapidly falling drilling rate on the rolling average and that new wells are performing considerably worse than prior years' wells.

3. Methods

This section describes how the three sets of net energy and EROI results were calculated. The basic method is explained here and the specifics of each method are in the following subsections. Net energy and EROI are both calculated from energy inputs and outputs (see equations 1 and 2), and are both very simple to calculate in theory.

The energy outputs are calculated using annual oil and natural gas production statistics (or for method 3 an estimate of each year's production, as explained below). All production volumes are converted into heat energy equivalents using conversion factors provided by the Canadian National Resource Board [9] and shown in Table 5.

Table 5. Volume to energy conversion factors from the NEB.

Dry Natural Gas	37.9 GJ per 1 e ³ m ³ gas
Ethane	18.36 GJ per m ³ liquid
Propane	25.53 GJ per m ³ liquid
Butanes	28.62 GJ per m ³ liquid
Condensate and Pentanes plus	35.17 GJ per m ³ liquid
Crude Oil	38.51 GJ per m ³ liquid

Energy inputs are much more difficult to calculate. The Canadian petroleum industry does not provide data on how much oil, coal, natural gas and electricity it uses each year (direct energy consumption) nor does it provide data on how many tons of steel, drilling rigs, trucks, *etc.* it uses (indirect energy consumption). However, it does record each year's expenditures in dollars. Several techniques exist for converting the financial expenditures into energy equivalents and are described in detail with examples in [14] as well as [15,16]. The same energy intensity technique to convert expenditures to energy was used in all three methods.

3.1. Energy Intensity

The conversion equation for turning dollar expenditures into energy is:

$$Energy\ Invested(J) = Expenditure\ (\$) \times Energy\ Intensity\ Factor(J/\$) \quad (4)$$

The standard energy intensity is calculated as the energy needed to create each \$ of good or service that an industry provides. The energy intensity is calculated from industry surveys that total the direct energy consumption of an industry (coal, oil, gas, electricity). The energy intensity also factors in the energy in goods or services that an industry purchases from other industries. For example, the automotive industry uses not only the energy that runs its factories directly, but it also uses substantial energy in the form of steel, plastic, and rubber parts it purchases from other industries. There are also circular dependencies, in that, while the steel industry supplies the auto industry, it also uses many trucks and forklifts. These issues are resolved using a technique called energy input-output analysis

that solves large simultaneous equations for the whole economy. The details as to how these calculations are calculated are discussed in [15,17].

The Carnegie Mellon Green Design Institute provides such an analysis for the U.S. Oil and Gas industry for the year 2002 as an Economic Input Output Life Cycle Assessment (EIO-LCA) [18]. They report a value of 14.5 MJ per \$ of oil and gas sold in 2002.

The result must be adjusted because this study requires the energy per \$ expended (not sold) by the industry. Equation 5 shows the conversion:

$$\text{Expended Intensity} = \frac{\text{Energy Intensity per \$ of Goods Sold} \times \text{Total \$ Sold}}{\text{Total \$ Expended}} \quad (5)$$

The total goods sold and total dollars expended for the year 2002 are available from the U.S. Census Bureau reports that formed the basis of the EIO-LCA[19,20]. The oil and gas expenditure values were totaled, including labor costs but excluding royalty payments.

The census treats these as separate industries, but because the two sectors were combined in the EIO-LCA, the census data for expenditures and sales must be combined. The oil and gas costs were removed from the NGL industry expenditures, and the same value of oil and gas sales were removed from the oil and gas extraction industry. The new energy intensity of expenditures was then calculated using these modified figures as follows:

$$24 \text{ MJ per } \$(\text{US2002}) = \frac{14.5 \text{ MJ per } \$ \times \$92.8 \text{ billion total sales}}{\$56.7 \text{ billion total expenses}} \quad (6)$$

This energy intensity result is within the range of 18 to 30 reported by [21] for the U.S. and UK oil and gas industries.

3.2. Assumptions Surrounding the Energy Intensity Value

The Green Design Institute has calculated an energy intensity per \$ of goods sold for the Canadian petroleum industry for the year 2002. However, the value they calculated includes the very energy-intensive tar sands production. Using the CAPP estimates for total goods sold and industry expenditure data for 2002, an energy intensity of 60MJ/\$(U.S.2002) was calculated. This result is well outside the 18 to 30 range for U.S. and UK oil and gas production. It was rejected as not reflecting the conventional oil and gas industry that this study intends to analyze. The U.S. value of 24 MJ/\$(U.S.2002) was selected for use instead. Using the U.S. energy intensity value is not optimal, but with no other data to substitute, this study assumes this value is sufficiently accurate. It is higher than some other values used for upstream alone expenditures because it is for the entire industry, including as well the more energy-intensive (per dollar) direct energy use on site. One important point is that the EIO-LCA was calculated for the year 2002. Results were calculated as far back as 1947, however, the further the result from 2002 the less certain it is.

3.3. EROI Boundary

There are many stages to petroleum production: exploration, drilling, gathering and separation, refining, and transport of finished products, and the burning of the final fuel. The EROI could be calculated at any of these points in the process. Some studies have looked at the EROI of these various

stages [6]. This paper examines the EROI within a boundary that includes the exploration, drilling, gathering and separating stages. This is typically referred to as the upstream petroleum industry and corresponds to NAICS code 21111 Oil and Gas Extraction which includes NAICS 211111 Crude Petroleum and Natural Gas Extraction [19] and NAICS 211112 Natural Gas Liquid Extraction [20]. This analysis does not include refining, the transport of finished products, or the final usage efficiency. This boundary does include labor costs. These results correspond to EROI_{society} (lower case) as described in the EROI protocol [12]. These results are not quite EROI_{Standard} which would include quality correcting the input energy values (not available from the EIO-LCA) and excluding the labor costs (which are rolled into the industry statistics and not removable). Care should be taken to match the boundary conditions before comparing these results to other studies.

3.4. Method One: EROI and Net Energy of Western Canadian Conventional Oil and Gas Production

The Canadian Association of Petroleum Producers (CAPP) maintains statistics on oil and natural gas production and oil and gas expenditures going back to 1947 [22] but the expense data is intermingled. This forces us to estimate the EROI of oil and gas together, but doing so provides a historical perspective for the more limited natural gas EROI that will be calculated later. The net energy and EROI of the combined oil and natural gas industry is thus the first result calculated.

3.5. Energy Output: Oil and Gas Production Statistics

Records of petroleum production are also maintained by CAPP and published in the annual statistical handbook [22]. Summed were the values for Western Canadian conventional oil, marketed natural gas, condensates, ethane, butane, propane, and pentane plus. This paper focuses on conventional production and excludes synthetic oil from tar sands and bitumen production. States included in Western Canada are Alberta, British Columbia, Manitoba, Saskatchewan, and the Northwest Territories. The resulting energy production values are displayed in Figure 3.

3.6. Energy Input: Oil and Gas Expenditure Statistics

CAPP also maintains expenditure statistics for the petroleum industry back to 1947 [22]. Statistics are organized by state and major category. Money paid for land acquisition and royalties were excluded as these do not involve energy expenditure (money paid for land and royalties shifts to who gets to spend the industry profits, not how much energy is expended in extracting the resources). Investment categories include these Exploration expenses: Geological and Geophysical, Drilling and Other. Development expenses include: Drilling, Field Equipment, Enhanced Recovery (EOR), Gas Plants, and Other. Operating expenses include: Well and flow lines, Gas Plants and Other. All expenditures from all categories and states were summed into one value for each year.

3.7. Inflation Adjustment & Exchange Rate

The Canadian dollar expenditure statistics are nominal must be inflation corrected to the year 2002 to use the energy intensity factor calculated via EIO-LCA analysis. The inflation adjustment is

intended to remove the effect of currency devaluation. The inflation adjustment was done using the Canadian CPI [23].

The adjusted results were converted into U.S. \$ using the Bank of Canada Annual Average of Exchange rates for 2002 of \$1.0 (U.S.) to \$1.57 (Canadian) [24] and then converted into Joules of energy input using the expenditures energy intensity factor of 24 MJ/(U.S. 2002).

3.8. Combined Oil and Gas Results and Example

The results are displayed in Table 1 located in Section 2.1. A worked example for the year 2002 has an invested energy of $361 \text{ e}^6 \text{ GJ} = \$15 \text{ e}^9 \times 24 \text{ MJ}/(\$ \text{U.S. } 2002)$. Net energy is $9.78 \text{ e}^9 \text{ GJ} = 10.14 \text{ e}^9 \text{ GJ} - 0.361 \text{ e}^9 \text{ GJ}$ (note the scale change of 361). EROI is $28 = 10.14 \text{ e}^9 \text{ GJ} / 0.361 \text{ e}^9 \text{ GJ}$.

3.9. Method Two: Net Energy and EROI of Western Canadian Natural Gas Wells

The method of calculating the EROI and net energy of natural gas wells is very similar to that used for oil and gas combined. Production and expenditure data were taken from the CAPP statistics and converted to units of energy. Oil production and expenditures were removed (as detailed below). The same energy intensity factor, inflation correction, and exchange rate were used as during the petroleum EROI calculation. The same EROI boundary was used, which includes the gas plants, but not refining or transportation.

3.10. Natural Gas Production Statistics

The energy from oil production was excluded, but natural gas also produced as a byproduct of oil production was included. Natural gas is trapped in solution in the liquid oil. The gas comes out of solution when the pressure drops as the oil is produced. Oil also contains some of the lighter fraction hydrocarbons, such as condensates, propane *etc.* The CAPP statistical handbook does not make the distinction between solution gas and non-associated gas. However, the Canadian National Energy Board provided solution gas data from private sources for the years 2000 to 2008 [13]. Solution gas accounts for about 10% of the total marketed natural gas so it is important it be removed.

For 2000 to 2008 the NEB values were used directly. To extend the solution gas estimates for the whole period of 1993 to 2009, a regression was fit between conventional oil production and the amount of solution gas for the 8 years of data. The linear correlation was high, $R = 0.93$ and the resulting regression was used to predict the amount of solution gas from conventional oil production for the remaining years.

The energy in the lighter hydrocarbons (natural gas liquids) needed to be apportioned between oil and gas wells as they are roughly equal to 16% of the energy in the produced natural gas (so about 1.6% of natural gas well gross energy). No public data could be found that suggested a proper ratio, so for this study it was assumed that the ratio of lighter hydrocarbons associated with oil would be the same as the ratio of natural gas associated with the oil. The solution gas ratio was used for each year and that portion of the total NGLs was removed from the gross energy produced.

3.11. Natural Gas Exploration and Development Expenditures

The CAPP expenditure statistics encompass both oil and gas expenditures, so some secondary statistic is needed to estimate how the combined expenditures should be apportioned. The statistics do separate the meters of exploration and development drilling that target oil vs. gas wells. For this study it was assumed that the apportionment of expenditure dollars would be directly related to the meters of drilling. This assumption is true only if the oil and gas wells have similar costs. As most oil and gas are produced from the same basin, this was assumed to be a reasonable apportionment (as opposed to if all the natural gas were on shore and the oil production was done much more expensively off shore).

The online version of the CAPP statistical handbook contains only the drilling distance statistics for the current year. Copies of data from past handbooks must be requested directly from CAPP for the years 1993 to 2010 [22]. Table 6 relates these hard to acquire numbers.

As an example, in 2002 the total meters drilled for oil was $0.71 \text{ e}^6 + 4.65 \text{ e}^6 = 5.36 \text{ e}^6$ meters and the total meters drilled for natural gas was $2.63 \text{ e}^6 + 6.02 \text{ e}^6 = 8.65 \text{ e}^6$. Natural gas was thus 61.7% of total drilling and so 61.7% of exploration and development expenditures would be apportioned to natural gas wells for 2002.

Exactly like the combined oil and gas method, royalties and land expenditures were removed.

Table 6. Meters drilled for oil and gas in Western Canada by year (10 e⁶ meters)

Year	Exploratory		Development	
	Oil	Gas	Oil	Gas
1993	0.93	1.16	4.32	1.90
1994	1.04	2.22	4.09	3.12
1995	0.83	1.46	4.88	2.08
1996	0.97	1.29	6.34	2.57
1997	1.23	1.43	8.41	3.90
1998	0.87	2.14	3.10	3.18
1999	0.63	2.37	3.33	4.70
2000	0.79	3.19	6.06	5.92
2001	0.81	3.57	5.23	6.90
2002	0.71	2.63	4.65	6.02
2003	0.71	2.84	5.29	8.65
2004	0.79	3.96	4.91	10.84
2005	1.07	4.88	6.51	12.63
2006	1.66	4.28	6.81	11.17
2007	1.05	1.93	5.97	8.26
2008	1.44	1.41	6.05	7.84
2009	0.64	0.87	4.37	4.25

3.12. Natural Gas Overhead Expenditures

The oil and gas well lease and gas plant overhead expenditure statistics are also intermingled. To apportion these amounts, it was assumed that expense is directly related to energy produced following a NEB technique for estimating the cost per GJ of energy produced in Western Canada [9]. The overhead expenditure amounts were split by percentage of gas-related energy production vs. oil-related

Sustainability 2011, 3

energy production. For example, in 2002 $10.14 \text{ e}^9 \text{ GJ}$ of oil & natural gas was produced and 6.79 e^9 came from natural gas wells only. Natural gas was thus 66.9% of GJ delivered and thus 66.9% of overhead expenditures were apportioned to natural gas.

3.13. Natural Gas Well Results and Example

The net energy and EROI results are shown in Table 2 of Section 2.2. The energy invested for the year 2002 was $270 \text{ e}^6 \text{ GJ} = \$11.25 \text{ e}^9 \times 24 \text{ MJ}/\$$. The net energy was $6.52 \text{ e}^9 \text{ GJ} = 6.79 \text{ e}^9 \text{ GJ} - 0.270 \text{ e}^9 \text{ GJ}$ (note scale change of 270). The $\text{EROI}_{25} = 6.79 \text{ e}^9 \text{ GJ} / 0.270 \text{ e}^9 \text{ GJ}$.

3.14. Method Three: EROI of Western Canadian Natural Gas Using Estimated Ultimate Recovery

The goal of this method was the match each year's drilling expenditures with the estimated amount of gas that would eventually be produced from that same year's wells. The Canadian National Energy Board (NEB) calculates an estimate of the amount of natural gas that will be produced by each year's wells, as described below. This estimate was used instead of the CAPP statistical handbook. The energy input was again calculated from the year's expenses, but with a slightly different apportionment between oil and gas wells.

3.15. NEB Estimated Ultimate Recovery

The NEB estimates the amount of natural gas that will be produced from each year's wells as part of their efforts to forecast production. They do this by collecting historical well production data and then fitting a decline curve to each well to predict when each well's production rate will decline to zero and the amount of natural gas produced at that point. Figure 9 is an example of such a curve, taken from [9], which contains a full description of the NEB methodology. The vertical axis is the rate of gas flow and the horizontal axis is total gas produced. The decline curves are calculated from prior year's well performance for the same region.

The EUR for all the wells drilled in all regions is totaled for each year. The NEB also estimates the natural gas liquids (NGL) produced. The NEB converts production volume to energy. The resulting value is reported as the estimated energy recovery and is the value this method uses for energy output. The NEB staff kindly provided updated values through 2008.

3.16. NEB Natural Gas Drilling Expenditures

The NEB provide their own estimate of natural gas well exploration and development (E&D) costs based on the CAPP statistics (which mix oil and gas production) but they use a different secondary statistic to apportion the expense dollars. Instead of the total meters of natural gas vs. oil wells drilled that this paper used in method two, the NEB used private data to add up the total number of days that drilling rigs spent drilling wells targeting natural gas (gas-intent drill days) vs. the days the drilling rigs spent drilling oil wells. The ratio of gas intent drill days vs. oil intent drill days was used to apportion the E&D expenses. The NEB method was followed here, except the NEB estimated E&D cost contains land acquisition and royalty costs that were excluded in prior methods. Removing these costs required

Sustainability 2011, 3

comparing the NEB results to the original CAPP statistics and recreating the gas vs. oil ratio. The land and royalties were removed and the ratio reapplied. This allows a more direct comparison of results.

Each year's recalculated E&D cost was divided by the same year's EUR to give a resulting E&D cost per GJ of energy.

Figure 9. Well production decline analysis example from NEB [9].

Example of Average Connection Production Decline Analysis Plot, Conventional Gas Connections, Alberta Foothills Front, 1999 Connection Year

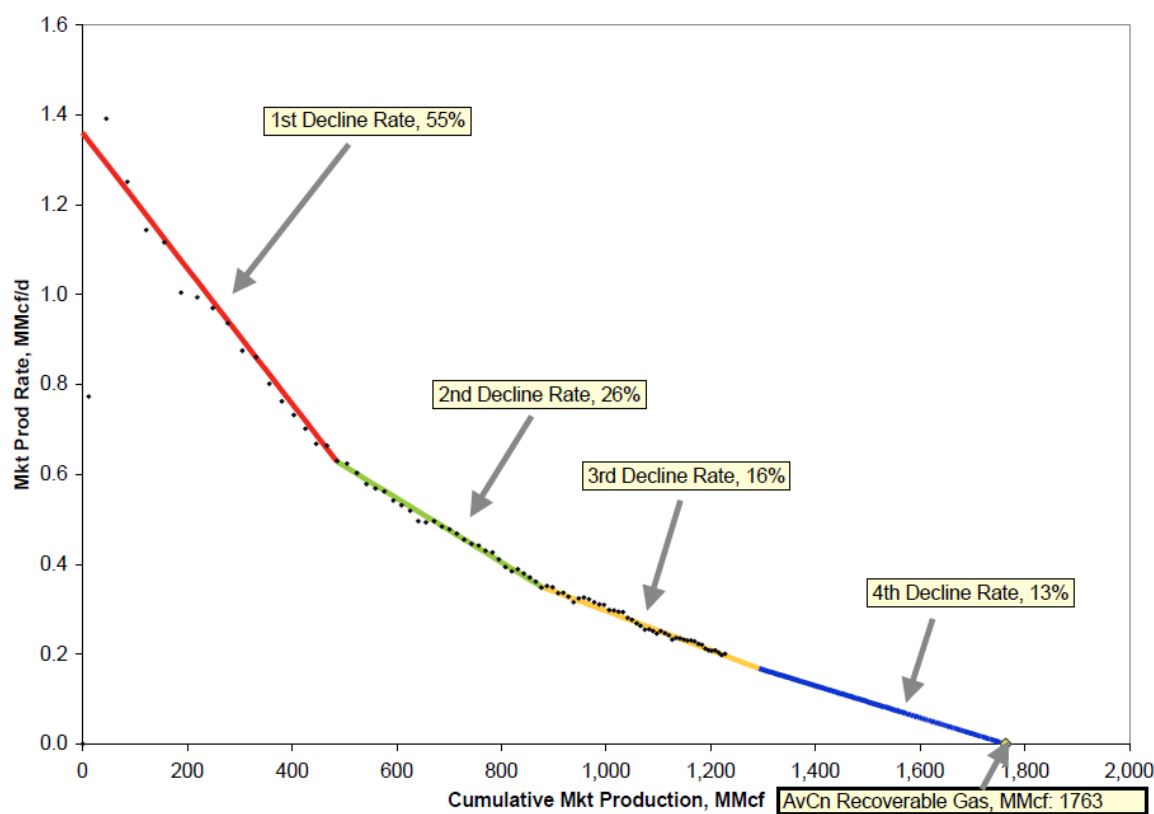

Source: NEB analysis of GeoScout well production data

3.17. NEB Natural Gas Operating Expenditures

The operating cost was determined by summing all oil and gas production converted to heat energy and dividing by the total operating cost to determine an operating cost per GJ of energy produced. This is the same as method two for natural gas only.

3.18. Natural Gas EUR Net Energy and EROI

The costs were inflation adjusted and converted to U.S. dollars as in the prior methods. The results are reported in Tables 3 and 4 of Section 2.3. For the year 2002 the exploration and development cost was $\$1.19 / \text{GJ} = \$6.68 \text{ e}^9 / 5.63 \text{ e}^9 \text{ GJ}$. The operating expense was $\$0.56 / \text{GJ} = \$8.75 \text{ e}^9 / 10.02 \text{ e}^9 \text{ GJ}$.

The E&D cost per GJ and the operating cost per GJ were summed. The resulting total expenditure was converted to energy using the $24\text{MJ}/\text{\$(U.S. 2002)}$ energy intensity value. This resulted in a ratio of

Energy Input/Energy Output which is the inverse of EROI. The results were inverted to provide EROI. EROI and net energy are reported in Table 4 of Section 2.3. As an example, for 2002, the total cost was $\$1.74 / \text{GJ} = \$1.19 + \$0.56$. The energy invested was $42 \text{ MJ} / \text{GJ} = \$1.74 / \text{GJ} \times 24 \text{ MJ}/\$$. The EROI of $24 = 1 \text{ GJ} / 0.042 \text{ GJ}$ (note the scale change of 42). And the net energy is $5.39 \text{ e}^9 \text{ GJ} = 5.63 \text{ e}^9 - (0.042 \times 5.63 \text{ e}^9 \text{ GJ})$.

4. Conclusions

This study has calculated the EROI and net energy of the Western Canadian petroleum and natural gas production by a variety of methods and the results suggest several conclusions.

4.1. The Current State of Western Canadian Natural Gas and Oil Production

All of three methods show a downward trend in EROI during the last decade (Figure 10) and the combined oil and gas industry has fallen from a long term high EROI of 79:1 (about 1% energy consumed) to a low of 15:1 (7% energy consumed) (Figure 5).

Figure 10. EROI comparison according to technique.

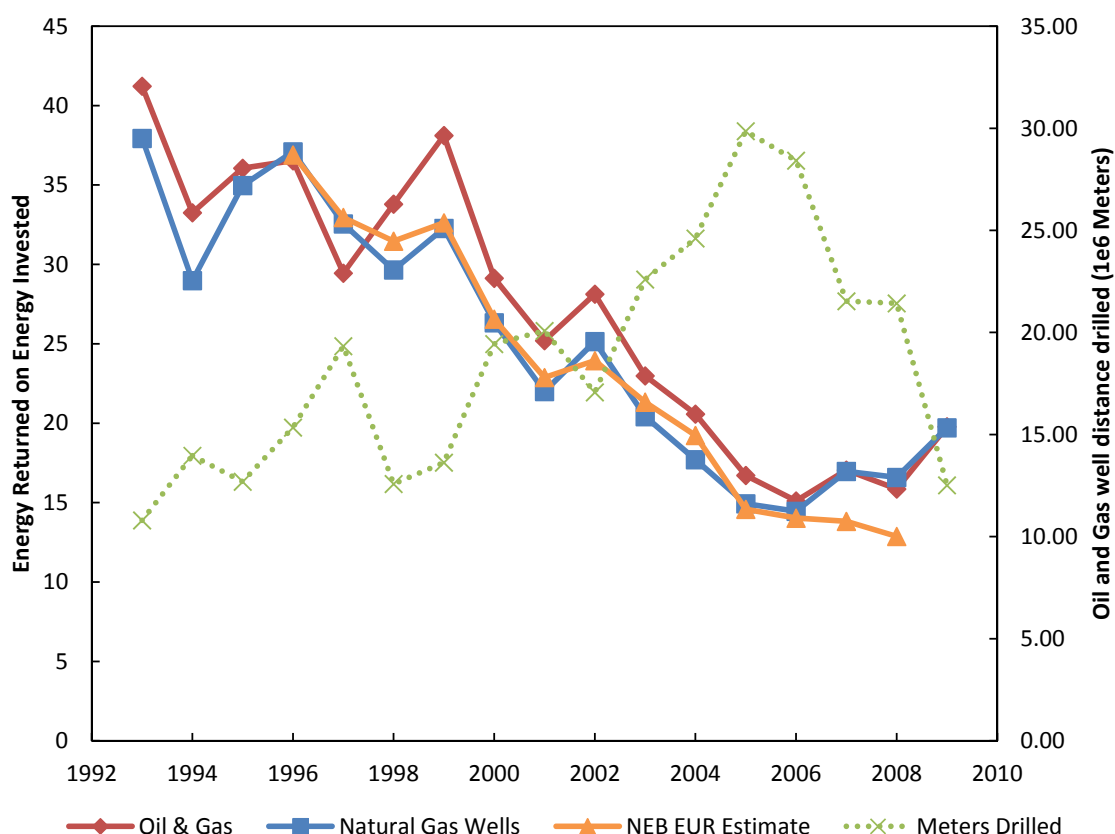

Natural gas EROI reached an even deeper low of 14:1 (7%) or even 13:1 (8%) with the NEB EUR method. It is clear that state of the art conventional oil & natural gas extraction is unable to improve drilling efficiency as fast as depletion is reducing well quality. The fact that EROI does not rebound to match prior drilling rates and the EUR result shows no rebound indicates that well quality continues

to decline. The small rebound in EROI is an result of the rolling average technique of methods one and two.

The conventional oil and gas in the WCSB has peaked. Falling well quality will likely continue to push cost up or production down. The economies that depend on this region now find themselves in the situation illustrated by Figure 1 column B, where their net energy has contracted and they will need to take action to find alternate energy supplies or improve efficiency of use.

4.2. The Net Energy Dynamics of Peak Production

The overall pattern shows a rising EROI during the early stages of exploitation followed by a peak in EROI and then declining production (Figure 5). This pattern shows the falsehood of the idea that additional investment always results in increased production. During the initial rising EROI phase, flat or falling drilling rates can increase production, and during the falling EROI phase, production can fall despite dramatic increases in investment.

There appears to be a maximum energy investment that can be sustained, which is about 15:1 to 22:1 EROI or 5% to 7% of gross energy. This might indicate a minimum EROI that can be supported while the economy grows. The minimum was higher for the oil peak than the natural gas peak and this might have been caused by inexpensive imported oil or because the economy had become more energy efficient (Figure 1 column C) allowing a lower minimum EROI.

The natural gas and oil peaks differed when analyzed using net energy. The oil peak had a peak in gross and net energy on the same year, suggesting that some outside factor was responsible for reducing investment. Natural gas showed a net energy peak before a gross production peak. This suggests that price was not the limiting factor in reducing drilling effort. Instead, from 1996 to 2005, the drilling rate for natural gas quadrupled and expenditures rose even faster, despite falling net energy and this in turn suggests that it was falling net energy was the eventual cause of economic contraction and falling prices.

A peak in net energy may be the best definition of “peak” production. When net energy peaks before gross energy it indicates that price was not the limiting factor in the effort to liberate energy. This is a likely model of world net energy production where less expensive imported energy sources cannot replace existing but declining energy sources.

A rise in EROI appears to be possible only when a new resource or region is being exploited, such as the transition from oil to gas as the primary energy production in the WCSB during the late 1980s. This study has focused on conventional natural gas production and it is very uncertain how exploitation of shale gas reserves will change the energy return.

4.3. Wider Implications

Some wider conclusions about renewable energy are suggested by this net energy study. If there is a maximum level of investment between 5% and 7% of gross energy, then economic growth may not be possible if more energy is diverted into the energy producing sector. If this minimum exists then it places a lower bound EROI on any energy source that is expected to become a major component of societies’ future energy mix. For instance, nuclear power with its low EROI is likely below this level [25,26].

Also, if the maximum level of investment is 7% of output energy consumed and a renewable energy source has an EROI of 20:1, or 5%, then the 2% remaining is the maximum that may be invested into growth of the energy source without causing the economy to decline. This radically reduces the rate at which society may change the energy mix that supports it [27].

This study does not attempt to estimate the EROI or net energy of shale gas, but some caution is warranted by comparison between these results and some cursory findings for the cost of shale gas. The International Energy Agency's World Energy Outlook 2009 contained a graph showing the cost of natural gas production in the Barnett Shale (Figure 11). The core (best) counties, Johnson and Tarrant, show the lowest cost while counties outside the core production region show higher costs.

Figure 11. Cost per million Btu in the Barnett Shale for 10% ROI. Taken from the IEA WEO 2009 [28].

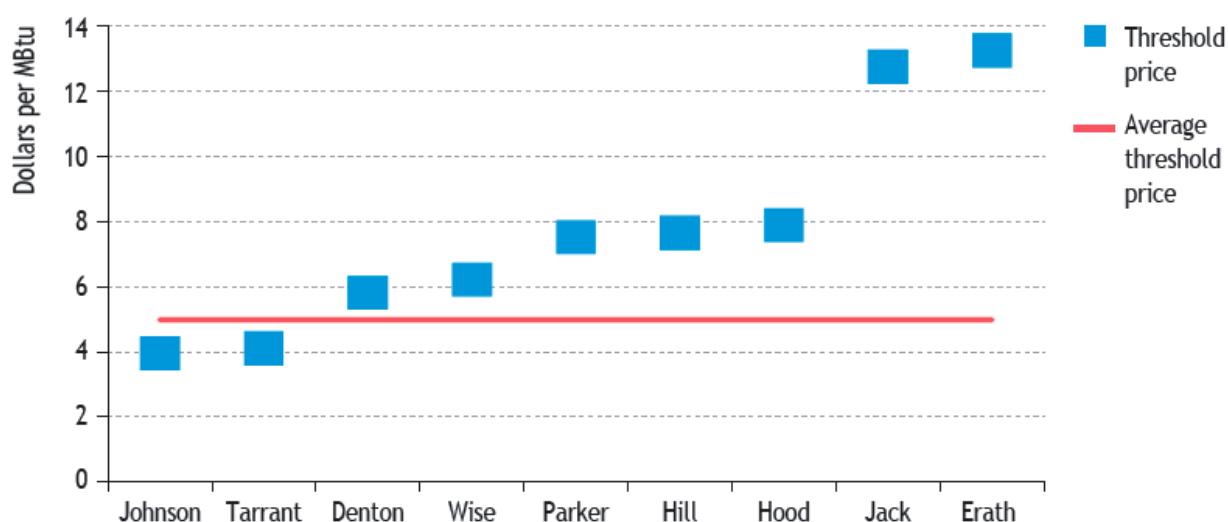

Note: Assumes US fiscal costs; a discount rate of 10%; capital costs of \$3 million per well; leasehold costs of \$225 000 per well; a royalty rate of 12.5%; and operating expenses of \$18 000 per mcm.

Sources: Powell (2009); IEA databases and analysis.

A very rough comparison can be made to the costs in this report. If the royalty amounts are subtracted and inflation adjusted into \$2002 values, the Johnson County cost would be \$2.94 resulting in an EROI of roughly 15:1 (7% of output consumed). This is not much higher than the lowest EROI values found in the WCSB. All the remaining Barnett Shale costs are much higher. Hill and Hood would have an EROI of 8:1 and Jack and Erath would have an EROI of roughly 5:1 (22% of output energy consumed in extraction). Given the history of the WCSB production peaks, it is hard to see how shale gas production could be much increased with such low net energy values. Shale gas may have a very short lived EROI increase over conventional while the core counties are exploited and then suffer a production collapse as EROI falls rapidly. This would fit the pattern seen with oil and then with natural gas in the WCSB.

The IEA WEO 2009 also contains Figure 12, an illustration of a world view that increasing cost will liberate more and more energy for use by society.

Figure 12. Modified from the IEA WEO 2009 [28] with dotted lines added to illustrate concept of net energy reducing the total volume of energy available as resource quality declines.

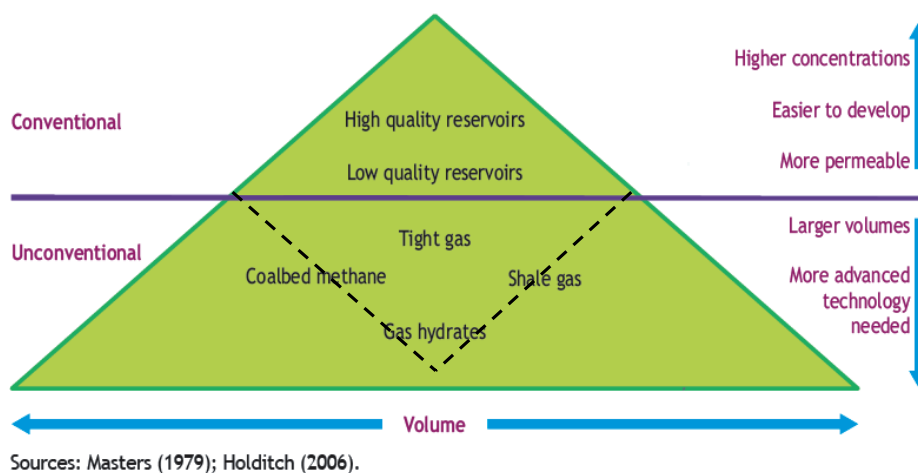

Conventional gas reservoirs, now peaked in production and shrinking in the WCSB, are seen as the small tip of a huge number of other resources that could be liberated with increasing investment. But falling net energy may prove this view false. If the energy return is too low, production growth may be limited or impossible from many of these energy sources. Much of the energy produced may need to be consumed during extraction. The proper shape of this diagram is likely to be a diamond with non-conventional resources forming a smaller part of the diamond underneath as denoted by the added dotted lines.

Acknowledgements

Thank you to the staff of the NEB and CAPP who patiently answered questions and supplied missing data points and to Bryan Sell for constructive comments and supporting material. Thank you to the anonymous reviewer who also provided excellent comments and to Charlie Hall and Doug Hansen for their patient support. And thanks to Nate Hagens for introducing the concept of EROI to a wide audience.

References and Notes

1. International Energy Statistics: Natural Gas Production. <http://www.eia.gov/cfapps/ipdbproject/IEDIndex3.cfm?tid=3&pid=3&aid=1> (accessed on 9 October 2011).
2. Hall, C.A.S.; Powers, R.; Schoenberg, W. Peak Oil, EROI, investments and the economy in an uncertain future. In *Biofuels, Solar and Wind as Renewable Energy Systems*, 1st ed.; Pimentel, D., Ed.; Springer: Berlin, Germany, 2008; pp. 109-132.
3. Downey, M. *Oil 101*, 1st ed.; Wooden Table Press: New York, NY, USA, 2009; p. 452.
4. Hamilton, J.D. Historical oil shocks. *Nat. Bur. Econ. Res. Work. Pap. Ser.* **2011**, 16790.
5. Carruth, A.A.; Hooker, M.A.; Oswald, A.J. Unemployment equilibria and input prices: Theory and evidence from the United States. *Rev. Econ. Stat.* **1998**, *80*, 621-628.

6. Hall, C.A.S.; Balogh, S.; Murphy, D.J.R. What is the minimum EROI that a sustainable society must have? *Energies* **2009**, *2*, 25-47.
7. *Canada's Energy Future: Infrastructure changes and challenges to 2020—An Energy Market Assessment October 2009*; Technical Report Number NE23-153/2009E-PDF; National Energy Board: Calgary, Alberta, Canada, 2010.
8. *Short-term Canadian Natural Gas Deliverability 2007-2009*; Technical Report Number NE2-1/2007E; National Energy Board: Calgary, Alberta, Canada, **2007**. Available online: <http://www.neb-one.gc.ca/clf-nsi/rnrgynfmitn/nrgyrprt/ntrlgs/ntrlgsdlvrblty20072009/ntrlgsdlvrblty20072009-eng.html> (accessed on January 1, 2008)
9. *Short-term Canadian Natural Gas Deliverability 2007-2009 Appendices*; NE2-1/2007-1E-PDF; National Energy Board: Calgary, Alberta, Canada, 2007. Available online: <http://www.neb-one.gc.ca/clf-nsi/rnrgynfmitn/nrgyrprt/ntrlgs/ntrlgsdlvrblty20072009/ntrlgsdlvrblty20072009ppndc-eng.pdf> (accessed on February 9, 2008)
10. Johnson, M. Energy Supply Team, National Energy Board, 444 Seventh Avenue SW, Calgary, Alberta, T2P 0X8, Canada; Personal communication, 2010.
11. *Natural Gas Potential in Canada – 2005 (CGPC – 2005)*. Executive Summary; Canadian Natural Gas Potential Committee: Calgary, Alberta, Canada, **2006**. Available online: <http://www.centreforenergy.com/documents/545.pdf> (accessed on October 1, 2010)
12. Murphy, D.J.; Hall, C.A.S. Order from chaos: A preliminary protocol for determining EROI of fuels. *Sustainability* 2011, *3*, 1888-1907.
13. *2009 Reference Case Scenario: Canadian Energy Demand and Supply to 2020—An Energy Market Assessment*. Appendixes; National Energy Board: Calgary, Alberta, Canada, **2009**. Available online: <http://www.neb.gc.ca/clf-nsi/rnrgynfmitn/nrgyrprt/nrgyft/2009/rfrncsscnr2009ppndc-eng.zip> (accessed on September 7, 2010)
14. Hall, C.; Kaufman, E.; Walker, S.; Yen, D. Efficiency of energy delivery systems: II. Estimating energy costs of capital equipment. *Environ. Manag.* **1979**, *3*, 505-510.
15. Bullard, C. The energy cost of goods and services. *Energ. Pol.* **1975**, *3*, 268-278.
16. Cleveland, C. Net energy from the extraction of oil and gas in the United States. *Energy* **2005**, *30*, 769-782.
17. Hendrickson, C.T.; Lave, L.B.; Matthews, H.S. *Environmental Life Cycle Assessment of Goods and Services: An Input-Output Approach*; RFF Press: Washington, DC, USA, 2006; p. 272.
18. Carnegie Mellon University Green Design Institute Economic Input-Output Life Cycle Assessment (EIO-LCA), USA 1997 Industry Benchmark model. Available online: <http://www.eiolca.net> (accessed on October 1, 2010).
19. *Crude Petroleum and Natural Gas Extraction: 2002, 2002 Economic Census, Mining, Industry Series*; EC02-21I-211111; U.S. Census Bureau: Washington, DC, USA, 2004.
20. *Natural Gas Liquid Extraction: 2002, 2002 Economic Census, Mining, Industry Series*; EC02-21I-211112; U.S. Census Bureau: Washington, DC, USA, Appendices..
21. Gagnon, N.; Hall, C.A.S.; Brinker, L. A preliminary investigation of energy return on energy investment for global oil and gas production. *Energies* **2009**, *2*, 490-503.
22. Canadian Petroleum Association. *Statistical Handbook for Canada's Upstream Petroleum Industry*; Canadian Association of Petroleum Producers: Calgary, Canada, 2010.

23. Statistics Canada Table 326-0021 Consumer Price Index (CPI), 2005 basket, annual (2002 = 100 unless otherwise noted). Available online: <http://www.statcan.gc.ca/start-debut-eng.html> (accessed on 20 September 2010).
24. Annual Average of Exchange Rates 2002. Available online: http://www.cra-arc.gc.ca/tx/ndvdl/fq/xchng_rt-eng.html (accessed on October 23, 2010)
25. Lenzen, M. Life cycle energy and greenhouse gas emissions of nuclear energy: A review. *Energy Convers. Manag.* **2008**, *49*, 2178-2199.
26. Pearce, J.M. Thermodynamic limitations to nuclear energy deployment as a greenhouse gas mitigation technology. *Int. J. Nucl. Govern. Econ. Ecol.* **2008**, *2*, 113-130.
27. Mathur, J.; Bansal, N.K.; Wagner, H.-J. Dynamic energy analysis to assess maximum growth rates in developing power generation capacity: Case study of India. *Energ. Policy* **2004**, *32*, 281-287.
28. Gas Resources, Technology and Production Profiles, Chapter 11. *World Energy Outlook 2009*; International Energy Agency: Paris, France, 2009.

© 2011 by the authors; licensee MDPI, Basel, Switzerland. This article is an open access article distributed under the terms and conditions of the Creative Commons Attribution license (<http://creativecommons.org/licenses/by/3.0/>).

Article

Energy Return on Energy Invested for Tight Gas Wells in the Appalachian Basin, United States of America

Bryan Sell ^{1,*}, David Murphy ² and Charles A.S. Hall ²

¹ Section of Earth and Environmental Sciences, University of Geneva, Rue des Maraîchers 13, Geneva 1205, Switzerland

² Program in Environmental Science, State University of New York – College of Environmental Science and Forestry, Syracuse, NY 13210, USA; E-Mails: djmurp03@esf.edu (D.M.); chall@esf.edu (C.H.)

* Author to whom correspondence should be addressed; E-Mail: Bryan.Sell@unige.ch; Tel.: +41-78-883-72-42; Fax: +41-22-379-32-10.

Received: 26 June 2011; in revised form: 7 July 2011 / Accepted: 5 August 2011 /

Published: 20 October 2011

Abstract: The energy cost of drilling a natural gas well has never been publicly addressed in terms of the actual fuels and energy required to generate the physical materials consumed in construction. Part of the reason for this is that drilling practices are typically regarded as proprietary; hence the required information is difficult to obtain. We propose that conventional tight gas wells that have marginal production characteristics provide a baseline for energy return on energy invested (EROI) analyses. To develop an understanding of baseline energy requirements for natural gas extraction, we examined production from a mature shallow gas field composed of vertical wells in Pennsylvania and materials used in the drilling and completion of individual wells. The data were derived from state maintained databases and reports, personal experience as a production geologist, personal interviews with industry representatives, and literature sources. We examined only the “upstream” energy cost of providing gas and provide a minimal estimate of energy cost because of uncertainty about some inputs. Of the materials examined, steel and diesel fuel accounted for more than two-thirds of the energy cost for well construction. Average energy cost per foot for a tight gas well in Indiana County is 0.59 GJ per foot. Available production data for this natural gas play was used to calculate energy return on energy invested ratios (EROI) between 67:1 and 120:1, which depends mostly on the amount of materials consumed, drilling time, and highly variable production. Accounting for such

inputs as chemicals used in well treatment, materials used to construct drill bits and drill pipe, post-gathering pipeline construction, and well completion maintenance would decrease EROI by an unknown amount. This study provides energy constraints at the single-well scale for the energy requirements for drilling in geologically simple systems. The energy and monetary costs of wells from Indiana County, Pennsylvania are useful for constructing an EROI model of United States natural gas production, which suggests a peak in the EROI of gas production, has already occurred twice in the past century.

Keywords: EROI; natural gas; tight gas; Appalachian Basin; Indiana County; depletion

1. Introduction

Natural gas now dominates the well-derived fossil fuel production of the United States; the number of wells drilled for natural gas overtook the number of wells drilled for crude oil in 1993 and now accounts for nearly 70% of the wells drilled annually [1]. Natural gas is currently the most widely used fuel by the manufacturing industry in the United States [2]. Before natural gas rose to prominence, disturbances in the natural gas market such as the U.S. gas shortage of the 1970s and the gas oversupply of the 1980s had significant effects on national economies [3]. Similar global effects are expected to occur in the near future [4], although others tend to disagree [5]. Another natural gas crisis seems likely given the unprecedented rise in U.S. natural gas well cost compared to the decrease in production per well, *i.e.*, well costs are climbing at an exponential rate while production per well is decreasing at a linear rate. Conventional economics appears to have failed at making accurate predictions on energy resource availability [6]. Thus it becomes prudent to analyze energy resources in terms of physical constraints and requirements. This situation is more serious if we consider arguments about whether the most important fields have reached maturity and are in decline, *i.e.*, peak gas [4].

Traditionally, discussion over whether gas reserves (and oil) are in decline rely on monetary based data [7,8] and aggregate production data from multiple fields [9-11], but typically do not address how to detect whether a particular field is in physical decline. Notable exceptions can be found with recent depletion analysis studies of individual oil fields [12-14] and for large gas fields in Europe [15] that show peak production occurring at or soon after one-half of the ultimate reserves are produced followed by increasingly high decline rates. While it is tempting to assume that the same trends apply to all natural gas fields, a similar decline analysis for U.S. natural gas apparently has yet to be performed. Knowing the decline characteristics for natural gas in a given area is essential for economic planning regardless of a peak gas scenario. However, different interpretations can be made about the same production data [8,9].

We propose a different approach for detecting whether a natural gas field is declining by examining individual well decline characteristics and the requirements for exploiting natural gas at the single-well scale. This approach makes sense because the overall decline rate of a given field should be controlled by the sum of the decline rates of individual wells and the energy requirements for drilling will physically and economically constrain the life of a given field. As a first step in understanding the

limitations of natural gas reserves, the oldest and most mature fields that contain relatively inexpensive wells, such as those found in the Appalachian Basin, should be examined.

The purpose of this research is to examine the energy requirements for drilling a natural gas well compared to the energy produced, *i.e.*, a net energy analysis or an energy return on investment (EROI). We examine how much material and their energetic equivalents are required to drill a natural gas well in the Bradford-Venango-Elk (BVE) natural gas field in Indiana County, Pennsylvania. Material requirements and resource production are examined over time in order to detect whether technology and drilling parameters affect production. The resulting information can then be used as a constraint when considering other natural gas resources in terms of their economic viability.

There are several advantages for choosing this area for EROI analysis. First, these wells are unique because they are near or already classified as marginally productive as soon as they are drilled and thus are extremely vulnerable to being abandoned or not drilled when the market price of petroleum decreases [16]. Thus, any estimates made for these wells could be considered a baseline estimate for other, more profitable wells. Second, this heavily drilled area represents one of the largest tight gas plays in the United States (Figure 1). Pennsylvania has the largest number of marginal gas wells of any state and produces the 4th largest quantity of marginal gas in the United States after West Virginia, Oklahoma, and Texas [16]. EROI could predict the future of this important natural gas resource by stating the energy requirements for exploitation. Third, Indiana County, Pennsylvania has over 100 years of natural gas exploration history and is densely populated with vertical natural gas wells (Figure 2), most of which have similar total depths, *i.e.*, the natural gas system of this area is relatively well constrained (Figure 3). This long history [17] could serve as a useful comparison to other gas fields and possibly provide an indication as what to expect from the total gas supply of North America and beyond.

Figure 1. Tight gas plays in the United States. The different colors represent different groups of rocks that compose the various tight gas plays of the United States. The dark brown polygon in the northeast U.S. represents the Bradford-Venango-Elk tight gas play.

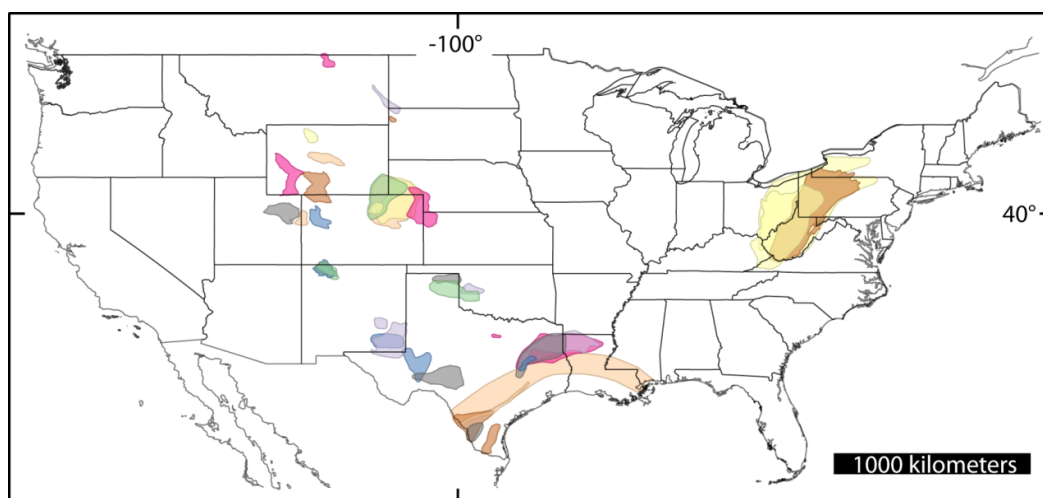

Figure 2. Map showing the Bradford-Venango-Elk (BVE) tight gas play (inset) and the distribution of all BVE wells in Indiana County, Pennsylvania, U.S. Yellow squares represent well locations examined for materials used. Red squares represent all wells that have available production records. The black squares represent all wells BVE play wells drilled in Indiana County.

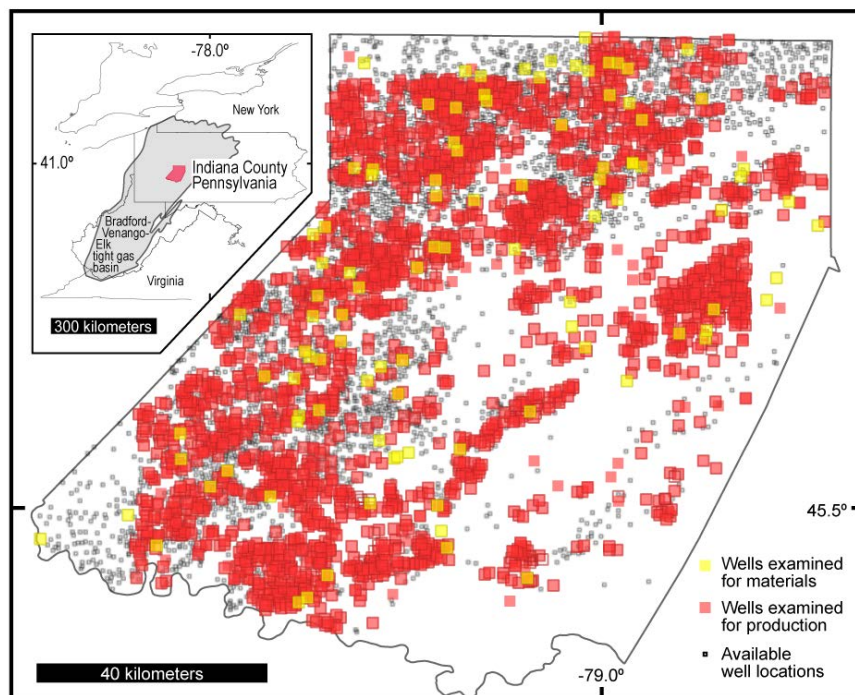
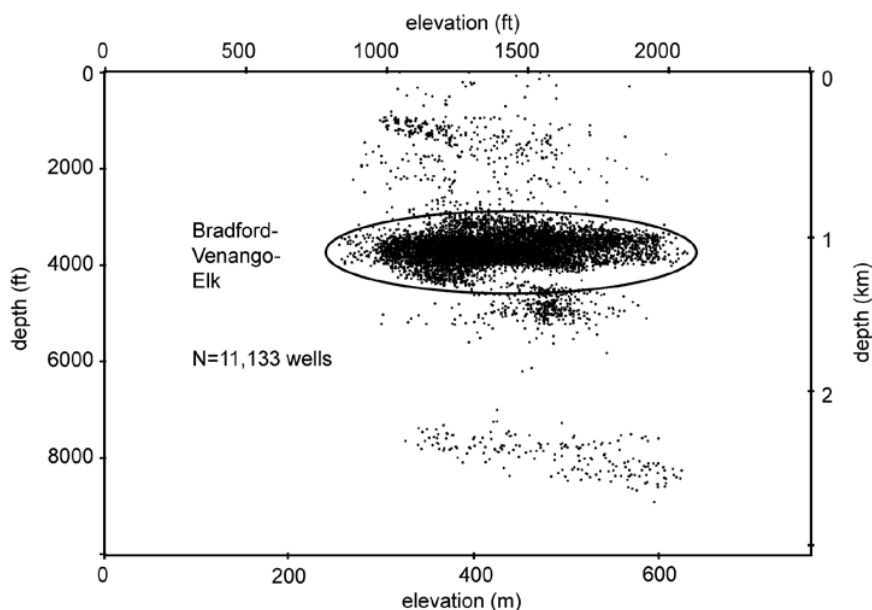

Figure 3. Depth-distribution of BVE wells. Elevation is that above sea level. Data are from the Pennsylvania Department of Conservation and Natural Resources (PADCNR). Wells have been drilled to other formations but 97% have been drilled to the depths of the Bradford, Venango, and Elk Formations.



1.1. Drilling and Production History

The Bradford, Venango, and Elk plays (Figure 2) are tight natural gas formations that encompass the western half of Pennsylvania, northern half of West Virginia and small portions of Virginia, Kentucky, Ohio, and New York [1]. All three plays comprise the BVE natural gas basin (Figure 1). Indiana County is roughly within the center of the main drilling area of the BVE field. It is useful for context to note that in 2007 there were approximately nine residents for every natural gas well in Indiana County, Pennsylvania. Of the 10,468 Indiana County wells on file at the Pennsylvania Department of Conservation and Natural Resources (PADCNR) as of March 2007, 97% were completed in the BVE natural gas play (Figure 3). The average depth of these wells is 1106 meters (3630 feet). The first BVE well in Indiana County was drilled in 1878 with peak number of wells (565) drilled in 1981 (Figure 4). After 1981, drilling intensity decreased rapidly until 1990 and is increasing steadily to this date. The market price of natural gas appears to have been the major driver in Indiana County's natural gas development (Figure 4).

Figure 4. Production and drilling history for BVE wells in Indiana County, Pennsylvania compared with the wellhead price per Mcf of natural gas. Price data are from the U.S. Energy Information Agency (EIA) [1]. Production and well data are from the PADCNR [18].

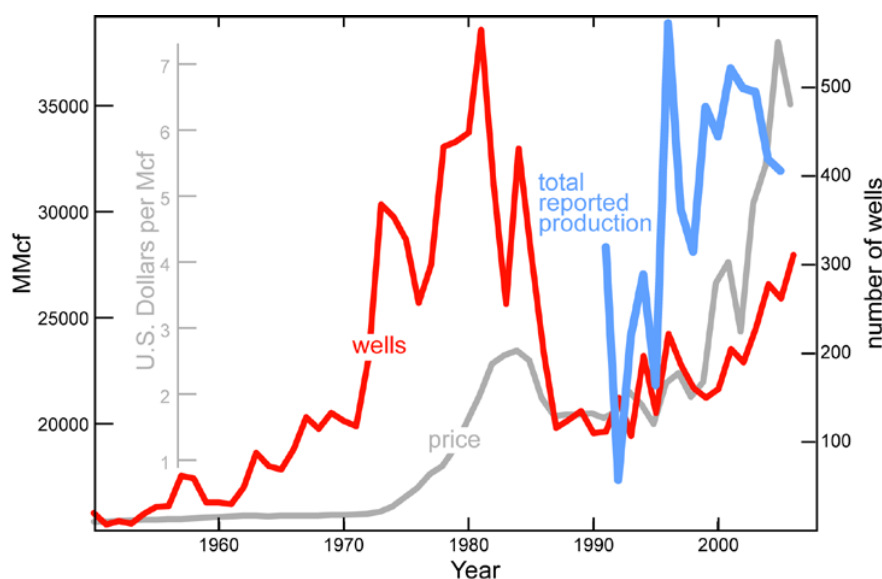

The BVE play is composed of multiple thin layers of siltstone and sandstone with low natural porosity. This type of formation requires the rock to be artificially fractured and eroded with explosive charges and high-pressure water containing various acidic chemicals. During this fracturing procedure sand is simultaneously pumped into the well as a material that acts as a prop (*i.e.*, proppant) that holds open the artificial fractures.

Available production data from the PADCNR on the BVE natural gas play in Indiana, PA, dates back to 1980 with fewer than 100 reporting for the first ten years [18]. Between 1991 and 2001, between 5,000 and 7,000 wells were reported each year (Figure 4). For each year since 1991, natural gas from Indiana County has accounted for approximately 23% of the total gas produced in

Pennsylvania. During this same time, the number of wells drilled account for 20% of all wells drilled in Pennsylvania. Total production increased each year, however average production per well decreased between 1990 and 2005 (Figure 5). Average production per well for 20 years was reported [19] with average initial production per well at 28.5 MMcf (78.1 Mcf per day) decreasing to less than 5.0 MMcf after 16 years. Of all wells drilled in Indiana County, approximately 97% are successful natural gas producers. Unsuccessful wells typically have their production tubing removed, plugged with cement, and abandoned.

Figure 5. Average production per well between 1991 and 2005. The values were determined by dividing the number of wells drilled in a given years by the total production. Production and well data are from the PADCNr [18].

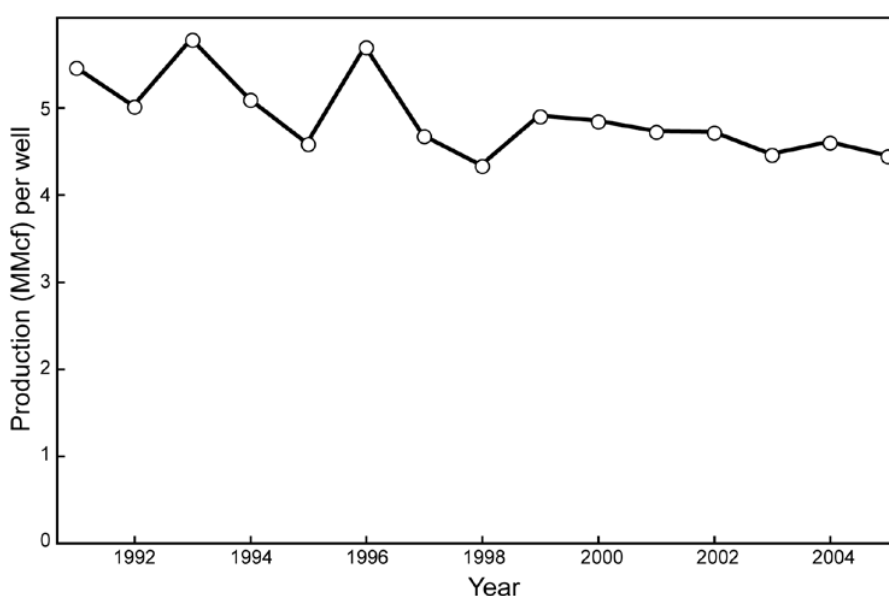

2. Data Collection Methods

Individual well costs are difficult to obtain because of proprietary restrictions on such data [20]. Summary reports on monetary costs are available from the U.S. Department of Energy, but these reports do not provide details on amounts of materials used. Despite these issues we obtained well information that includes location, total depth, and materials emplaced in the borehole for natural gas wells from archives maintained by the PADCNr. This allowed assessment of what comprises a typical well in this Indiana County. From the well information list in the PADCNr archive, 101 gas wells drilled between 1965 and 2004 were randomly selected using a random function in Microsoft® Excel X for Mac® for examination of materials used in drilling and completion. The wells were randomly selected in this way because it was not possible to convert all completion reports into a useable dataset while selecting completion reports that would cover a broad geographic area of the county. The selected wells appear to give an adequate geographic coverage. Wells that were abandoned after drilling because of a lack of natural gas, *i.e.*, dry holes, are not included in this study. Materials consumed in natural gas well drilling were taken from well completion reports maintained by the PADCNr (Table 1). The reports for each well lists the amount of steel casing and tubing, cement, and

fracturing fluids and proppants (sand) used in the construction of the well. Approximate diesel fuel consumption used in drilling and completion of the well were derived from personal interviews and checked against industry publications [21]. Drilling and completion diesel fuel numbers were derived from personal sources at drilling and well service companies in Indiana County and from private company reports for fuel use in other natural gas producing regions in the United States.

Table 1. Materials list for a typical natural gas well in Indiana County, Pennsylvania, with a depth of 3710 feet.

Materials	Amount	Total Energy per well (GJ)
Average casing and tubing weight (U.S. short tons)	31.88	1037
Average cement (U.S. short tons)	22.69	127
Average stimulation Water (gallons)	74,099	?
Average proppant/sand (U.S. short tons)	144.82	3.77
Drilling diesel fuel (gallons/day)	450	886
Completion diesel fuel (gallons/day)	900	135
Average well completion time (days)	13.1	–
Labor Cost	?	?
Average Production (Mcf) with 4% production loss	176,331	190,437
Conversions	Conversion units	References
Raw Steel	25.3 GJ/ton	[22-24]
Manufactured steel pipe	7.2 GJ/ton	[22-24]
Limestone mining	0.03 GJ/ton	[25]
Cement manufacturing	5.59 GJ/ton	[25,26]
Sand (aggregate) mining	0.03 GJ/ton	[25]
Diesel fuel energy content	0.15 GJ/gallon	[27]
Natural gas energy content	1.08 GJ/Mcf	[27]
Energy cost for drilling	0.59 GJ/foot	This study
Approximate dollar cost for drilling	\$51.00 /foot	[28]

United States Energy Information Agency data were downloaded from their website [1]. Data used in this study includes: (1) footage for all exploratory, development, and dry wells; (2) gross gas well withdrawals; (3) the number of natural gas exploratory and developmental wells drilled; and (4) nominal cost per foot of natural gas wells drilled. Data coverage is restricted to those wells drilled explicitly for natural gas—mixed wells that produce both natural gas and crude oil are excluded.

2.1. Deriving EROI

The EROI calculated here is for the mine mouth ($EROI_{mm}$) and takes into account the embodied energy found in materials consumed in well construction. Energy quality is not considered and other energy costs are ignored because we consider them minor with respect to the costs presented here, e.g., physical energy employed by workers. An EROI ratio, which is a first approximation of $EROI_{mm}$ is calculated for Indiana County using the following equation:

$$EROI_{BVE} = \frac{P-s}{S+C+p+D} \quad (1)$$

Production, P , and production loss from pipeline leaks, s , represent the energy returned. The energy equivalents of steel used in casing and tubing, S ; cement used in the well, C ; proppant used in fracturing, p ; and diesel fuel used in drilling and well treatment, D , represent the energy inputs. Other energy inputs can be added, but were not directly available for this study.

The energy requirements for the BVE play wells in Indiana County are assumed to be close to the minimum cost of drilling a natural gas well. The minimum energy requirement is 0.59 gigajoules per foot. This minimum energy cost per foot is used to calculate the average energy cost per foot, E_f , of natural gas extraction in the U.S. on the basis of monetary cost per foot (assuming that energy cost is approximately proportional to monetary cost and that energy costs for BVE wells in Indiana County have remained constant):

$$E_f = E_m \frac{C_{AN}}{C_m} \quad (2)$$

The minimum monetary cost per foot is C_m , which is equal to \$51.00 per foot for the year 2000, C_{AN} is the average monetary cost per foot for the nation (U.S.), and E_m is the minimum energy cost. This average energy cost per foot is then multiplied by the total footage drilled for a given year such that:

$$EROI_{US} = \frac{P_t}{E_f F} \quad (3)$$

The total production, P_t is from gross gas withdrawals, E_f is the average energy cost per foot, and F is the total footage drilled for all exploratory, development, and dry wells. In this EROI calculation the monetary and energy costs, footage drilled, and production are used to approximate an ratio for $EROI_{mm}$. Another indicator of the natural gas drilling effort that may useful is the total number of gas wells drilled per year. While admittedly speculative, we assume here that as the numbers of wells are increased there may be a corresponding increase in infrastructure. This infrastructure increase may be used to give an indication of energy inputs beyond the mine mouth boundary, *i.e.*, point if use ($EROI_{pou}$) as defined in the introductory portion of this volume. If so, then the number of wells drilled in a given year can be used as an approximation of transmission and processing costs and losses such that $EROI_{pou}$ for the U.S. may be estimated by:

$$EROI_{total} = \frac{P_t}{E_f F} * \frac{W_{by}}{W_t} \quad (4)$$

The number of wells drilled for a base year W_{by} is the same year used to derive real from nominal dollars. The number of wells drilled for any given year, W_t , divides the number of wells for the base year. The number of wells does not account for all infrastructure however, we use the number of wells drilled as a factor that takes into account the influence of field expansion and the required pipeline development. A more accurate calculation would add the energy costs of infrastructure, which is clearly not taken into account in our analyses.

2.2. Deriving Energy Intensities of Materials Used

To tally the energy costs of drilling and completing a BVE play well we examined the amounts of steel for casing and tubing, cement used to set the casing in the borehole, water and sand used for treating the well, and diesel fuel for all aspects of well construction. Many other materials, e.g., fuel for transporting personnel to the well site, are commonly used in the construction of a natural gas well. We consider the energy cost of these other materials as small compared to the entire energy cost of the proceeding materials and would make a minor contribution to the EROI calculation. This assumption appears reasonable after examining “application for expenditure” forms from private industry. Unfortunately, these forms contain proprietary information and cannot be published. Some other materials such as drill bits may make a significant contribution to energy cost of a well; however, reliable information on the manufacturing energy cost is not readily available. While we did tally the amount of water used (*i.e.*, fracture fluids), there was no clear way to arrive at an energy equivalent for water use.

Calculating the energy cost for making steel (Table 1) is difficult because it is unknown what quantity of secondary steel (*i.e.*, steel manufactured from scrap using electric arc furnaces) is used for casing and tubing. Secondary steel has been estimated to cost between 11.3 [22] and 11.8 GJ/ton [23]. For primary steel derived directly from iron ore the energy cost is estimated to be between 23.4 [22] and 26.0 GJ/ton [23]. According to Worrell [23] there appears to be a decrease in the average energy consumption by the steel industry per ton of product of almost 35% over a couple of years in the early 1980s, which should be considered when calculating the energy cost of a well at least prior to 1982. The decrease in average energy consumption is probably due to the closure of many older integrated steel mills and an increase in the number of mills that use recycled steel [23].

Also important to note is that several energy intensive materials required for steel making are excluded from the energy equivalents. Stubbles [22] points out that such excluded items include electrodes, ferroalloys, refractories, and imported direct reduced iron. Also excluded from the energy cost of steel is the mining cost of coal for coke and limestone for lime. According the U.S. Department of Energy [25], coal produced in the eastern United States is estimated to have an energy cost between 0.31 and 0.003 GJ per ton. Lime is used in the steel industry to remove impurities during the steel making process and comes from the thermal decomposition of calcium carbonate, *i.e.*, limestone. The process of mining and making lime is similar to that for cement, which has been estimated to have an energy cost of 5.3 GJ per ton [23]. Coke and lime requirements per ton of steel are 50 and 120 pounds, respectively [22]. Coke and lime combined adds only 0.3 GJ of energy cost to each ton of steel, which has a small effect on the final net energy requirements for natural gas well construction.

We could not find direct energy costs associated with the manufacturing of petroleum specific casing and tubing from steel in any published literature. However, the energy costs for forming and finishing, which includes manufactured pipe is estimated to be 7.2 gigajoules per ton [22,23]. This energy cost for petroleum specific tubing is likely to be more than basic structural tubing because of stringent requirements as outlined by the American Petroleum Institute.

The energy costs for producing crushed and broken limestone and other rocks are derived from a 2004 report to the U.S. Department of Energy on energy use in the mining industry [25]. The estimated energy costs of mining and processing limestone minus calcining (lime production) is 0.026 GJ per

ton. Cement manufacturing is energy intensive at 5.59 gigajoules per ton because of the heat needed to decompose calcium carbonate to lime [25,26]. Sand used as a proppant requires a specific grain size and grade that must be mined, crushed, sieved, and transported in a similar manner as limestone. Since we could find no studies on the energy requirements for sand production we use the same energy cost values as used for the mining of limestone.

The energy equivalent of natural gas is 1.08 GJ/Mcf [27]. Production for each well is measured at the wellhead. Most natural gases require processing to remove other liquid fuels and impurities, which results in a reduction of volume of the extracted natural gas. The U.S. Energy Information Administration estimates this volume reduction (shrinkage) to be approximately 4%, which we use to correct the energy produced at the wellhead since natural gas (methane) is what is being examined in this study. The diesel fuel energy equivalent is derived from the same report as the natural gas equivalents [27].

3. Results

Individual well production data from Indiana County are for the years 1984 through 2003 while material data are for the years between 1964 and 2005. On the basis of all available production data from 2486 wells (Figure 6), average production per well increased during the 1980s and then generally decreased or remained flat until the present. Average total production per well is 184 MMcf between the years 1985 and 2003. A log curve fitted to the average of all production data gives R^2 value equal to 0.97 (Figure 7). Average first year production data shows a decrease in production after 1988 (Figure 8). On the basis of subtle trends shown in Figure 6 and Figure 8 we grouped the wells to show multi-year trends that show decreasing average production (Figure 9). Wells were randomly selected using a spreadsheet random number function (Figure 2). On the basis of 101 wells, materials used in the well construction show no clear trends over time, but the time it takes to drill a well generally decreased between the 1960s and 1980s and remained flat until the present (Figure 10). Average natural gas production (Figure 7) and the average of materials consumed (Figure 10) were converted to their energy equivalents (Table 1). The average EROI for a gas well in the BVE tight gas play in Indiana County, Pennsylvania over this time period is 86.96 (Figure 11). Year to year production changes do not show a correlation with year-to-year changes in available data (see data appendix). EROI fluctuates with respect to well production and shows a general decline from the 1980s when the EROI was as high as 120:1 to 2003 when EROI was equal to 67:1 (Figure 12).

Figure 6. Average production profile for wells drilled each year between 1984 and 2002. Data from the PADCNR.

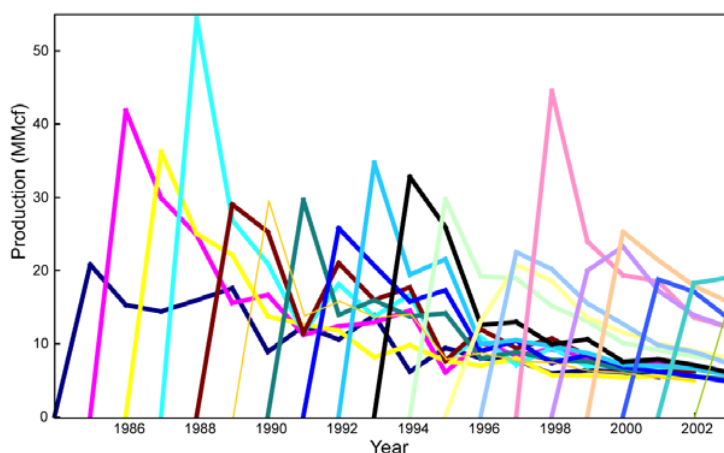

Figure 7. Production profile. All production data (total production over the life of a well) shown at a log scale with an average production curve fitted to the data. The y-axis is shown at a logarithmic scale in order to show the complete range of available production data. Downward deflection of older portion of curve is due to logarithmic decline.

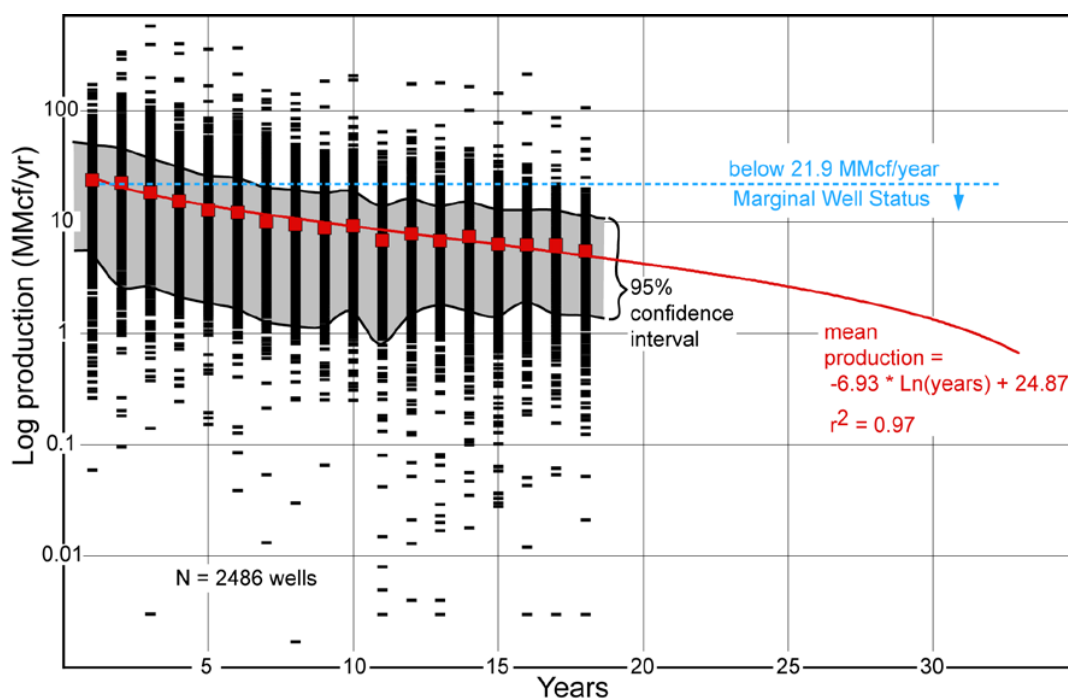

Figure 8. Average first year production. Total production after the first year of a well's life is generally considered to be a good productivity indicator.

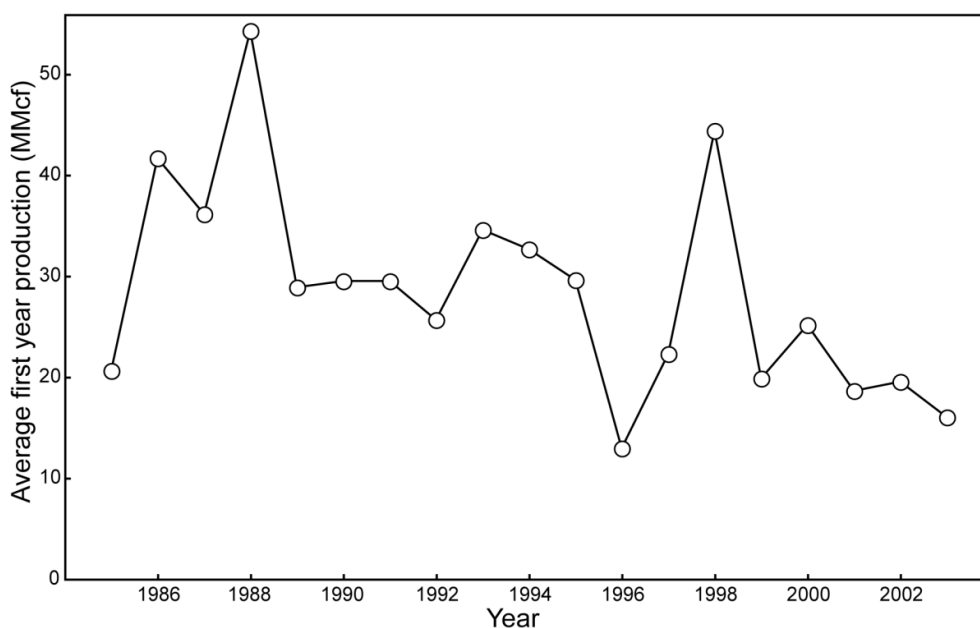

Figure 9. Production groups on the basis of multi-year trends defined by first year production.

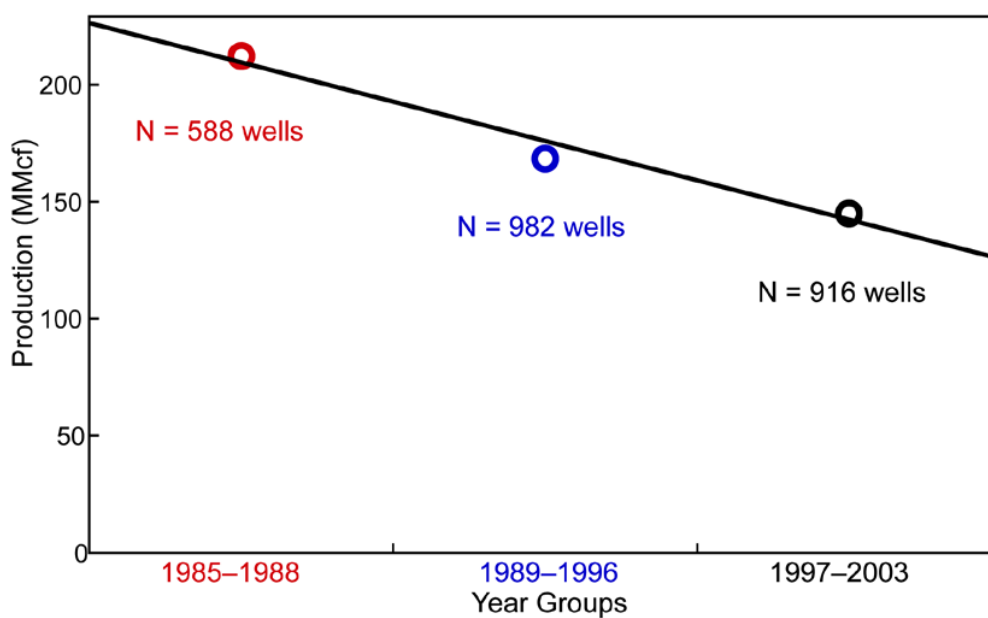

Figure 10. Materials consumed in well construction and drilling time for Indiana County, PA.

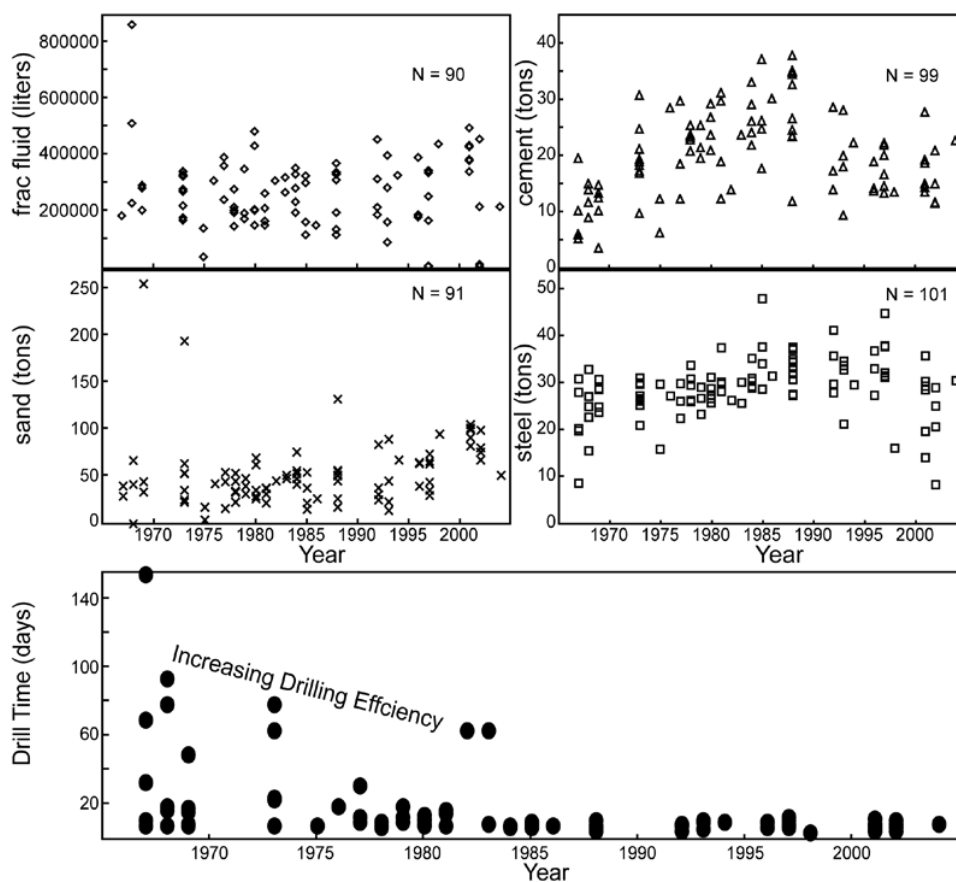

Figure 11. Energy inputs and outputs used to calculate EROI of an average well in the BVE play in Indiana County, Pennsylvania.

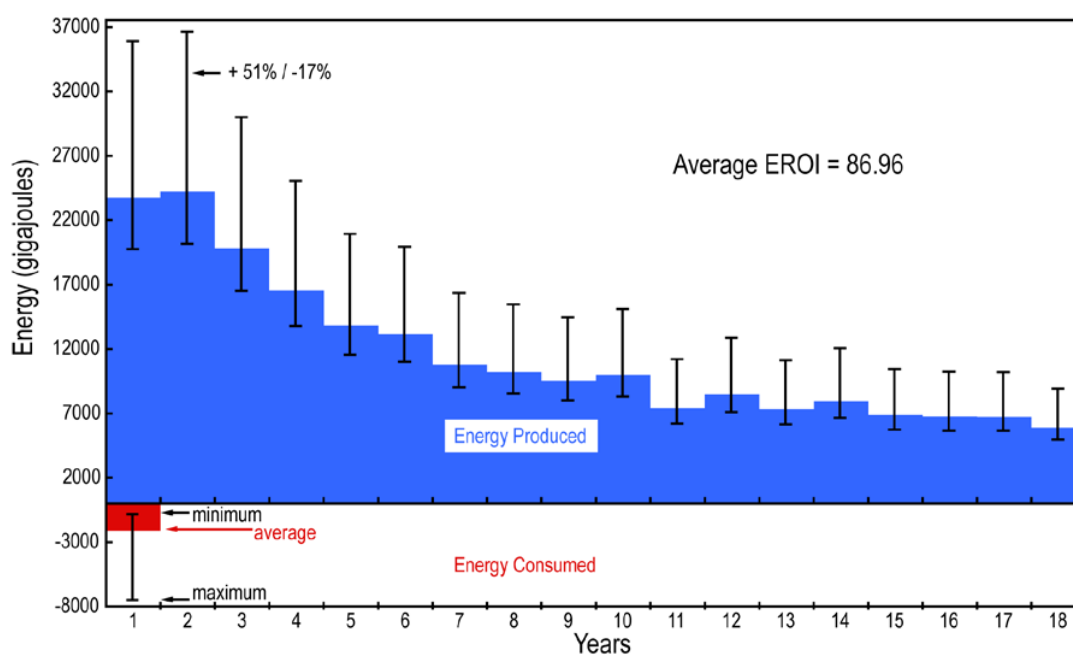
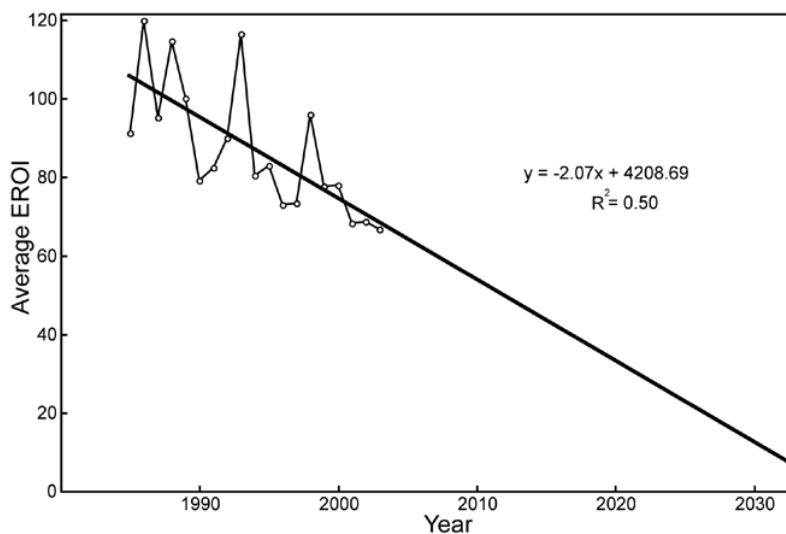
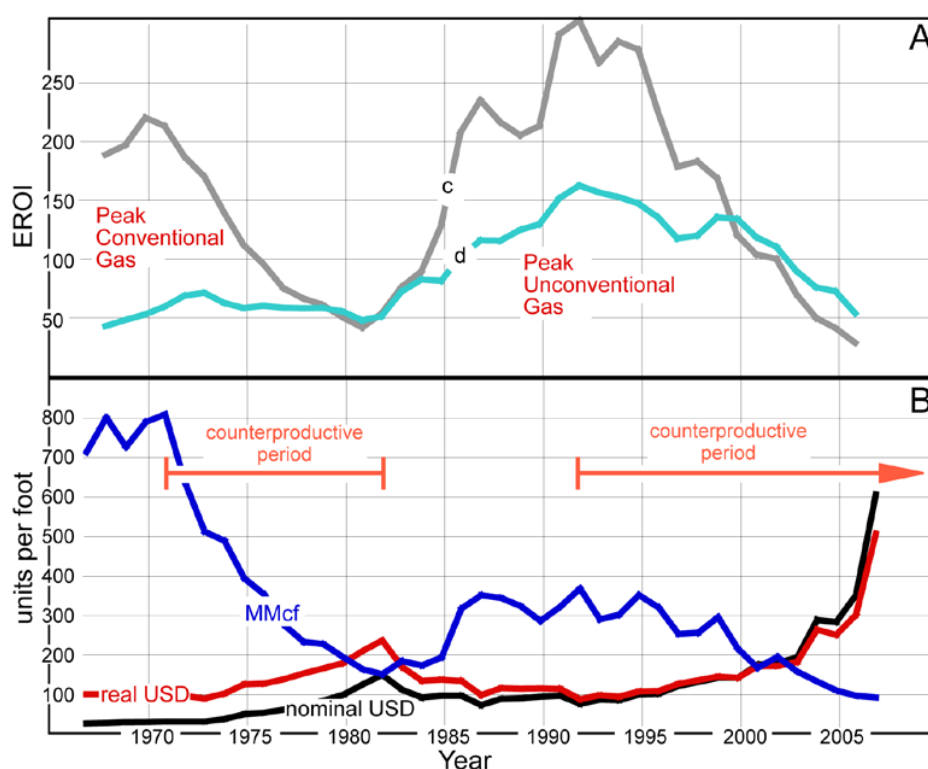

Figure 12. EROI time series and linear prediction for BVE play in Indiana County, Pennsylvania.



On the basis of materials consumed, BVE tight gas wells in Indiana County have an energy cost of 0.59 gigajoules per foot. On the basis of private industry reports and interviews, the same wells in the early 2000s appear to have an approximate U.S. dollar cost of 51 dollars per foot. We used this cost information as a baseline together with well data from the U.S. Energy Information Agency (EIA) to construct an EROI time series for the entire U.S. natural gas drilling system (Figure 13); dollar and energy cost are assumed to be approximately proportional. Drilling cost per foot data from the EIA is corrected for inflation on the basis of 2000 U.S. dollars. The difference between the monetary cost of an Indiana County BVE well and the average gas well in the U.S. is normalized to the year 2000 to create a scaling factor to multiply with the baseline energy cost. The resulting EROI time series can only be calculated back to 1967 because of limited cost data. Scaling the energy cost in this way shows that upstream EROI appears to have peaked twice above 200:1 in the early 1970s and 1990s. Calculating an additional scaling factor for energy cost on the basis of the number of wells drilled annually appears gives a much lower EROI, but shows the same general trends. The total EROI ratio calculated by scaling the energy costs using cost per foot data is multiplied by the scaling factor calculated from the number of wells drilled; this shows a similar trend with values mid way between the other two EROI trends. Between 1992 and the present the EROI for U.S. natural gas appears to have decreased by one order of magnitude and is declining at a steady rate. A comparison of production per foot drilled to cost per foot drilled shows two periods of increasing cost with decreasing production. Each period corresponds with decreasing EROI as well as known historical gas crises.

Figure 13. EROI (A) and productivity for the United States (B). EROI (c) is calculated on the basis of cost differences between our baseline well study and the average cost per well for the United States using footage drilled, and gross withdrawals from gas wells (Equation 3). EROI (d) is calculated as in (c), but the EROI ratio is multiplied by a factor derived from the number of wells drilled in a given year (Equation 4). Each EROI curve is a two-point moving average of the EROI calculated for the years between 1967 and 2007. Counterproductive periods in (B) are defined as years when cost per unit depth increases as production per unit depth decreases over several years. All data are from the EIA [1] except for the well-cost data for our baseline well. Real U.S. dollars are derived from nominal U.S. dollars by correcting for inflation from the year 2000.



4. Discussion

4.1. Production Characteristics

Total natural gas production from Indiana County has been increasing since detailed government records started in 1991 (Figure 4); however, total production values may be misleading. For example, if this production data is compared to the number of wells reporting, the total production per well is decreasing by approximately 0.07 MMcf per year (Figure 5). Peak production in Indiana appears impossible to assess because of the lack of detailed records dating back before 1991. However, total production roughly corresponds with the number of wells drilled because production decreases rapidly over several years. This means that peak gas likely occurred in the late 1980s with a second minor peak in total production occurring in the late 1990s. Sparse information is available, but what does exist seems to suggest that the gas fields in Indiana County are in decline. Another peak in production

may seem possible, but the recent decrease in production per well coupled with the high geographic density of well sites (Figure 2) appears to suggest otherwise.

Other indicators suggest that the BVE play in Indiana County is in decline. These include lifetime production per well (Figure 6), production for the first year (Figure 8), and multi-year trends on expected production (Figure 9). Average production of a typical BVE well in Indiana County was assessed at 180 MMcf for 16 years after a well was drilled in 1996 [19]. However, these numbers are not reliable. The average productivity of wells drilled in 1986 actually came in, after 16 years, higher at 234 MMcf. The earlier, lower estimate is likely due to insufficient data in 1996. The expected average production of BVE wells in Indiana County did not decrease to the previously estimated levels until after 2001. The year-to-year changes in production appear to be subtle (Figure 6) and highly variable (Figure 7). An average logarithmic-scale (decline) production curve shows a good fit to all of the production data for all years and suggests that year-to-year production has not changed much over the past three decades. However, the average production of all wells for all years seems to hide the subtlety of the production changes from year-to-year as evidenced by production per well (Figure 5) and first year production values (Figure 8). Changes in productivity are occurring over several years such that a year-to-year analysis of production does not capture the all of the field production characteristics. First year production values do show three trends. First, average first year production increased during the 1980s. Second, average first year production decreased to approximately 30 MMcf in 1989 with a sharp drop in 1996. Third, first year production picked up again in 1998 and has gradually decreased since. We interpret the peaks in first year production to reflect minor discoveries within the field with subsequent declines. Splitting the production data accordingly into groups indicates an overall production decrease with each well group contributing to an overall decline in production per well with time (Figure 9), *i.e.*, the Indiana County BVE play is in decline.

4.2. Materials Consumed

Materials used in well construction can vary significantly. For example, when examining 101 well records, the amount of casing used in a well varies by 44% at two standard deviations. However, drilling depth varies by only 15% at two standard deviations among well samples such that casing and tubing amounts would be expected to vary by at least this much. The amount of variation in well casing is due to the use of varying casing diameters among different well operators. It is not known by us whether the size of casing and tubing affects production or if the different sizes reflect the well construction programs of different companies. In our estimation, casing and tubing account for 50% of the energy cost. This is in contrast to the typical 10–20% monetary cost of casing and tubing for drilling elsewhere [20,21]. Because casing and tubing account for a large percentage of the energy consumed in well construction and the variation in their use is high, it is necessary to calculate a minimum and maximum energy cost for the wells in Indiana County.

Diesel used for drilling and completion can contribute greater than 90% of the energy cost of drilling a natural gas well in Indiana County. Accurate numbers on amount of fuel used in the construction of these wells was difficult to obtain. What little information we acquired was checked against private industry reports from similar wells drilled elsewhere. Variation in fuel consumption is expected to be significant between wells because of the varying age of engines and equipment and the

time to drill. Time to drill varies between three and 44 days, so fuel consumption would be expected to have a similar variation. At 450 gallons of diesel fuel or 886 GJ per day any inefficiencies and complications in the drilling process such as old equipment, broken bits, and twisted, broken, or stuck drill pipe can add a significant energy cost to well construction.

4.3. EROI

The average well drilled in Indiana County between 1985 and 2003 has an EROI of approximately 87:1 (Figure 11), which is a high energy return compared to other non-fossil fuels, but is consistent with EROI of other high-EROI fossil fuels [29]. EROI suggests that natural gas is competitive with respect to other commercially available sources of energy such as nuclear, wind, solar, and biomass. This makes sense when considering the relatively low price of natural gas and its predominance as an industrial fuel.

The high EROI of these marginal fields suggests that natural gas will continue to be a useful fuel despite decreasing reserves and marginally economic fields. Wells with above average material consumption can still yield a high rate of return (Figure 11). More efficient construction of wells could increase the profit margin of production companies and would likely have the effect of extending the economic life of the entire field. The highly variable material consumption of well construction in Indiana County could be reduced, especially in terms of diesel fuel consumption, drilling rate, and the use of recycled steel in casing and tubing. Production is also highly variable, however, the geologic complexity of the field appears more difficult to predict. New well treatment practices, *i.e.*, hydraulic fracturing, may increase productivity in the BVE tight gas field, but the energy and environmental costs of such new practices are not yet known.

EROI calculations appear to be useful for predicting the future of the BVE tight gas field in Indiana County (Figure 12) and could be modeled on the existing data with constraints from the remaining space that is available to drill. For example, the EROI appears to be declining as drilling area increases which suggests that there may be spatial relationships between production and well density, *i.e.*, field depletion due to infill drilling. This is important new information not only for local government economic planning, but also for the state of Pennsylvania since Indiana County accounts for nearly one quarter of total state gas production between 1985 and 2003. A simple linear model on the basis of the average EROI for each year since 1985 suggests that the field may be economically productive just beyond 2030. This is an oversimplification because the historical data show that field development may find new areas with higher producing wells. Also, increased efficiencies in drilling practices periodically cause the energy returns to fluctuate. However, it is an accurate prediction that BVE natural gas is a finite resource that will continue to dwindle. Technology advances and increased efficiencies will only serve to cause fluctuations in gas production that has an overall downward trajectory. Currently, it appears that technological effects that increase production are receding because average production per well is decreasing.

The EROI calculated here is high compared to previous EROI estimates for natural gas [7,29-32]. However, the EROI range calculated here is a conservative estimate. The “true” values for EROI of a natural gas well should be lower because of several factors. First, there are costs that cannot be accounted for at this time because of insufficient data. Several materials such as sorted sand,

water, acids and gels used in well treatment, drill pipe and bits, equipment repairs, etc., require extraction, manufacturing, and transportation. Second, refining and distribution energy costs that will further decrease EROI are excluded. Energy efficiency information in processing natural gas to remove natural gas liquids and other impurities and the transmission of natural gas to and from the processing plant are not available; however, these are expected to contribute at least a few percent of the total energy cost of marketed natural gas. Third, according to the U.S. Energy Information Administration, the dry holes that are drilled in petroleum exploration and production account for more than 10% of all wells drilled in the United States. This alone should have a significant impact on the large-scale EROI calculations and individual fields with higher failure rates.

Our EROI findings (67:1 to 120:1) are much larger than the (10:1 to 20:1) EROI modeled by Gately [32], which suggests that marginal wells in the Appalachian Basin require much less effort for equal amounts of gas acquired by offshore wells in the Gulf of Mexico. Increased drilling effort in complex production environments requires large volumes of gas compared to the minimal volumes found in some less complex production environments. Low volume and highly complex-drilling environments, such as some shale gas reservoirs could ultimately show relatively low EROI values. As unconventional natural gas fields become increasingly exploited, the energy returned on the energy invested may become a limiting factor in economic development. Since it appears that offshore gas will no longer be a major contributor to the total U.S. natural gas production (offshore rig counts from the EIA [1]), sources like shale gas and imported liquid natural gas should be assessed for comparison.

4.4. EROI for the United States

We assume that the energy cost for drilling a well in the BVE field of Indiana County serves as a baseline energy cost for natural gas drilling in the United States. The average monetary cost per foot for natural gas wells in the U.S. [1] between 2000 and 2005 is three to five times higher than the cost of BVE wells in Indiana County. In 2007, the average cost of a gas well in the U.S. increased to roughly eight times that of a BVE gas well in Indiana County, which is expected on the basis the cost of unconventional gas wells [33,34] that are increasingly dominating U.S. gas development. We can make another assumption that the real dollar cost per foot of a gas well is proportional to the energy cost per foot. The remaining data needed to make an EROI calculation are on record with the U.S. government. Gross withdrawals data from wells specifically drilled for natural gas are only available from 1967 [1], which limits our estimations of energy returned in the past. Costs per foot data are currently available up to the year 2007. Another limitation of the data is that footage drilled for natural gas wells cannot currently be controlled for dry holes so that all footage drilled must be considered together. Dry holes cost less money and therefore our EROI time series calculation likely overestimates energy costs. However, the accurate energy cost would not change the overall EROI trend as it is largely controlled by the differences between production and total footage drilled.

The EROI of natural gas production peaked twice in the U.S. The first peak in 1971 corresponds with Hubbert's [35] predicted peak gas and the actual peak in conventional natural gas production [1]. EROI decreased between 1971 and 1982 because of a decrease in total gross withdrawals, a two-fold increase in real dollar cost per foot, and a four-fold increase in the number of wells drilled. This decline likely reflects the inability of technology to keep pace with declining conventional gas

reservoirs. A corresponding increase in research on unconventional gas resources occurred over this same interval [36]. This research coupled with increases in the price of gas was successful at driving technological efficiency in field development and identifying new resources. EROI climbed rapidly between 1982 and 1987 largely as a result of offshore gas production and then increased to the second peak 1993 because of increased production from unconventional reserves. Marketed production during this time was supplemented by contributions from Canada and a continuing decrease in flaring/venting of natural gas contained in crude oil wells. Gas that would be typically flared or vented represented more than 25% of gross gas withdrawals in the 1940s and decreased to 0.05% by 1982. Also, gross withdrawals from gas wells continued to increase despite fewer wells being drilled. This increased production per well is likely a result of new resources and technology. All available natural gas data for the U.S. suggests that we are currently in a depletion trend. EROI has declined rapidly from 1993 until the present because gross withdrawals from gas wells have decreased with respect to an increased number of wells drilled and rising drilling costs. The current decline in EROI is due to the same factors that contributed to the EROI decline of the 1970s, however the difference is that there does not appear to a new gas resource beyond shale reservoirs. Also, the real monetary cost of drilling has increased by almost twice as much as it did during the conventional gas decline of the 1970s. Unconventional resources are maintaining production [1], but possibly at an increasingly higher energy cost. These drastic changes in drilling cost and production should control the current trend in natural gas EROI for the U.S.

Our analyses of U.S. EIA data suggest that there are at least two counterproductive periods in the history of United States natural gas exploitation. We use the term counterproductive because increased drilling efforts are yielding production results that are opposite of what we might expect—as one works harder there should be a corresponding increase in benefit. The first counterproductive period (Figure 13) should serve as a historical warning of what is to be expected, which occurred over a ten year period after conventional natural gas peaked in the early 1970s and ended when new gas supplies (e.g., Gulf of Mexico) were discovered in the United States. Relatively severe economic disturbances occurred during the bust and boom, *i.e.*, beginning and end, of this counterproductive period. The second counterproductive period began in the early 1990s and has continued for nearly two decades to the present. If the historical precedent of the first counterproductive period was matched (Figure 13), then we should have had a new gas source made available in 2001. This new source did not materialize. There are no more new gas sources beyond shale reservoirs within the United States that are predicted to increase production per well or EROI. Shale gas has been touted as a new and abundant gas source, however the shale gas production has yet to show an impact on production per well. In fact, since the beginning of the current counterproductive period, the real monetary cost per foot of natural gas extraction in the U.S. has increased exponentially to more than six times that of 1993; and production per well has decreased to levels not seen since the beginning of the last century. This seems to suggest that the number of wells drilled annually needs to be continually increased to maintain overall production levels, which has been relatively constant for a few decades. Any economic perturbation similar to that of the first counterproductive period of the 1970s and 1980s could cause domestic gas production to drop at a relatively fast rate with corresponding economic consequences.

5. Conclusions

This research provides the first publicly available analysis of the direct energy requirements, albeit somewhat incomplete, for natural gas well construction. The materials consumed in natural gas production have never before been incorporated into an EROI analysis. As such, the data in this research should provide an empirical check against EROI models based on dollar cost analysis. This research also underscores a dearth of information that is needed to accurately calculate the energy costs of energy production and to make predictions about the future economic viability of gas fields. Such information will be critical for future economic development in this region and larger economic systems.

There are parallels between the BVE play in Indiana County and the total natural gas extraction system of the U.S. Total production for both has increased to a plateau that has remained relatively unchanged for at least a couple of decades. However, first year production and total production per well has been decreasing for quite some time, *i.e.*, increased drilling effort has only maintained production levels. Increases in drilling effort in both the larger and smaller gas systems are showing the same results. EROI for the BVE play in Indiana County and the U.S. are currently both declining at a linear rate, which might reflect similar drilling effort and production characteristics. A cursory examination of the well density in Indiana County suggests that the heavily drilled area is likely approaching a limit controlled by the available drilling space. Since the U.S. production trends are similar to Indiana County it may be possible that the national gas system is also approaching a spatial limit.

Although the EROI for natural gas appears to be anomalously high, it has been suggested that the overall EROI (upstream and downstream) for natural gas may have been much higher than 100:1 in the past [31]. If true, then the EROI calculated here might be approximately correct because we only account for upstream energy costs. This seems to suggest that transmission and processing costs/losses could significantly affect both energy inputs and outputs. Even if transmission and processing costs lower EROI by 50% for any given year, the overall EROI for natural gas will still be appreciably higher than most other alternative fuels.

The EROI analyses presented here suggest that the concept of peak gas as defined by total production is misleading; energy requirements for natural gas extraction have a substantial impact on the total available gas. This is particularly troubling given the recent industry sponsored reports that are directed at convincing policy makers that there is abundant gas for the next several decades, even up to 100 years [5,36-38]. The conclusion of these reports is that more natural gas infrastructure is needed to improve economic stability and decrease our carbon output in the face of global warming. However, these pro-natural gas reports fail to account for the energy requirements and related changes in production characteristics. For example, imported liquid natural gas supplies come from other geologic locations with similar decline characteristics. This only avoids the inevitable supply depletion and at an added transportation cost. New shale gas reservoirs (*i.e.*, unconventional gas) appear to have tremendous gas supply potential, however the depletion rate of individual wells and entire fields are much faster than conventional gas fields [39]. This means that shale gas may only provide a short-term extension to the total U.S. gas supply with an accelerated rate of depletion. Barnett Shale gas wells, which are at the heart of the much touted success story in natural gas development, currently reach the

same production levels in a few years that the tight gas wells in the BVE play do in 16 years. As shale gas wells increasingly become dominant the overall decline rate of domestic production will accelerate, *i.e.*, the summed depletion rate of individual gas wells must equal the overall depletion rate. Replacing slowly depleting wells with others that deplete faster, means that the total gas system will not deplete slowly over the next century. The large volumes of gas promised from shale reservoirs will likely maintain U.S. production at a reliable but modest level; however catastrophic drops in gas supply can be expected if shale gas is relied upon as a replacement of conventional gas. The implications of this analysis will likely hold true for crude oil, as it is a well-derived and finite resource with similar decline characteristics.

Acknowledgements

We thank Jon Freise, Carey King, and Arthur Berman for useful information, helpful discussion, and fruitful advice.

References and Notes

1. United States Department of Energy, Energy Information Agency. *Natural gas data*: <http://www.eia.gov/naturalgas/data.cfm> (accessed on 20 October 2011).
2. United States Department of Energy, Energy Information Agency. *Energy Use in Manufacturing—1998 to 2002*. Available on: <http://www.eia.gov/> (accessed on 20 October 2011).
3. Lee, W. US lessons for energy industry restructuring: Based on natural gas and California electricity incidences. *Energ. Policy* **2004**, *32*, 237-259.
4. Bentley, R.W. Global oil & gas depletion: An overview. *Energ. Policy* **2002**, *30*, 189-205.
5. The International Energy Agency *World Energy Outlook 2009*; OECD Publishing, Paris, France, 2009.
6. Hall, C.; Lindenberger, D.; Kümmel, R.; Kroeger, T.; Eichhorn, W. The need to reintegrate the natural sciences with economics. *BioScience* **2001**, *51*, 663-673.
7. Gagnon, N.; Hall, C.; Brinker, L. A preliminary investigation of energy return on energy investment for global oil and gas production. *Energies* **2009**, *3*, 490-503.
8. Almeda, P.; Silva, P.D. The peak of oil production—Timings and market recognition. *Energ. Policy* **2009**, *37*, 1267-1276.
9. Cheney, E.S.; Hawkes, M.W. The future of hydrocarbons: Hubbert's peak or a plateau? *GSA Today* **2007**, *17*, 69-70.
10. Reynolds, D.B.; Kolodziej, M. North American natural gas supply forecast: The Hubbert method including the effects of institutions. *Energies* **2009**, *2*, 269-306.
11. Deffeyes, K.S. *Hubbert's Peak: The Impending World Oil Shortage*; Princeton University Press: Princeton, NJ, USA, 2001.
12. Höök, M.; Söderbergh, B.; Jakobsson, K.; Aleklett, K. The evolution of giant oil field production behaviour. *Nat. Resour. Res.* **2009**, *1*, 39-56.
13. Höök, M.; Aleklett, K. A decline rate study of Norwegian oil production. *Energ. Policy* **2008**, *36*, 4262-4271.

14. Höök, M.; Hirsch, R.; Alekett, K. Giant oil field decline rates and their influence on world oil production. *Energ. Policy* **2009**, *37*, 2262-2272.
15. Söderbergh, B. Production from Giant gas fields in Norway and Russia and subsequent implications for European energy security. In *Digital Comprehensive Summaries of Uppsala Dissertations from the Faculty of Science and Technology* 705, 2010.
16. Interstate Oil and Gas Compact Commission (IOGCC) *Marginal Wells: Fuel for Economic Growth*; Oklahoma City, OK, USA, 2008.
17. Boswell, R.; Thomas, B.; Hussing, R.; Murin, T.; Donaldson, A. Upper Devonian Bradford sandstones and siltstones. In *The Atlas of Major Appalachian Gas Plays*; Roen, J., Walker, B., Eds.; West Virginia Geological and Economic Survey: Harrisburg, PA, USA, 1996; pp. 70-76.
18. Gross production data downloaded from the Pennsylvania Department of Conservation and Natural Resources. www.dcnr.state.pa.us/ (assessed on 12 October 2011) – Note: Production data for individual wells was acquired during several visits to the main offices of the Pennsylvania Department of Conservation and Natural Resources in Pittsburgh and Harrisburg, Pennsylvania.
19. Harper, J.; Tatlock, D.; Wolfe, R. Petroleum—Shallow oil and natural gas fields of Pennsylvania. In *The Geology of Pennsylvania*, Shultz, C., Ed.; Pennsylvania Bureau of Topographic and Geologic Survey: Harrisburg, PA, USA, 1999, Chapter 38-A, Fourth Series, Special Paper No. 1, pp. 485-505.
20. Kaiser, M. A survey of drilling cost and complexity estimation models. *Int. J. Petrol. Sci. Technol.* **2007**, *1*, 1-22.
21. Petroleum Services Association of Canada *Well Costs Study*. N.L. Fisher Supervision & Engineering Ltd.: Calgary, Canada, 2005.
22. Stubbles, J.R. *Energy Use in the U.S. Steel Industry Historical Perspective and Future Opportunities*. Energetics, Inc.: Columbia, MD, USA, 2000.
23. Worrell, E.; Price, L.; Martin, N. Energy efficiency and carbon dioxide emissions reduction opportunities in the US iron and steel sector. *Energy* **2001**, *26*, 513-536.
24. Margolis, N.; Sousa, L. *Energy and Environmental Profile of the U.S. Iron and Steel Industry*, DOE/EE-0229; Energetics, Inc.: Columbia, MD, USA, 2000.
25. Pellegrino, J.; Margolis, N.; Justiniano, M.; Miller, M.; Thedki, A. *Energy Use, Loss, and Opportunities Analysis for U.S. Manufacturing and Mining*. Energetics, Inc. and Energy-Economics Environment Modeling Laboratory: Columbia and North Potomac, MD, USA, 2004.
26. Worrell, E.; Galitsky, C. *Energy Efficiency Improvement and Cost Saving Opportunities for Cement Making, An Energy Star Guide for Energy and Plant Managers*; Energy Analysis Department, Environmental Energy Technologies Division, Ernest Orlando Lawrence Berkeley National Laboratory: Berkeley, CA, USA, 2004.
27. United States Department of Energy, Energy Information Agency *Annual Energy Review*, DOE/EIA-0384; 2008.
28. Yanoski, M., CEO of Target Energy, Inc., Indiana, PA, USA. Personal interview regarding Authorization for Expenditure reports, 2009.
29. Hall, C.; Balogh, S.; Murphy, J. What is the minimum EROI that a sustainable society must have? *Energies* **2009**, *2*, 25-47.

30. Cleveland, C.; Costanza, R.; Hall, C.; Kaufmann, R. Energy and the U.S. economy: A biophysical perspective. *Science* **1984**, *225*, 890-897.
31. Cleveland, C. Net energy from the extraction of oil and gas in the United States. *Energy* **2005**, *30*, 769-782.
32. Gately, M. The EROI of U.S. offshore energy extraction: A net energy analysis of the Gulf of Mexico. *Ecol. Econ.* **2007**, *63*, 355-364.
33. Hayden, J.; Pursell, D. *The Barnett Shale Visitors Guide to the Hottest Gas Play in the U.S.* Pickering Energy Partners, Inc., Institutional Research: Houston, TX, USA, 2005.
34. Engelder, T. Marcellus 2008: Report card on the breakout year for gas production in the Appalachian Basin. *Fort Worth Basin Oil Gas Mag.* **2009**, *August*, 19-22.
35. Hubbert, M.K. Nuclear energy and the fossil fuels: Drilling and production practice, *Proc. Am. Petrol. Inst. Spring Meet.* **1956**, *March*, 7-25.
36. *U.S. Natural Gas Availability: Gas Supply Through the Year 2000*, OTA-E-245; Congress, Office of Technology Assessment: Washington, DC, USA, February 1985.
37. United States Department of Energy, Energy Information Agency *Annual Energy Outlook*, DOE/EIA-0383, 2010.
38. *The Future of Natural Gas: An MIT Interdisciplinary Study—Interim Report*, by the MIT Energy Initiative. Massachusetts Institute of Technology: Cambridge, MA, USA, 2010.
39. Berman, A. Shale Plays, Risk Analysis, and Other Perils of Conventional Thinking. *Houston Geol. Soc. Bull.* **2009**, *March*, 27-35.

© 2011 by the authors; licensee MDPI, Basel, Switzerland. This article is an open access article distributed under the terms and conditions of the Creative Commons Attribution license (<http://creativecommons.org/licenses/by/3.0/>).

Article

Ultra-Deepwater Gulf of Mexico Oil and Gas: Energy Return on Financial Investment and a Preliminary Assessment of Energy Return on Energy Investment

Matthew Moerschbaeche^{1,2,*} and John W. Day Jr.¹

¹ Department of Oceanography and Coastal Sciences, Louisiana State University, 2237 Energy, Coast, and Environment Building, Baton Rouge, LA 70803, USA; E-Mail: johnday@lsu.edu

² Department of Renewable Natural Resources, Louisiana State University, 2231 Energy, Coast and Environment Building, Baton Rouge, LA 70803, USA

* Author to whom correspondence should be addressed; E-Mail: mmoers1@lsu.edu; Tel.: +1-225-578-6508; Fax: +1-225-578-6326.

Received: 9 July 2011; in revised form: 3 August 2011 / Accepted: 5 August 2011 /

Published: 21 October 2011

Abstract: The purpose of this paper is to calculate the energy return on financial investment (EROFI) of oil and gas production in the ultra-deepwater Gulf of Mexico (GoM) in 2009 and for the estimated oil reserves of the Macondo Prospect (Mississippi Canyon Block 252). We also calculated a preliminary Energy Return on Investment (EROI) based on published energy intensity ratios including a sensitivity analysis using a range of energy intensity ratios (7 MJ/\$, 12 MJ/\$, and 18 MJ/\$). The EROFI for ultra-deepwater oil and gas at the well-head, ranged from 0.019 to 0.022 barrels (BOE), or roughly 0.85 gallons, per dollar. Our estimates of EROI for 2009 ultra-deepwater oil and natural gas at the well-head ranged from 7–22:1. The independently-derived EROFI of the Macondo Prospect oil reserves ranged from 0.012 to 0.0071 barrels per dollar (*i.e.*, \$84 to \$140 to produce a barrel) and EROI ranged from 4–16:1, related to the energy intensity ratio used to quantify costs. We believe that the lower end of these EROI ranges (*i.e.*, 4 to 7:1) is more accurate since these values were derived using energy intensities averaged across the entire domestic oil and gas industry. Time series of the financial and preliminary EROI estimates found in this study suggest that the extraction costs of ultra-deepwater energy reserves in the GoM come at increasing energetic and economic cost to society.

Keywords: Gulf of Mexico; net energy; Deepwater Horizon; Macondo; oil spill

1. Introduction

Since the early 1970s, rates of domestic oil production in the U.S. have decreased, and domestic demand has been met increasingly by oil imports. Domestic oil is becoming scarcer and more difficult to produce due to reservoir depletion and a sharp decrease in the number of large, easily accessible discoveries onshore or in shallow coastal environments [1-3]. Consequently deepwater and ultra-deepwater Gulf of Mexico (GoM) oil has become increasingly important to U.S. domestic oil production over the last 20 years [4]. Not surprisingly energy extraction in the ultra-deepwater environment requires more financial and energy resources than from onshore or in shallow-water environments. Drilling costs increase exponentially with depth in the ultra-deepwater environment [5]. The increase in energy and financial costs results in decreased net energy available to society. The recent era of deepwater drilling is often associated with the notion of national energy independence and has been touted as a potential solution to decrease dependency on imports. However, proven oil reserves in the federal waters of the GoM (approximately 3.5 billion barrels at year-end 2008) are inadequate to support national domestic oil consumption for even one year [6,7].

Production of deep and ultra-deepwater reserves has become profitable in part due to the establishment of government subsidies and the increase in oil prices over the last decade [7-9]. Gately (2007) reported without explicit quantification that the energy return on investment (EROI) for deepwater and ultra-deepwater oil is low, decreases with an increase in water depth and is less than 10:1 [10]. Gately *et al.* [10] estimated EROI for deepwater (depths of 900 m +) GoM using production data from the Minerals Management Service (MMS, now Bureau of Ocean Energy Management, Regulation and Enforcement) combined with previously published operational dollar cost estimates [11] and energy intensity factors which allow for the conversion from dollars to energy units [12]. EROI including only direct costs at 900m+ water depths ranged from 10–27:1 for the years 2000–2004 and 3–9:1 for the same years when including indirect costs of production [10]. The energy intensity factors used in past studies may be inaccurate due to changes in technology, advances in energy efficiency, and the scale of offshore operations since they were first proposed [12,13]. Unfortunately it is impossible to verify the accuracy of Gately's study [10] or to recreate either analysis since no data were given.

The purpose of this paper is to calculate explicitly the Energy Return on Financial Investment (EROFI) [14] of oil and gas production in the ultra-deepwater Gulf of Mexico (GoM) for 2009 and the EROFI of oil in the Macondo Prospect. We also derived preliminary EROI estimates based on a range of energy intensity ratios [14,15].

The EROFI is an estimate of the financial cost for the production of a barrel of oil or natural gas expressed as barrel of oil equivalent (BOE). EROFI is the amount of money expended by an energy producing entity divided by the amount of energy produced. An energy producing entity must produce energy at sufficient economic profit while paying off the costs of the full supply chain of labor, materials, and transport in order to maintain a profitable business [14]. Profitability is, however, related directly to the supply chain costs. The entity fails to be financially profitable when the incurred

costs are greater than the price of the product being sold. EROFI analysis provides insight into the base price for which a barrel of oil must be sold in order to maintain economic profitability. EROI analysis is a tool used to measure the net energy of an energy supply process [16]. The net energy of an energy source is the amount of energy returned to society divided by the energy required to get that energy [17]. An energy source becomes an energy sink when the amount of energy used in extraction is greater than the extracted amount of energy (EROI < 1:1). In 1930, the average domestic oil discovery yielded at least 100 units of energy equivalent output production for every unit of input, and that oil could be produced at a return of about 30 for one. [15,18]. Today, the average net energy measured by EROI of domestic oil production has declined to about 10:1, or 10 units of output for every unit of input [15,18].

The importance of EROI to a society is that the analysis provides a measure of the surplus energy gained from an energy source that can be diverted to other sectors of the economy to produce goods and services other than those required for energy extraction. Decreasing EROI increases the proportion of economic output that goes into the energy extraction sector of the economy leaving fewer economic and energy resources available for non-energy extraction sectors. Net energy, and the associated surplus energy to society, declines with declining EROI. The trend towards low EROI fuels affects the quantity and affordability of the fuel supply [3].

This paper presents a detailed although non-comprehensive analysis of the EROFI for ultra-deepwater oil and gas in the GoM in 2009 and potential Macondo Prospect reserves using updated financial data. In particular data that have become available in the wake of the Deepwater Horizon oil rig disaster are used to increase understanding of the EROFI for energy production in the federally regulated ultra-deepwater outer continental shelf of the GoM. Because of a lack of access to accurate, comprehensive ultra-deepwater energy input production data and a degradation of federal energy use statistics, it is necessary to use financial data and convert this to energy inputs using energy intensity ratios in order to estimate the energy return on energy investment in the ultra-deepwater GoM in 2009.

1.1. GoM Oil Production

GoM federal offshore oil production accounted for approximately 29% of total U.S. oil production in 2009. Deepwater and ultra-deepwater GoM areas contributed to 80% of total federal offshore GoM oil in 2009 [19]. Deepwater (1,000–5,000 ft.) oil production in the GoM became a major part of U.S. domestic energy production in 1998 when shallow water production began to decline. Deepwater production peaked in 2004 and has been in decline ever since. Ultra-deepwater (>5,000 ft.) production has helped to offset the deepwater production decline in a similar manner as deepwater production had previously offset shallow-water production in the late 1990s (Figure 1).

Figure 1. Oil production in the Gulf of Mexico (GoM) Federal Offshore region including lease condensate Source: Minerals Management Service (MMS), Energy Information Administration, Office of Oil and Gas (2010). (mmbbls equals million barrels per year).

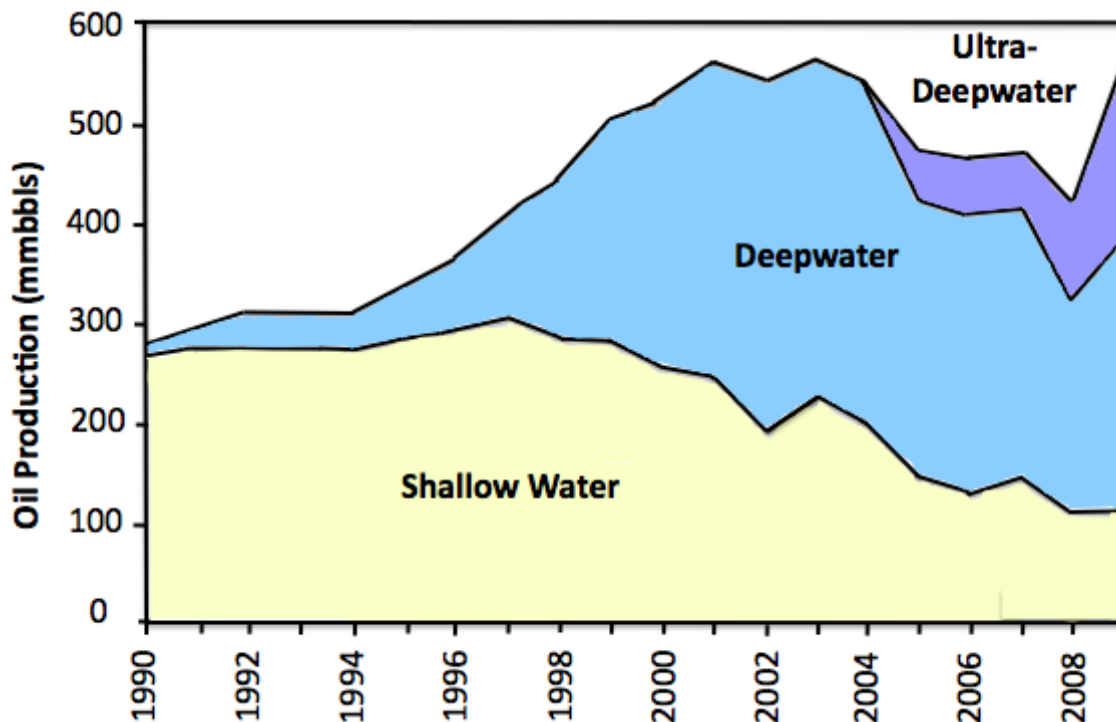

Federal offshore production, formerly declining, increased by 33% (over 147 million barrels) between 2008 and 2009 [7,20]. The increase in production for 2009, however, reflects not only production from the new projects that came online, but also the addition of volumes that were shut-in during 2008 as a result of hurricane activity [9]. For oil, 75-percent of the increase in production in 2009 is a reflection of shut-in volumes coming back online [9]. Approximately one third of federal Outer Continental Shelf (OCS) oil production and one quarter of natural gas production in 2009 came from ultra-deepwater (depths >5000 ft).

The production from shallow waters is projected to continue to decline into the future [4]. Shallow water discoveries have declined from approximately 44 discoveries in 2005 to four discoveries in 2009 [21]. Deepwater and ultra-deepwater production is important for offsetting the loss of production from onshore and shallow water in order to maintain the domestic oil industry in the Gulf Coast region. Operating offshore in ultra-deepwater is more complex and more capital-intensive than operating in onshore environments where fixed costs are smaller and production profiles tend to decline at more predictable rates [4], which suggests that EROI there should be lower than for onshore oil. In addition, the largest remaining oil reserves in the GoM exist in the deepwater and ultra-deepwater environments [9] and thus we would expect that EROI would be lower than for onshore production.

The economic profitability of deep and ultra-deepwater production is dependent upon the price of oil and costs associated with exploration, production, transportation, processing, and delivery to end use as well as government subsidies. Past studies [22] concluded that a discovery containing at least

Sustainability 2011, 3

about 1 billion barrels recoverable is required to support an ensuing development project for ultra-deepwater oil, which may cost upwards of \$1 to \$2 billion dollars in up-front Capital Expenditures (CAPEX, 22). Larger reservoirs generally yield higher production rates per well, thereby increasing net energy and financial profitability because less energy and money is required to extract oil from a larger reservoir (*i.e.*, [14]).

1.2. GoM Rig Counts

The number of oil drilling rigs in Federal OCS waters affects the energy return on financial and energy investment. Increasing drilling effort does not always lead to an increase in production [17]. An increase in the number of rigs increases the financial costs of energy extraction, as more energy, labor, and raw materials are required per unit of energy produced. So long as rigs are adding proportional supply to the total energy produced, they are able to offset the increased financial and energy costs of ultra-deepwater projects. The technological advancement in rig design over the last 20 years has allowed for floating rigs including spars, semi-submersibles, and tension leg platforms to tap into multiple wells often miles apart in order to exploit reserves more efficiently, thereby decreasing financial and energy costs [23]. A few dozen rigs were responsible for 72% of the ultra-deepwater oil production in the GoM in 2007 compared to the five thousand or so rigs in shallow water [4]. The percentage of production attributed to smaller rigs is expected to continue to decline into the future [9].

The lifespan of a rig affects the amortized cost of the rig. Rigs have a lifespan of about ten years before a major work over is required [24,25]. Most ultra-deepwater drilling rigs were constructed within the last twenty years, as was the nine year-old Deepwater Horizon. The long-term leasing contract process allows rig construction costs to be recouped over a period of years and insures rig utilization. Rigs are mobile and often produce oil from several different fields over the course of their operational lifetime.

Daily operating costs for deepwater rigs have doubled over the course of the last decade partly as a result of increasing energy costs required by production operations for larger floating rigs often located 100+ miles from shore. At the same time, deepwater and ultra-deepwater drilling operations have become profitable in the age of oil at \$50+/barrel and government subsidies [21,26]. Global investment trends provide evidence for continued deepwater production and decreased shallow and mid-water production [27].

1.3. Macondo Prospect Reserves and Cost Estimates

The Macondo Prospect is an oil and gas reservoir located in Mississippi Canyon Block 252 in the northern GoM just southeast of the mouth of the Mississippi River. The reservoir is in water depths greater than 4,900 ft. (1,700 m) and located more than 17,700 ft. beneath the ocean floor. BP officials estimated that there were approximately 50–100 million barrels of oil associated with the Macondo Prospect [28,29]. Oil companies do not usually extract 100% of the oil in a field [29]. We estimated that the reservoir would yield about 30% of the total reserves or between 15 million and 50 million barrels prior to the blow out.

The Deepwater Horizon rig was valued at \$560 million when delivered to Transocean Ltd. in February 2001 and collapsed into the GoM in April 2010 during deployment at the Macondo

Prospect [30]. Deepwater Horizon was a fifth generation semi-submersible offshore drilling rig that required approximately three years to construct. The average construction cost of floater rigs in operation in 2009 was \$565 million dollars per rig [31]. At the time of its demise, the Deepwater Horizon was leased for three years at a total cost of \$544 million which equates to a bare rig daily lease rate of \$496,800/day. The average daily operations cost for U.S. GoM semi-submersible rigs, including crew, gear, and vessel support operations for 2009 was approximately the same as the daily lease rate [32]. Thus, total daily operational cost was \$993,600. This estimate is consistent with industry-wide costs for similar deepwater oil rigs [33,34].

1.4. Energy Intensity Ratios

The energy intensity ratio is the amount of energy required to produce \$1 of GDP (or of some component of GDP) in a given year. The energy intensity ratio allows for the conversion from financial costs to energy costs in this and other studies. The energy intensity of production is correlated to effort, one variable of which is the number of rigs employed in production [35]. Other variables affecting energy intensity include the size and energy requirements of rigs and support vessels as well as the depth of resource deposits and distance offshore. Energy intensity ratios can be used to estimate approximate costs for many fuels where economic but not energy data are available [14,17,36], which was the case for our study. Usually it is applied only to indirect investments for situations where direct energy is known, such as for other studies in this volume. Energy intensity ratios, for the economy as a whole and for individual industrial sectors, change due to inflation, as a result of material availability, and through efficiency gains. The mean energy intensity ratio for the U.S. economy in 2005 was approximately 8.3 Megajoules (MJ) per \$1 USD. The oil and gas industry is an energy intensive sector with an estimated energy intensity ratio of 20 MJ per \$1 USD in 2005, while heavy construction during the same period was estimated to be 14 MJ per \$1 USD [17]. Advances in energy efficiency and the steady decline in energy intensity ratios over time provide the rationale for estimates used in this study [37]. Previous research has shown that energy intensity ratios serve as an effective proxy in determining the EROI of various energy sources [38]. Energy intensity ratios, however, are not the singular, or best, method for determining EROI. Ideally, energy inputs would be measured directly for each step in the production process. This is often proprietary data not made available to the public or unaccounted for and therefore unavailable. Because of data limitations on energy inputs for ultra-deepwater production, the use of financial investment data used in conjunction with energy intensity ratios allows for a first approximation of EROI in analyzing an extremely important issue given the limited data availability and accessibility and the failure of earlier EROI studies to provide explicit data [14].

The objectives of this study were threefold: (1) To derive estimates of the energy return on financial investment for oil and oil + natural gas in the ultra-deepwater GoM in 2009 based on production and financial cost data; (2) To derive estimates of the energy return on financial investment for oil and oil+natural gas in the ultra-deepwater GoM in 2009 based on the same data plus estimates of energy intensities; and (3) To derive an estimate of the energy return on both financial and energy investment for the estimated total oil reserves of the Macondo Prospect based on industry stated estimates of reserves and financial cost data.

2. Methods

The methodology employed in this paper is based on the second order comprehensive EROI (EROI_{std}) protocol described by Murphy and Hall [36] and previously by Mulder and Hagens [39]. We calculated energy return on financial investment based on King and Hall [14]. The EROFI for potential reserves in the Macondo Prospect was estimated based on annual costs multiplied by the number of years it would take to extract the reserves and divided. The EROFI for total energy produced in the ultra-deepwater GoM in 2009 was determined by dividing the by the reserve volume divided by the total financial costs per operational year. EROI estimates were then estimated using energy intensity ratios established for 2005 combined with production cost data adjusted for inflation. Financial input data includes rig construction and operation costs along with exploration costs. Energy output is based on Macondo oil reserve estimates and 2009 GoM ultra-deepwater oil and natural gas production.

The Macondo Prospect is an average ultra-deepwater well with respect to depth and location [40]. Since all GoM well reserves differ in size and productive capacity, we use the Macondo Prospect field as a proxy for similar sized ultra-deepwater GoM reserves. The period of time required to extract the Macondo reserves is important to the analysis. Increased extraction efficiency decreases operating and production costs that positively impact EROFI. A constant flow rate production profile would result in a higher energy return because of a shorter time for total production. However, virtually all producing wells follow a bell-shaped production profile based on the three phases of ramp-up, plateau, and decline [4]. We calculated EROFI and EROI values for constant and bell-shaped production profiles to demonstrate this difference. The bell-shaped profiles were generated using the MMS full potential scenario forecast methods based on past deepwater GoM production wells [41-42] as follows.

For total recoverable reserves of 50 million barrels in the Macondo Prospect and 30% extraction efficiency, 15 million barrels of oil would be pumped in 600 days if a constant flow rate of 25,000 bpd is assumed. If all of the 50 million barrels were recoverable at the same constant flow rate, it would take 2000 days. Peak production is based on the estimated ultimately recoverable reserves using the MMS full potential scenario forecast equation:

$$\text{Peak Rate} = (0.00027455) \times (\text{ultimate recoverable reserves}) + 9000$$

where the peak rate is in barrels of oil equivalent (BOE) per day and the ultimate recoverable reserves are in BOE [41,42].

The parameters in this equation were derived by plotting maximum production rates of known fields against the ultimate recoverable reserves of those fields, and performing a linear regression between reserves and production [41,42]. These reserve estimates are on a field-by-field basis, so MMS assumed that this relation, based on historic field trends, could be applied on a project basis [41,42]. This equation is generally applied to reserves of 200 million barrels of oil equivalents and more and assuming peak production lasts for four years. For our analysis, we assumed peak flow rates lasted two years since Macondo reserve estimates were one half to one quarter of 200 million barrels and then declined at 12%/year [9]. During the first year of operation, production was set at half its peak rate [9,41,42].

Energy output for the entire GOM study was (BOE) produced in the ultra-deepwater GoM in 2009 [19]. One BOE is equal to 5,800 cubic feet of natural gas. Ultra-deepwater GoM production in 2009, was 182 million barrels of oil and 572 billion cubic feet of natural gas [9]; equivalent to a oil+natural gas total of 291 million BOE. Production costs were based on published rig counts and rig construction costs (Table 1) [31,43]. At any given time there were 25–30 rigs producing in ultra-deepwater [43]. Amortized rig construction costs are based on the number of years it takes to drill a well and extract the resource.

Table 1. Estimated 2009 production costs for the Macondo Prospect and ultra-deepwater GoM rigs.

Study	# of Rigs	Amortized Construction Cost	Operating Cost	Exploration Cost	Total Cost per Year
Macondo Prospect	1	\$62.2 million per year for nine years	\$1 million per day	\$1 million per day for 100 days	\$527.2 million
Ultra-Deepwater GoM	25–30	\$56.5 million per year for 10 years	\$1 million per day	\$1 million per day for 100 days	\$13–15.7 billion

Exploratory costs are operational costs associated with finding and accessing a well prior to production. Technological advancement has led to a decrease in the amount of time required to drill a well. The first wells drilled in the GOM and Brazil took 180–240 days on average [43]. Now these wells are being drilled in 90–120 days [43] so we used 100 days at \$1 million dollars per day based on average production costs.

We used published energy intensity ratios to derive the EROI values from the EROFI. The energy intensities are rough estimates of the energy used to undertake any economic activity derived from the national mean ratio of GDP to energy [17]. These ratios can be used to estimate rough costs for many fuels where economic but not energy data are available [44] and are based on non-quality corrected thermal equivalents [18]. The EROI calculation is limited by available data and is an estimate at the wellhead and not at the point of end use. Estimates of the energy intensity ratio of U.S. oil and gas extraction averaged across all domestic fields and well depths was 9.87 MJ/\$ in 1997, 14.5 MJ/\$ in 2002, and 20 MJ/\$ in 2005 [17,45]. This increase was not due to the energy intensity per dollar increasing, but because more of the downstream energy requirements were included in the higher energy intensity values. Based on these reports, we used energy intensity ratios of 7, 12, and 18 MJ to carry out a sensitivity analysis of the impact of different energy intensity ratios on EROI.

Energy output was based on 1 barrel of oil = 6.11 Gigajoules. EROFI costs are in 2009 USD\$. EROI is based on 2009 USD\$ costs, corrected for inflation using a factor of 1.10 [46], and presented in 2005 USD\$ in order to maintain consistency with the energy intensity ratios used in the analysis. Total energy inputs are the summation of 10-year amortized rig construction costs, 100-day exploration costs per rig, and operational costs converted to energy units using the three different energy intensity ratios. Construction, operational, and exploration costs were summed and were then converted to energy units using the three energy intensity ratios described above. A number of costs were not included because data were not available. These included rig and operator insurance costs, costs associated

with enhanced recovery techniques and costs associated with dry holes. However, these costs are substantial [47].

3. Results

The financial cost per barrel of ultra-deepwater oil in the GoM at the well-head ranged from \$71/barrel to \$86/barrel based on the number of rigs deployed in production. The EROFI for oil + natural gas at the well-head in the GoM in 2009 ranged from 0.019 to 0.022 barrels (BOE), or roughly 0.85 gallons, per dollar, based on the number of rigs deployed in production.

The financial cost at the well-head per barrel of oil available in the Macondo Prospect based on the constant flow rate production profile, was \$62/barrel assuming 15 million barrels produced per day, or \$45/barrel if producing 50 million barrels over 2000 days. The EROFI at the well-head was \$141/barrel of oil in the Macondo Prospect if 15 million barrels were produced over 4 years, or \$84/barrel if producing 50 million barrels over 8 years is.

The preliminary EROI based on financial costs and subsequent sensitivity analysis using three different energy intensity ratios, ranged from 4:1 to 14:1 for 2009 total GoM ultra deepwater oil production while the EROI for total oil plus natural gas production in the ultra-deepwater GoM in 2009 was slightly higher at 7:1–22:1. The EROI for the Macondo Prospect using the MMS full potential scenario forecast varied from 4:1 to 16:1. The EROI of the constant flow rate scenarios for producing 15 and 50 million barrels in the Macondo Prospect at 25,000 bpd are given in Table 2.

Table 2. Calculated EROFI and EROI of Macondo Prospect oil reserves, as reported by BP [28], assuming a constant production rate of 25,000 bpd. The EROI is calculated using three different energy intensity ratios (7MJ/\$, 12MJ/\$, 18MJ/\$) and two different reserve estimates. MJ/\$ = Megajoules/U.S. dollar. All values are inflation adjusted. Since production rates are not constant, it takes longer to produce the oil and EROI will lower as shown in Table 3.

Time (days)	Total Reserves (millions of barrels)	EROFI (2009 USD\$/bbl)	Energy Intensity Ratio (MJ/\$)	EROI
600	15	\$62	7	18:1
			12	10:1
			18	7:1
2000	50	\$59	7	20:1
			12	12:1
			18	8:1

Table 3. Estimated EROFI and EROI of potential Macondo Prospect oil reserves using three different energy intensity ratios (7MJ/\$, 12MJ/\$, 18MJ/\$), two different reserve scenario estimates, and a flow rate based on the MMS full potential scenario forecast equation (MMS 2009). MJ/\$ = Megajoules/U.S. dollar. All values are inflation adjusted.

Time (years)	Total Reserves (millions of barrels)	EROFI (2009 USD \$/bbl)	Energy Intensity Ratio (MJ/\$)	EROI
4	15	\$141	7	9:1
			12	6:1
			18	4:1
8	50	\$84	7	16:1
			12	9:1
			18	6:1

Applying the MMS full potential scenario forecast equation to Macondo field reserves yielded a peak rate of 13,118 barrels/day for 15 million barrels and 22,728 barrels/day for 50 million barrels. If 15 million barrels is recovered, the well would be completely depleted within four years and if 50 million barrels is recovered, the well would be depleted within eight years. The financial costs associated with Macondo reserves on a four-year time scale total \$1.8 billion while the costs on an 8-year time scale total \$3.5 billion dollars. The EROI using the MMS production equation for one well producing total reserves of 15 and 50 million barrels, respectively, from the Macondo field for four years and eight years, respectively, are presented in Table 3.

EROI estimates of 2009 ultra-deepwater oil production are based on operating costs of \$1 million per day and 10 year annualized rig costs of \$56.5 million/year plus \$100 million dollars in exploratory drilling per rig. EROI estimates based on low (25 rigs), average (27 rigs), and high (30 rigs) rig counts are given in Table 4.

Table 4. Estimated EROFI and EROI of 2009 Federal GoM Ultra-deepwater oil using three different energy intensity ratios (7 MJ/\$, 12 MJ/\$, 18 MJ/\$) and three different rig count scenario estimates. MJ/\$ = Megajoules/U.S. dollar. All values are inflation adjusted.

# of rigs	EROFI (2009 USD \$/bbl)	Energy Intensity Ratio (MJ/\$)	EROI
25 (low)	\$71	7	14:1
		12	8:1
		18	5:1
27 (avg.)	\$77	7	13:1
		12	7:1
		18	5:1
30 (high)	\$86	7	11:1
		12	7:1
		18	4:1

The EROI of oil and natural gas (BOE) produced in the ultra-deepwater of the GoM in 2009 is shown in Table 5. Again, EROI is based on low (25 rigs), average (27 rigs), and high (30 rigs) rig counts as given in Table 4. The range of EROI estimates for the Macondo Prospect and 2009 GoM ultra-deepwater energy production are presented in Figure 2.

Table 5. EROFI and EROI of Federal GoM Ultra-deepwater energy using three different energy intensity ratios (7MJ/\$, 12MJ/\$, 18MJ/\$) and three different rig count scenario estimates. MJ/\$ = Megajoules/U.S. dollar. All values are inflation adjusted.

# of rigs	EROFI (2009 USD \$/bbl)	Energy Intensity Ratio (MJ/\$)	EROI
25 (low)	\$45	7	22:1
		12	12:1
		18	9:1
27 (avg.)	\$48	7	18:1
		12	12:1
		18	8:1
30 (high)	\$54	7	18:1
		12	11:1
		18	7:1

Figure 2. Inflation adjusted standard EROI for the Macondo Prospect and 2009 ultra-deepwater total oil plus gas production calculated from EROFI using different energy intensity ratios. EROI is based on 2005 energy intensity ratios and costs in 2005 dollars. Error bars reflect potential daily production flow rates for Macondo data and different rig counts for 2009 data (see text for discussion).

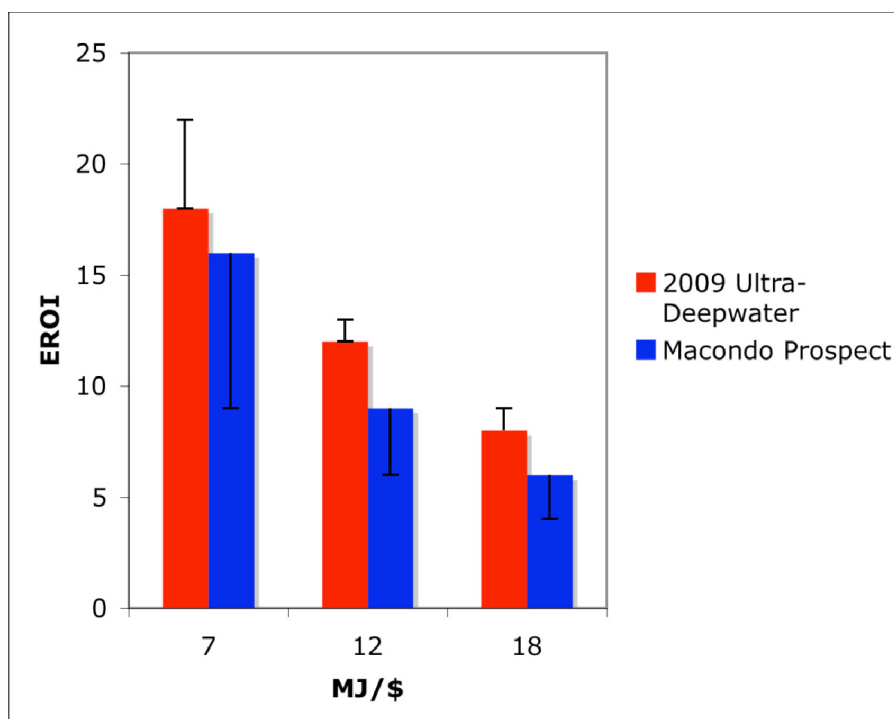

4. Discussion

Our values for EROFI at the well-head ranged from \$45/barrel to \$141/barrel. By comparison, production costs for Mideast and North Africa oil ranges from \$6/barrel to \$28/barrel [48] and for the United States overall roughly twice that. These values for the GOM indicate that if these resources are used as the basis of US oil use the price of oil would have to be in the range of current prices, which maybe too high to sustain economic growth [14,17].

Energy intensity ratios from the literature were then used to convert these results to energy-based EROI. The sensitivity analysis yielded EROI values ranging from 4–22:1. The lower end of this range of EROI may be more accurate since these values were derived using energy intensity ratios for the oil and gas industry. Increasing rig counts and time required for extraction negatively influenced EROI for the United States as a whole. EROI for domestic oil and gas has declined from 100:1 for discoveries in 1930 and about 30:1 for production in the 1950s–1970s to about 10:1 in 2005–7 [16,18]. EROI values presented in this study are in the lower range of previously published estimates for domestic oil production, especially if our preferred high energy intensities are used. The EROI for oil and gas at the well-head in ultra-deepwater in 2009 ranged from 7–22:1, while the EROI for oil alone in ultra-deepwater was 4–14:1. Most of the variability was our choice of energy intensities used per dollar, The Macondo Prospect EROI for oil alone using the MMS production profile curve yielded a similar EROI of 4–16:1 based on estimates of varying reserve sizes and costs associated with extraction. The constant flow rate scenario for the Macondo Prospect yielded similar results in the range of 7–20:1. These values fit the trend of decreasing EROI over time as oil was produced from increasingly expensive fields.

Our EROI values can be compared to other reports of EROI for energy production processes including 80:1 for coal, 12–18:1 for imported oil, 5:1 or less for shale oil, 1.6 to 6.8:1 for solar, 18:1 for wind, 1.3:1 for biodiesel, 0.8 to 10:1 for sugarcane ethanol, and 0.8 to 1.6:1 for corn-based ethanol [3,44].

The EROI values of this study were based on financially-derived energy costs of production at the well-head only, and did not include all of the indirect costs of delivery to end use. Thus, these estimates are conservative. If all indirect costs were included in the EROI calculations, EROI would decrease. This underscores the need to make accessible better energy accounting information so that more refined analyses of the EROI of ultra-deepwater energy extraction can be carried out. Unfortunately, funding is being cut for the U.S. Energy Information Agency, the agency charged with providing such information to the public [49]. The lack of data availability regarding energy extraction costs in the GoM makes it difficult for the individuals, interest groups, and political representatives to make wise decisions regarding offshore energy policy. Informed decision-making on energy policy is essential to the long-term sustainability of society.

One of the energy cost factors only partially included in this study is the number of exploratory *vs.* development wells drilled in the ultra-deepwater in 2009. Exploratory wells are necessary for new discovery and in the period from 2004–2008, 226 wells were drilled in the ultra-deepwater GoM, 31% of which were successful [9]. The number of exploratory *vs.* development wells drilled in 2009 was not factored into the EROI calculations of this study due to data availability constraints. The impact on EROI would depend on how many of the exploratory wells ultimately produce oil and in what

quantity. In addition, the insurance costs associated with rigs operating in ultra-deepwater were not included but are estimated by market analysts to range between 10–35% of the present value of the rig [50]. For a \$500 million dollar rig, that would add between \$50–\$175 million in insurance costs per year of operation. If all of these costs were included it might decrease the EROI by perhaps 25 percent.

More expensive, higher capacity rigs produce higher EROI oil when producing from large reservoirs with high daily flow rates. As daily production declines from the plateau phase, the EROI of the well decreases since the same operational and infrastructural costs are being utilized to produce less oil and gas. The tendency to ramp up production early in the production process to get the maximum possible production rates, leads to more rapid decline rates of deep and ultra-deepwater wells [4,21]. High capital costs of production require fast turnaround times to bring energy to market and recoup capital expenditures. Long-term production potential is bypassed for short-term market decision-making. As profit margins decline with decreasing production, marginal wells must be abandoned so that the drilling resources can be utilized at more productive wells. The constant need to keep rigs in profitable production requires a consistent amount of exploratory drilling and new discoveries. Regardless of oil price, the energy required to extract the resource is relatively constant and increases with depth [10]. Thus, the rate of extraction and timing affects economic profitability but the net energy remains generally the same. Technological advancement may increase efficiency of extraction over time, thereby increasing energy return on investment but technology comes at the cost of research and development funding. A difficult situation arises when drilling contractors are prevented from accessing the resource either through federal regulation, as happened in 2010, or as a result of declining oil prices and decreasing production profitability. The latter is minimized through long-term contractual obligations. At the same time, the limited number of rigs in the deepwater drilling industry helps to maintain high usage rates for rigs in existence. Whenever a contract goes un-renewed, that rig is often moved to another basin or resource pool where the rig can be put into operation for another contractor. This optimal use of rigs tends to increase EROI. The actual price of oil at any given time is essentially the same worldwide, regardless of energy costs of producing the oil. Thus, the price for deep and ultra-deepwater oil is sub-optimal when world oil prices are low.

A factor contributing to the increased drilling in the deep and ultra-deepwater of the GoM are federal government subsidies to drilling companies. This increases financial profitability for oil companies but does not affect EROI. According to the Federal Land Policy and Management Act [51], the Department of Interior is required by law to ensure that “the United States receive fair market value of the use of public lands and their resources unless otherwise provided for by statute”.

Subsidy statutes applying to deepwater energy production, that circumvent the fair market value provision, are mainly the result of the Deepwater Royalty Relief Act (DWRRA) and the Energy Policy Act of 2005. The Deepwater Royalty Relief Act granted exploration leases issued between 1996 and 2000 an exemption from paying the government royalties on oil produced by wells that would not otherwise be economically viable. The program has been extended since its original expiration date in 2000. In addition, the Energy Policy Act put an oil-price threshold below which producers would not have to pay the government royalties thereby providing further incentive for companies to drill in the offshore GoM.

Numerous studies have shown royalties paid to the government for GoM offshore production are among the lowest rates paid to any fiscal system in the world [52,53]. The government is effectively

subsidizing the most profitable corporations in the world at the expense of public taxpayers. These subsidies provide false market signals to continue energy supply processes that otherwise would not be competitive, thereby reducing economic efficiency [54]. This encourages oil companies to go after low EROI oil reserves that would likely not be produced without subsidies. Such subsidies further obscure reality by causing alternative energy markets to be less cost competitive [55].

Another indirect cost not accounted for in this study includes the cost of the loss of the value of ecosystem services as a result of federal offshore energy production. Air and water pollution attributed to the oil and gas industry are market externalities that in reality have costs borne by society. Ecosystem degradation in the form of wetland loss, partly as a result of oil and gas industry infrastructure, has increased the risk of natural disasters to coastal communities [56]. Batker *et al.* [57] carried out a partial assessment of the value of ecosystem services of the Mississippi River delta. They reported an annual value of ecosystem services of \$12 to \$47 billion and a minimum natural capital asset value of the delta of \$330 billion to \$1.3 trillion.

The damage to marine and coastal environments associated with the Macondo Prospect blowout is substantial. Commercial fisheries production and economic losses to the coastal tourism sector are expected to cost tens of billions of dollars. Including such costs in the analysis would likely cause the Macondo Prospect EROI to be negative. Ecosystem service values are largely outside the scope of the market economy, thereby discounting their importance to society.

Acknowledgements

We would like to thank Charles Hall for assisting with the development of the methodology employed in this paper and for his comments on the paper and Mark Gately at the Rocky Mountain Institute in Boulder, Co. for the information he offered in improving upon previous EROI estimates in the GoM. The comments of an anonymous reviewer were also extremely helpful.

References and Notes

1. Hofmeister, J. Shell Oil Company; Statement before the House Select Committee on Energy Independence and Global Warming. Washington, DC, USA, 1 April 2008.
2. Robertson, P.J. Chevron Corporation; Statement before the House Select Committee on Energy Independence and Global Warming. Washington, DC, USA, 1 April 2008.
3. Hall, C.A.S.; Day, J.W. Revisiting the limits to growth After Peak Oil. *Am. Sci.* **2009**, *97*, 230-237.
4. Kaiser, M.J.; Yu, Y.; Pulsipher, A.G. Assessment of marginal production in the Gulf of Mexico and lost production from early decommissioning. Prepared for the U.S. Department of the Interior, Minerals Management Service: Gulf of Mexico OCS Region. April, 2010. MMS 2010-007.
5. Ultra-Deepwater Advisory Committee (UDAC). A Federal Advisory Committee to the U.S. Secretary of Energy Meeting Minutes. San Antonio, TX, USA, 16-17, September 2009. Available online: www.fossil.energy.gov/programs/oilgas/ultra_and_unconventional/2010_Annual_Plan/11th_UDAC_Meeting_Minutes.pdf (accessed on 23 June 2011).

6. USA Central Intelligence Agency World Factbook 2010. Available online: <https://www.cia.gov/library/publications/the-world-factbook/fields/2174.html> (accessed on 26 January 2011).
7. USA Energy Information Agency Crude Oil Proved Reserves, Reserve Changes, and Production; Federal Offshore Louisiana and Texas 2010. Available online: http://www.eia.gov/dnav/pet/pet_crd_pres_dcu_R1901F_a.htm (accessed on 1 February 2011).
8. USA Department of Energy. Offshore Technology Roadmap for the Ultra- Deepwater Gulf of Mexico, November 2000. Available online: fossil.energy.gov/programs/oilgas/publications/oilgas_generalpubs/offshore_GOM.pdf (accessed on 26 January 2011).
9. USA Minerals Management Service. *2009 Gulf of Mexico Oil and Gas Production Forecast 2009–2018*, OCS Report MMS 2009–012; New Orleans, Louisiana May 2009. Available online: www.gomr.boemre.gov/PDFs/2009/2009-012.pdf (accessed on 26 January 2011).
10. Gately, M. The EROI of US offshore energy extraction: A net energy analysis of the Gulf of Mexico. *Ecol. Econ.* **2007**, *63*, 355-364.
11. Dismukes, D.E.; Olatubi, W.O.; Mesyanzhinov, D.V.; Pulsipher, A.G. Modeling the Economic Impacts of Offshore Oil and Gas Activities in the Gulf of Mexico: Methods and Applications. Prepared by the Center for Energy Studies, Louisiana State University, Baton Rouge, La. U.S. Department of the Interior, Minerals Management Service, Gulf of Mexico OCS Region, New Orleans, Louisiana, 2003. MMS 2003–018.
12. Costanza, R.; Herendeen, R.A. Embodied energy and economic value in the United States economy 1963, 1967, and 1972. *Resour. Energy* **1984**, *6*, 129-163.
13. Gately, M. Rocky Mountain Institute: Boulder, CO, USA. Personal Communication, August 2010.
14. King C.W.; Hall, C.A.S. Relating financial and energy return on investment. *Sustainability* **2011**, *3*, 1810-1832.
15. Guilford, M.C.; Hall, C.A.S.; Cleveland, C.J. A new long term assessment of EROI for U.S. Oil and gas production. *Sustainability* **2011**, *3*, 1866-1887.
16. Cleveland, C.J.; Costanza, R.; Hall, C.A.S.; Kaufmann, R. Energy and the United States economy- A biophysical perspective. *Science* **1984**, *225*, 890-897.
17. Hall, C.A.S.; Balogh, S.; Murphy, D.J.R. What is the minimum EROI that a sustainable society must have? *Energies* **2009**, *2*, 25-47.
18. Cleveland, C.J. Net energy from the extraction of oil and gas in the United States. *Energy* **2005**, *30*, 769-782.
19. USA Minerals Management Service. *Energy Information Agency Office of Oil and Gas; Gulf of Mexico Fact Sheet 2010*. Available online: www.eia.doe.gov/special/gulf_of_mexico/index.cfm (accessed on 1 February 2011).
20. IHS CERA. *The Role of Deepwater Production in Global Oil Supply*. Cambridge Energy Research Associates: Cambridge, MA, USA, 2010. Available online: <http://press.ihc.com/press-release/energy-power/ihc-cera-role-deepwater-production-global-oil-supply> (accessed on 1 February 2011).
21. S. Gavin ODS-Petrodata Consulting & Research; Presentation entitled “The outlook for offshore drilling” presented in Beijing and Singapore 19 and 22 March 2010. Available online: <http://www.ods-petrodata.com/odsp/presentations.php> (accessed on 1 February 2011).

22. Anderson, R.N.; Boulanger, A. *Prospectivity of the Ultra-Deepwater Gulf of Mexico*. Lean Energy Initiative Lamont-Doherty Earth Observatory Columbia University; Palisades, NY, USA, 2002. Available online: leanenergy.ldeo.columbia.edu/docs/UltraDeep%20Prosp%2010-22-02.pdf (accessed on 1 February 2011).
23. USA Bureau of Ocean Energy Management, Regulation and Enforcement. *Technology Assessment & Research (TA&R) Project Categories: Offshore Structures*, 2010. Available online: <http://www.boemre.gov/tarprojectcategories/structur.htm> (accessed on 1 February 2011).
24. National Subsea Research Institute. *Research aims to double the lifespan of oil rigs*. Professional Engineering 21 April 2010. Available online: <http://www.highbeam.com/doc/1P3-2034033771.html> (accessed on 1 June 2011).
25. Sharma, R.; Kim, T.; Sha, O.P.; Misra, S.C. Issues in offshore platform research-Part1: Semi-submersibles. *Int. J. Nav. Archit. Ocean Eng.* **2010**, *2*, 155-170.
26. USA Department of Energy. *Offshore Roadmap 2000*. Available online: fossil.energy.gov/programs/oilgas/publications/oilgas_generalpubs/offshore_GOM.pdf (accessed on 1 February 2011).
27. Triepke, J. *Analysis: 2009 Jackup Market Review*. Rigzone: Houston, TX, USA, 11 December 2009. Available online: http://www.rigzone.com/news/article.asp?a_id=83956 (accessed on 1 February 2011).
28. Klump, E. *Anadarko May Take Biggest Hit from Gulf Oil Spill*. Bloomberg News Service: New York City, NY, USA, 13 May 2010. Available online: <http://www.bloomberg.com/news/2010-05-13/anadarko-may-take-biggest-hit-from-gulf-oil-spill-as-bp-s-silent-partner.html> (accessed on 1 February 2011).
29. Scherer, R. *What if BP taps leaking Macondo well again?* Christian Science Monitor: Boston, MA, USA, 19 May 2010. Available online: <http://www.csmonitor.com/USA/2010/0519/Gulf-oil-spill-What-if-BP-taps-leaking-Macondo-well-again> (accessed on 1 February 2011).
30. Offshore-technology.com. *Deepwater Horizon: A Timeline of Events*. Available online: <http://www.offshore-technology.com/features/feature84446/> (accessed on 1 February 2011).
31. Offshore Drilling Monthly. Jefferies & Company, Inc.: New York, NY 10022, January-December Issues 2009.
32. Rigzone Inc. *Offshore Rig Day Rates*. <http://www.rigzone.com/data/dayrates/> (accessed on 31 May 2011).
33. Leimkuhler, J. *Shell Oil: How Do We Drill For Oil?* Presented at the 2nd Annual Louisiana Oil & Gas Symposium, Baton Rouge, Louisiana, USA, August 2010.
34. Rigzone Inc. *Today's Trends: Offshore Rig Construction Costs*. http://www.rigzone.com/news/article.asp?a_id=87487 (accessed on 1 February 2011).
35. Hall, C.A.S.; Cleveland, C.J. Petroleum drilling and production in the United States, yield per effort and net energy analysis. *Science* **1981**, *211*, 576-579.
36. Murphy, D.J.; Hall, C.A.; Dale, M.; Cleveland, C. Order from chaos: A preliminary protocol for determining the EROI of fuels. *Sustainability* **2011**, *3*, 1888-1907.
37. USA Energy Information Agency. *Annual Energy Outlook 2011 Report #:DOE/EIA-0383 ER*, 2011. Available online: http://www.eia.doe.gov/forecasts/aeo/early_intensity.cfm (accessed on 1 February 2011).

38. King, C.W. Energy intensity ratios as net energy measures of United States energy production and expenditures. *Environ. Res. Lett.* **2010**, *5*, 044006.
39. Mulder, K.; Hagens, N.J. Energy return on investment: Toward a consistent framework. *Ambio* **2008**, *37*, 74-79.
40. Berman, A. *Causes and Implications of the BP Gulf of Mexico Oil Spill Presented at ASPO-USA World Oil Conference*. Labyrinth Consulting Services Inc.: Washington, DC, USA, 9 October 2010.
41. USA Minerals Managements Service. *2007 Gulf of Mexico Oil and Gas Production Forecast 2007–2016. OCS Report MMS 2007–020*: New Orleans, LA, USA, May 2007.
42. USA Minerals Managements Service. *2009 Gulf of Mexico Oil and Gas Production Forecast 2009–2018*, OCS Report MMS 2009–012: New Orleans, LA, USA, May 2009.
43. Triepke, J. *Analysis: 2009 Floater Rig Market Review*. Available online: http://www.rigzone.com/news/article.asp?a_id=84343 (accessed on 1 February 2011).
44. Murphy, D.J.; Hall, C.A.S. Year in review-EROI or energy return on (energy) invested. In *Ecological Economics Reviews*; Wiley-Blackwell, Ames, IA, USA, 2010; Volume 1185, pp. 102-118.
45. Carnegie Mellon University Green Design Institute. *Economic Input-Output Life Cycle Assessment (EIO-LCA), US 1997 and 2002 Industry Benchmark model*. Available online: <http://www.eiolca.net> (accessed on 28 February 2011).
46. United States Department of Labor, Bureau of Labor Statistics. *CPI Inflation Calculator*. Available online: http://www.bls.gov/data/inflation_calculator.htm (accessed on 8 July 2011).
47. Weglein, A.B. Statement before the Subcommittee on Energy and Air Quality of the Committee on Energy and Commerce. The Ultra Deepwater Research and Development: What are the Benefits? Serial No. 108-77. 108th Congress U.S. House of Representatives: Washington, DC, USA, April 29, 2004. Available online: <http://www.access.gpo.gov/congress/house/house05ch108.html> (accessed on 4 April 2011).
48. International Energy Agency. *World Energy Outlook 2008*. ISBN 978-92-64-04560-6 Available online: <http://www.iea.org/w/bookshop/add.aspx?id=353> (accessed on 23 June 2011).
49. USA Energy Information Agency. *Immediate Reductions in EIA's Energy Data and Analysis Programs Necessitated by FY 2011 Funding Cut*. U.S. Energy Information Administration: Washington D.C., USA; April 28, 2011. Available online: <http://www.eia.gov/pressroom/releases/press362.cfm> (accessed on 20 May 2011).
50. Slanis, B. *Willis Group Holdings: "Upstream insurance" Presented at the 2nd Annual Louisiana Oil & Gas Symposium*. Baton Rouge, Louisiana, USA, August 2010.
51. USA Congress. *Federal Land Policy and Management Act. Declaration of Policy. U.S. Code 43, Section 1701(a)(9)*. U.S. Congress: Washington D.C. USA, 2007. Available online: <http://codes.lp.findlaw.com/uscode/43/35/1/1701> (accessed on 1 February 2011).
52. USA Government Accountability Office. *Oil and Gas Royalties: A Comparison of the Share of Revenue Received from Oil and Gas Production by the Federal Government and Other Resource Owners*, Report No. GAO-07-676R; U.S. GAO: Washington D.C., USA, 1 May 2007; p. 3. Available online: www.gao.gov/products/GAO-07-676R (accessed on 16 October 2011).

53. USA Government Accountability Office (GAO). *Oil and Gas Royalties: The Federal System for Collecting Oil and Gas Revenues Needs Comprehensive Reassessment*; U.S. GAO: Washington D.C., USA. September 2008; p. 6. Available online: www.gao.gov/new.items/d08691.pdf (accessed on 16 October 2011)
54. Freudenburg, W.R.; Gramling, R.; Laska, S.; Erikson, K.T. Organizing hazards, engineering disasters? Improving the recognition of political-economic factors in the creation of disasters. *Soc. Forces* **2008**, *87*, 1015-1038.
55. Environmental Law Institute 2009. *Estimating U.S. Government Subsidies to Energy Sources: 2002-2008*. The Environmental Law Institute: Washington, D.C., USA. Available online: http://www.eli.org/Program_Areas/innovation_governance_energy.cfm (accessed on 16 October 2011)
56. Costanza, R.; Perez-Maqueo, O.; Martinez, M.L.; Sutton, P.; Anderson, S.J.; Mulder, K. The value of coastal wetlands for hurricane protection. *Ambio* **2008**, *37*, 241-248.
57. Batker, D.; de la Torre, I.; Costanza, R.; Swedeen, P.; Day, J.W.; Boumans, R.; Bagstd, K. *Gaining Ground: Wetlands, Hurricanes and the Economy: The Value of Restoring the Mississippi River Delta*. Earth Economics: Tacoma, WA, USA; 2010. Available online: www.eartheconomics.org/FileLibrary/file/Reports/Louisiana/Earth_Economics_Report_on_the_Mississippi_River_Delta_compressed.pdf (accessed on 1 February 2011).

© 2011 by the authors; licensee MDPI, Basel, Switzerland. This article is an open access article distributed under the terms and conditions of the Creative Commons Attribution license (<http://creativecommons.org/licenses/by/3.0/>).

Part III: EROI for Other Fuels

Review

Seeking to Understand the Reasons for Different Energy Return on Investment (EROI) Estimates for Biofuels

Charles A.S. Hall ^{1,*}, Bruce E. Dale ² and David Pimentel ³

¹ College of Environmental Science and Forestry, State University of New York, Syracuse, New York, NY 13210, USA

² Michigan State University, East Lansing, MI 48824, USA; E-Mail: bdale@msu.edu

³ Cornell University, Ithaca, NY 14853, USA; E-Mail: dp18@cornell.edu

* Author to whom correspondence should be addressed; E-Mail: chall@esf.edu;
Tel.: +1-315-470-6870; Fax: +1-315-470-6934.

Received: 5 July 2011; in revised form: 17 November 2011 / Accepted: 24 November 2011 /

Published: 13 December 2011

Abstract: The authors of this paper have been involved in contentious discussion of the EROI of biomass-based ethanol. This contention has undermined, in the minds of some, the utility of EROI for assessing fuels. This paper seeks to understand the reasons for the divergent results.

Keywords: Ethanol; EROI; corn-based; cellulosic

1. Introduction

We are in a time of profound transition in how the world will be fueled and fed. The fossil energy resources (petroleum, coal and natural gas) that have powered the world's economy since the initiation of the industrial revolution are increasingly problematic in terms of their price (and price volatility), security of supply, declining energy return on investment (EROI) and environmental impacts [1]. These issues are well known and will not be discussed further here.

There is a less well known, but very important, positive correlation between the amount of energy that a society has at its disposal and the wealth of that society. Richer societies invariably have more energy available to them than do poorer societies [2-5] Energy consumption is a key factor associated with the greater wealth of richer societies, which makes sense if economic production is thought of as a work process, with more economic production requiring more energy. Billions of people have no

access to modern energy services and they are almost invariably poor in economic terms. If fossil fuels are increasingly problematic in cost, availability and environmental impacts, what energy resources, if any, are available to help lift these billions of humankind from their poverty?

For these and other reasons, alternatives to fossil fuels, and especially alternatives to petroleum, are being explored worldwide. The poor often have substantial biological resources that might be mobilized for the kinds of fuels that are especially useful in generating wealth. Biofuels (liquid fuels made from plant matter) might be affordable alternatives to petroleum with a low carbon footprint and therefore appear to some investigators attractive as a petroleum alternative. One downside is that this organic matter might have other good functions, such as maintaining soil fertility or forest biodiversity. The only large scale petroleum alternatives currently available for liquid transportation fuels are biofuels, principally ethanol made from cane sugar or corn starch, and smaller amounts of biodiesel produced from oilseeds. At present corn-based ethanol provides for about 10% by volume of US motor “gasoline” [5], although this is clearly for gross energy and not net energy. The sustainable resource base could be expanded considerably if we were able to use cellulosic biomass as a feedstock (e.g., some portion of crop residues (although coauthor Pimentel believes that no portion of crop residues should be harvested [6], woody materials, grasses and herbaceous crops) in addition to starch and sugar feedstocks. The starches and sugars are much easier to ferment with present day technologies but the cellulosic resource base is considerably larger and appears to have many desirable environmental properties.

However, biofuels are controversial. Their environmental impacts, cost, potential scale and EROI have all been questioned. If we are to make informed and rational choices between our alternatives to petroleum, these questions must be addressed and resolved. This article focuses on the EROI for biofuels. The different results derived from different investigators (including, perhaps especially, ourselves) have caused some prominent analysts to disparage EROI as not being useful because of the highly divergent results of different investigators [7,8] We emphasize here corn ethanol, for which most of the EROI analyses have been done, and cellulosic ethanol, a possibly promising new alternative to petroleum gasoline. Indeed the controversy about EROI for corn-based ethanol, usually formulated as whether or not corn-based ethanol makes a positive energy gain relative to the fossil fuels used to produce them, is probably the issue by which most scientists and policy makers have encountered EROI.

It is important that we determine whether it is possible to get reliable estimates of EROI for a given fuel. The corn-based ethanol industry is mature and we can derive reasonable empirical results. A number of corn ethanol EROI (or “net energy”) studies have been performed) which are reported in metastudies by Farrell *et al.* [7], Hammerschlag (2005, [9]) and Chavas (2008, [10]). From among these studies, a large difference in values can be found by comparing the results of Kim and Dale [11], who give an EROI for corn-based ethanol of 1.73:1 and Pimentel and Patzek [12] (who give a value of 0.82:1).

In this paper we seek the reasons for these large differences, and explore whether they are due to the measured, verifiable process-related energy consumption for individual processes or instead primarily on boundary and/or other philosophical assumptions or, perhaps, something else. If the reason is the former then indeed there may be some basis for the criticisms leveled at EROI methodology, if the

second then these issues are readily accommodated within the EROI protocol format put forth in this issue by Murphy *et al.* [13].

There are three basic reasons for the differences in EROIs as determined by different investigators: procedural/metric issues, philosophical and boundary issues and quality adjustment issues. We discuss each briefly.

1.1. Procedural/Supply Chain Issues

We use the term *supply chain* to refer to issues pertaining to the derivation of energy costs, measured per unit input, per unit product or per ha, associated with the various inputs to the production processes. For example if we know that to grow 60 kg (approximately 1 MJ) of maize requires, on average, about one kg of fertilizer, there are various studies that have been done that can give a fairly unambiguous and limited range of energy values associated with that production (Table 1). Similarly it is possible to derive straightforward estimates of the energy to run a tractor pulling a standard plow for one hour, and to derive the hours required per ha. It becomes more difficult to derive other factors that are not based on simple physical variables; for example, the energy that was used to make and maintain the tractor used, and even the building in which the tractor was produced. But while we do not have look up tables for the energy to make a kg or a unit of a certain tractor, we do have various estimates of energy used per dollar of product in various machinery production facilities, often gathered, when it is possible, from national aggregate statistics. Then that has to be prorated over the useful life of the tractor. We include some of these estimates and their ranges in Table 1 also.

1.2. Philosophical and Boundary Issues

A second issue relating to different energy costs among different authors pertains to *boundaries and philosophies of inclusion/exclusion*. It is nearly universally accepted that one should include direct (on site) energy use and basic indirect (e.g., energy used to make equipment used on site) energy inputs. However, the agreement tends to evaporate when considering whether or not to include other possible energy terms, for example; allocation to coproducts, energy for labor or finance and so on. We do not believe that there is a single acceptable boundary (although one should undertake a standard assessment for fuel alone and then clearly specify procedures for each additional analysis). However, comparative studies must use the same boundaries if they are to provide useful results. This issue is addressed in the protocol paper by Murphy *et al.* [13] in this volume. Good arguments for including all components associated with expenditures are found in [14].

If the different published EROIs for biofuel are due principally to such philosophical issues then this would not undermine the value of EROI as a key metric for analyzing energy systems, or at least not very much. In fact the different approaches can be viewed as a means of gaining greater flexibility and hence utility for EROI by specifying the conditions of the process under consideration, especially if a standard procedure is also done [13]. In addition the different investigations highlight the importance of clearly defining the assumptions made during the EROI analysis and how allocations are handled for multiproduct energy systems.

1.3. Quality Adjustment Issues

Not all energy is of the same quality, for example liquid fuels are normally thought of as higher quality than solid fuels (hence we transform corn to alcohol). Electricity is higher quality than fossil fuels, hence we burn some three heat units of fossil fuel to generate one heat unit of electricity. Gasoline has higher energy density than alcohol and so on.

We believe that these are the three main reasons that contribute to differences among different estimates of the EROI of the same fuel. The main objective of this paper is to take two very different estimates of EROI and dissect the reasons for the differences.

2. Methods

Our methods are very simple. We examine the importance of each of the above three factors quantitatively in Kim and Dale [11] and Pimentel and Patzek [12] by comparing each energy-related component in tabular form. Our main activity was to list energy consuming operations and to convert units, for example from Pimentel and Patzek's kilocalories to megajoules (MJ, multiply kilocalories by 4.186/1000). In all cases energy operations were given in, or converted to, estimates of MJ/L of alcohol generated.

The second main procedure was to examine the importance of the allocation (or not) of energy costs to co-products. The energy costs of producing corn ethanol can be partially offset by allocating the energy used to various products and by-products, such as the dry distillers grains (DDG) made from dry-milling of corn. From about 10 kg of corn feedstock, about 3.3 kg of DDG with 27% protein content can be harvested [15]. This DDG is suitable for feeding cattle that are ruminants, but has only limited value for feeding hogs and chickens. In practice, this DDG is generally used as a substitute for soybean meal that contains 49% protein [15]. This allocation issue is somewhat complex. Soybean production for livestock feed requires less energy per kg than does corn production, because little nitrogen fertilizer is needed for the production of the soybean. However considerable energy is required to remove oil from soybeans and thereby produce the soybean meal that is actually fed to animals. In practice 2.1 kg of soybean protein provides the equivalent nutrient value of 3.3 kg of DDG.

In the system expansion approach used in Kim and Dale [11], the system boundaries were expanded to include corn dry milling, corn wet milling, and soybean crushing systems. Simultaneous linear equations representing the displacement scenarios for co-products of each system were solved as recommended by the International Standards Organization [16]. The underlying assumption is that co-products that deliver an equivalent function (DDG as an animal feed, in this case) from different product systems displace each other. The fraction of energy allocated to co-products (26%) was then estimated through system expansion. Pimentel and Patzek [12], in contrast, assume that 7% of the overall energy inputs will be allocated to co-products. Consequently, we examined the effect of allocating zero, 7% (coauthor Pimentel's value) or 26% of the energy used (coauthor Dale's value) to produce ethanol to DDG (see the Results section).

3. Results

Since the methods and the results for the corn based ethanol EROI and the cellulosic ethanol EROI are quite different we give first the results for corn-based ethanol, then we include additional methods and new results for cellulosic ethanol.

3.1. Results for Corn-Based Ethanol

The two procedures gave a very different EROI for corn based ethanol, 1.73:1 from Kim and Dale [11] and 0.82:1 from Pimentel and Patzek [12]. Obviously Kim and Dale estimate that a positive energy balance can be generated by turning inputs into ethanol. Pimentel and Patzek [12] conclude that investing fossil energy to make ethanol from corn is senseless because the process of generating ethanol consumes more energy than is derived from the product ethanol.

The principal reason for the large difference between the EROIs derived from these two papers was the difference in the allocation approaches used for coproducts. Kim and Dale used the “system expansion” approach to estimate that only 74% of the total energy costs should be allocated to generating the ethanol and the remainder to the co-product, the protein rich DDG. In brief, the system expansion allocation employed by Kim and Dale assigned the energy “cost” of producing soy bean meal, the major commodity with which DDG competes in the market, to DDG. About a half (approximately, depending on assumption used) of the difference between the EROI given in the Pimentel and Patzek and the Kim and Dale papers was due to co-product allocation issues (*i.e.*, philosophical and boundary issues). About a third was due to differences in estimates of the energy intensity of the inputs (*i.e.*, supply chain issues), and about 15% was due to the greater inclusivity of costs by Pimentel and Patzek. These results are considered in greater detail next.

3.2. Supply Chain Issues: Energy per Unit Inputs

Table 1 gives the energy intensities per unit used in their analyses by the two sets of authors. The inputs are listed side by side in Table 1 so that they can be compared easily. The per unit values used in making subsequent calculations are almost universally within 10 or at most 20% of one another (Table 1). The values used by Pimentel and Patzek tend to be often, but not always, higher than those of Kim and Dale. For example, the former give diesel fuel as 42.6 and the latter 47.5 MJ/L. Since Pimentel and Patzek include the energy required to refine the fuels, which is about 10% of the output value [17], and Kim and Dale do not, this seems to be the reason for the difference. Exceptions to the general similarities are the energy costs per ton of potassium fertilizer, which differ by 30%, and transport energy which differ by 70%. Neither of these energy inputs is especially large, so we do not think that differing per unit energy costs are likely to contribute in any important way to the final results with the exception of items included by one study but not the other.

Table 1. Energy Costs Per Physical Unit or Per Dollar of Input to Agriculture or Biorefining.

Entity	Units	Energy Cost	
		Kim & Dale (2005)	Pimentel & Patzek (2008)
Diesel	MJ/L	42.6	47.5
Electricity	MJ/kwhr	9.61	10.8
Natural Gas	MJ/L	0.04	Not determined
Fuel oil	MJ/L	43.2	Not determined
Coal	MJ/kg	23.1	Not determined
Gasoline	MJ/L	40.5	42.4
LPG	MJ/L	27.1	Not determined
Methanol	MJ/L	21.2	21.5
Steel	MG/kg	Not determined	96.4
Stainless Steel	MJ/kg	Not determined	230
Cement	MJ/kg	Not determined	202
Fertilizer Nitrogen	MJ/kg	63.7	67
Fertilizer Phosphorus	MJ/kg	18	17.4
Fertilizer Potassium	MJ/kg	8.22	13.7
Lime	MJ/kg	1.46	1.17
Irrigation	GJ/cm	Not determined	166
Pesticides	MJ/kg	426	419
Herbicides	MJ/kg	437	419
Machinery	GJ/\$1000	Not determined	73.4
Transport	MJ/ton-km	Not determined	73.4

Since there was no consistent pattern of one or the other authors using higher or lower estimates the energy input estimates tend to “come out in the wash”. The estimates of the total energy used to generate a liter of ethanol differ more because of the inclusion or not of different costs. Pimentel and Patzek include more categories of inputs and hence estimate the total energy input to generating a liter of ethanol as 28.1 MJ, while Kim and Dale estimate 16.7 MJ, which is 59% of Pimentel and Patzek’s value. If one assigns additional energy costs (based on Pimentel and Patzek’s numbers) for the factors used by Pimentel and Patzek but not by Kim and Dale the latter’s energy costs would be 19.5 MJ/L, 69% of the former’s value.

3.3. Sensitivity Analysis

Both Kim and Dale [11] and Pimentel and Patzek [12] allocate some energy costs to coproducts. For the Kim and Dale this is 26% (about 445 kcal or 1.86 MJ) per liter, while for Pimentel and Patzek it is 7% (about 120 kcal or 0.5 MJ) per liter. In the case of Pimentel and Patzek factoring this credit for a non-fuel source in the production of ethanol reduces the negative energy balance from 46% to 39% (See tables). For Kim and Dale it increases the positive value by about 18%. Some scientists, such as Shapouri *et al.* [18], would give an even larger credit for DDG of 4,400 kcal (18.4 MJ) / kg and thereby further increase the positive value of EROI relative to Kim and Dale. Shapouri’s values are based on surveys of operating corn ethanol plants.

Table 2. Corn Ethanol: Comparing Different EROI Calculations.

	Energy inputs (MJ/L of ethanol of fuel generated)	
	Input (MJ/L ethanol)	
	Kim & Dale 2005	Pimentel & Patzek 2008
Agriculture:		
Fuel	0.76	1.69
Machinery	Not determined	1.22
Electricity	Not determined	0.05
Fertilizer	2.29	3.69
Lime	Not determined	0.38
Irrigation:		
Pesticides/Herbicides	Not determined	1.08
Seeds	Not determined	0.62
Feedstock Transport	0.46	0.20
Total for Corn Production	3.51	10.03
(Estimate for Not Determined items)	2.65	(2.65)
Total including Not Determined	6.16	10.03
Biorefinery:		
Fuel	10.60	11.08
Electricity	1.54	4.23
Steel	0.31	1.08
Misc	Not determined	0.33
Total energy input	12.45	16.72
Ethanol Distribution	0.60	1.39
Total energy input	16.56	28.14
(Estimate for Not Determined items)	2.98	(2.98)
Total input incl all categories	19.54	28.14
Total Energy Output	21.20	21.479
Energy Return on Investment	1.28	0.76
EROI (with added "Not Determined")	1.10	0.76
Percentage allocated to ethanol	74	93
Input with correction for coproduct	12.25	26.17
EROI with coproduct	1.73	0.82

4. Discussion: Corn-Based Ethanol

4.1. Procedural/Metric Issues: Total Energy Costs

The estimated total energy costs to generate ethanol from corn derived by Kim and Dale are about 16.6 MJ/L, and about 28.1 MJ/L as derived by Pimentel and Patzek. Thus Pimentel and Patzek's estimates are about 170% of those of Kim and Dale (2005). About 2.65 MJ/L of the 11.6 MJ/L difference between the two estimates, or 23%, is due to what might be considered boundary (or perhaps more accurately inclusionary) issues (*i.e.* Pimentel and Patzek include more categories, such as the energy cost of seeds), and the rest due to the frequently somewhat higher estimates of energy costs at each step by Pimentel and Patzek. For most of the items the estimates of energy costs are similar, again within 10-20%, although usually higher in Pimentel and Patzek's work. The largest

differences are for fuels used in the field for production and for fertilizer plus herbicides/pesticides. The difference of energy used for fuels is mostly Pimentel and Patzek's inclusion of the energy cost of refining in the cost of oil. Fertilizer energy inputs are also a significant source of difference, with Kim and Dale estimating fertilizer energy inputs at about 1.4 MJ/L ethanol less than Pimentel and Patzek, or about 8% (0.93/11.6) of the difference in total energy inputs between the two sets of authors.

4.2. Allocation Issues

Pimentel agrees with Dale that it may be appropriate under some circumstances to include adjustments for co-products. For example the energy and dollar costs of producing corn ethanol can be partially offset by allocating some of the energy used to generate by-products, like the DDG made from dry-milling of corn. From about 10 kg of corn feedstock, about 3.3 kg of DDG with a 27% protein content can be harvested [15]. This DDG is suitable for feeding ruminants, but has only limited value for feeding hogs and chickens. In practice, this DDG is generally used as a substitute for soybean feed that contains 49% protein [15]. However, soybean production for livestock feed is more energy efficient than corn production, because little or no nitrogen fertilizer is needed for the production of the soybean legume. In practice, only 2.1 kg of soybean protein provides the equivalent nutrient value of 3.3 kg of DDG. Thus, the credit of fossil energy per kg or liter of ethanol produced should be about 1.861 MJ/L. Factoring this credit for a non-fuel source in the production of ethanol reduces the negative energy balance from 46% to 39% (see Table 2). Some, like Shapouri *et al.* [19] give a credit for DDG of 4,400 kcal/kg DDG when reducing the energy cost of ethanol production. David Pimentel thinks this too high as the actual energy required to produce a kilogram of soy with the same nutrients is only 3,283 kcal [19,20].

Bruce Dale disagrees substantially with Pimentel's assessment mentioned above. In his opinion Pimentel and Patzek [12] underestimated the energy requirements necessary to produce soybean meal (and hence undervalues the energy allocation value from the DDG) because, in his opinion, they set the wrong system boundary. Pimentel and Patzek appear to have included just the agricultural energy used to produce soybeans but not the additional energy used to turn soybeans into the high protein soybean meal animal feed (*i.e.*, the DDG is ready to be fed to some animals). Soybeans are heated, flaked and then extracted with hexane to extract the oil, then the residual hexane is removed by heating and the oil and hexane separated in order to produce soybean meal. Bruce Dale believes that all these are energy-requiring steps that must be included in the energy cost of soybean meal and therefore must be included in the energy allocated to the production of that product. It is true that soybeans don't take much energy to produce, but we don't feed soybeans to animals, we feed high protein soybean meal that has been extensively processed using lots of energy. Thus Kim and Dale [12] included all the energy costs of producing soybean meal using ISO-approved allocation methods, and consequently calculated a much different energy allocation factor than Pimentel and Patzek (74 vs. 93% of the total energy of growing and processing corn to ethanol allocated to the ethanol produced). Dale notes that ISO recommends the systems expansion approach for allocation in multiproduct systems because it reduces subjectivity in allocation. Dale believes that the systems expansion approach also represents the actual world situation better in which products compete with each other, and net environmental impacts occur at the margin in which different products are substituted for each other.

5. Estimating EROI for Cellulosic Ethanol

5.1. Overview

Due to the inherent problems with corn ethanol, including as both Dale and Pimentel acknowledge its low or negative EROI and hence low profitability if and as subsidies are removed, there is a growing interest in using cellulosic biomass from non-food biological material to produce ethanol. However, such cellulosic biomass materials have fewer carbohydrates and more complex matrices of lignin and hemicellulose, thus complicating the ethanol conversion processes. In terms of biomass energy produced per hectare (not liquid fuel), switchgrass and willow are more productive and, of importance here, more efficient than corn in terms of fossil energy inputs versus biomass energy output [12]. The problem is that they are also more difficult to turn into liquid fuel. This analysis focuses on the potential of cellulosic biomass to serve as a liquid fuel.

The corn ethanol industry is quite mature, and the EROI values are not likely to change much without a significant change in technology, or a significant change in raw materials (e.g., providing process heat by burning biomass rather than coal or natural gas). In contrast, the cellulosic ethanol industry is just beginning to emerge and no large scale plants are available from which to extract performance data to calculate EROI values. Thus we are limited to “paper” studies. We can do this in two general ways: use existing data that is as close to possible to what we think a mature cellulosic industry might look like or make assumptions about how technologies will change by the time the industry is operational.

The cellulosic ethanol system as defined for these calculations consists of the biomass production (or “agricultural” or “field” phase) and the processing or “biorefinery” phase. These are considered separately, and then the results from each phase are combined to estimate the overall system EROI. Both Pimentel and Patzek [12] and Dale (this paper) have used the energy cost of field operations based on field studies done by others on switchgrass, a productive perennial grass.

5.2. Estimates of Field Energy Costs

It is important to note here that there are some large differences in the assumptions made by Dale and Pimentel for the methods used here. These differences are brought out in the discussion between them.

Method 1. (David Pimentel). In Pimentel’s opinion and that of his coauthor Tad Patzek the best information on actual field production of switchgrass is by Sampson and his coworkers [21,22]. Sampson’s research is based on more than 15 years of actual operation including the production (using fossil fuels) of switchgrass pellets. The data are summarized in Table 3 of the Results section.

Method 2. (Bruce Dale) Dale used energy input data from two large scale field trials for cellulosic biomass production: switchgrass [23] and willow [24]. The Schmer *et al.* paper also used literature information to estimate the energy costs and energy outputs from a cellulosic ethanol plant based on switchgrass. The Heller *et al.* paper assumes the production of solid (wood) fuel products. The Schmer *et al.* data are compared with those from Pimentel and Patzek in Tables 3. Since both papers (Schmer *et al.* and Heller, Keolian and Volk) are important to subsequent analysis in this paper, their approach and findings are reviewed briefly here.

5.3. Cellulosic Ethanol from Switchgrass: Schmer et al. 2008

(Bruce Dale) The Schmer *et al.* paper relied on extensive field studies to determine energy inputs and yields for the production of switchgrass, a deep rooted perennial grass native to the American Great Plains. These five year field studies (3–9 ha plots during 2000–2005) were conducted on marginal croplands on ten different farms in the midcontinental U.S. and represented a wide precipitation and temperature gradient. Diesel fuel for field operations and biomass transport to the biorefinery as well as fertilizer nitrogen were found to be by far the dominant energy inputs for switchgrass production, representing about 93% of direct energy inputs. Fertilizer alone accounts for almost half of direct energy inputs.

5.4. Willow for cellulose: Heller et al. 2003

(Bruce Dale) Heller's study used strict life cycle analysis methodologies to evaluate the environmental and energetic performance of willow biomass crop production in the state of New York for electricity generation. The base case analysis was founded on field data from establishment of a 65 ha willow plantation in western NY under current (as of 2000) silvicultural practices in that state. Overall the system produced 55 units of biomass energy output (raw wood) per unit of fossil energy input over a 23 year lifetime of the willow plantation, or an EROI of 55:1 at the farm gate. As with the Schmer *et al.* study described above, fertilizer nitrogen and diesel fuel for farm operations were the largest single energy inputs for willow production according to Heller *et al.* (37% and 46%, respectively of total direct energy inputs, see Figure 3 of their paper) for willow production. EROI for liquid fuel production was not calculated by Heller *et al.*

5.5. Estimates of Energy Costs of Processing Cellulosic Biomass

(Bruce Dale) Cellulosic biomass consists of three major components, cellulose, hemicellulose and lignin, in a roughly 40:30:20 mass ratio, depending on the species, plus a host of other components such as ash, protein, etc. Cellulose and hemicellulose are structural carbohydrates composed of sugars that can be fermented to ethanol, at least potentially. The lignin is a complex aromatic polymer and cannot be fermented using current technology. In practice, not all the sugars in cellulose and hemicellulose are fermented. So at the end of the fermentation the residual material contains the lignin plus the residual carbohydrates that were not successfully fermented. It is often assumed that this residual material will be burned to provide all the electricity and steam required to run the processing facility.

In contrast, Pimentel and Patzek believe that at this time the technology to generate cellulosic ethanol at a commercial scale is quite unproven, and even speculative. They assume that if the cellulosic ethanol technology can be made to scale (which they think is very speculative) then all the energy needed for distillation steam will have to come from fossil fuels [25].

Bruce Dale bases his EROI estimates for cellulosic ethanol from switchgrass on the work of Schmer *et al.*, who, in addition to estimates of the energy used in the field to grow switchgrass, used modeling to explore the crop conversion (biorefining) portion of the system. Schmer's calculations were based on models for the biorefinery and the overall system derived by the Energy and Resources Group Biofuel Analysis Meta-Model (EBAMM, University of California-Berkeley). EBAMM

assumes that all energy used by the biorefinery will come from residual biomass (*i.e.*, that portion not converted to ethanol). This residue is burned to produce electricity and to generate steam to run the biorefinery, *i.e.*, to distill the alcohol from the mash. EBAMM also estimates an electricity export of 4.79 MJ/L of ethanol produced in the biorefinery. Thus Schmer estimates that the overall energy output is 21.2 MJ/L of ethanol plus $(3 \text{ (a factor for the quality of electricity)} \times 4.79 \text{ equals } 14.4) \text{ MJ of electricity}$ for a total of 35.8 MJ/L of ethanol.

To check the EBAMM model, Dale used the Schmer data to calculate the energy used for the agricultural system and the Laser *et al.* [26] modeling information (see Figure 1 in the Laser paper) to describe the conversion (biorefinery) part of the system. Assuming the only energy input to the biorefinery is the energy contained in the biomass, he multiplied the EROI of the agricultural system by the overall thermal energy efficiency of the biorefinery (correcting for electricity quality) and then subtracted the energy costs of biomass transport to the biorefinery to get the system EROI. Figure 1 from the Laser *et al.* paper provides an estimate of 43.3% overall thermal efficiency of conversion of feedstock cellulosic biomass (39.5% ethanol and 3.8% surplus electricity) for mature cellulosic ethanol based on biochemical conversion to ethanol combined with electricity generation. (In effect, this means that 43.3 MJ of useful energy products are derived from 100 MJ of feedstock energy delivered to the biorefinery.) Transport energy was estimated from the Heller *et al* paper as 0.1 kJ per MJ of delivered biomass over a 96 km average transport distance. Using these data, an EROI for cellulosic ethanol from switchgrass is estimated to be 18.1:1, similar to the value of 17.8:1 calculated in Table 3.

There is obviously a substantial difference in the EROI of cellulosic biofuels between Pimentel and Patzek (0.78:1) and Dale (this work) (17.8:1). There are various reasons for this difference. Most importantly, Pimentel and Patzek use 25.5 MJ/L of energy derived from fossil or other outside fuel sources to distill the ethanol from the fermentation residue while Dale assumes that this energy can be derived from the fermentation residue itself. This accounts for 90% ($25.5/27.7$) of the difference in energy costs and correspondingly most of the difference in the EROIs. The second largest difference is that Dale estimates that there will be 4.79 MJ/L of surplus electricity derived from the process. This is based on the assumption that the residual biomass will be enough to not only distill the ethanol but also to generate some residual electricity. This electricity is weighted by a factor of three representing its quality. Thus Dale's overall energy output is 21.2 MJ/L of ethanol plus 14.4 MJ of electricity for a total of 35.6 MJ/L of ethanol. These data for energy inputs and outputs for switchgrass ethanol are summarized in Table 3.

Table 3. Comparing Different EROI Calculations for Switchgrass.

Input (MJ/L ethanol)	Dale (this work)	Pimentel & Patzek
Agriculture		
Fuel	0.19	0.42
Machinery	Not determined	1.22
Fertilizer	0.94	4.18
Pesticides/Herbicides	0.15	0.71
Seeds	Not determined	0.54
Feedstock Transport	0.63	1.07
Estimate for Not Determined items	1.76	0.00
Total including Not Determined	3.77	8.14
Biorefinery		
Water	Not determined	0.23
Fuel	0.00	
Steam	0.00	18.40
Electricity	0.00	7.13
Steel	Not determined	1.08
Misc	Not determined	1.45
Ethanol distribution	0.00	1.39
Total Energy Input to Ethanol	2.01	29.70
Total Energy Output	35.80	21.40
Energy Return on Investment	17.8:1	0.72:1

6. Discussion: Cellulosic Ethanol

6.1. Discussion: Yield of Ethanol per Ton of Biomass

Pimentel believes that since cellulosic biomass, like straw and wood, clearly have very few of the simple starches found in corn, this means that 2 to 3 times more cellulosic material must be produced and processed to obtain a similar amount of cellulosic ethanol as corn (Patzek [27]). Dale responds that corn grain has about 80% carbohydrate (starch), and it is the starch that is converted to ethanol. Switchgrass has about 70% carbohydrate (almost all cellulose and hemicellulose, but very little starch), and these are the carbohydrates that are converted to ethanol. Dale believes that it is incorrect to assert that 2 to 3 times more cellulosic material must be processed to make a similar amount of ethanol. Current ethanol yields from corn grain are about 2.7 gallons per bushel, or approximately 470 L per MG dry grain. Depending on the species used for biomass and conversion technology, current ethanol yields from cellulosic biomass are about 240–350 L per dry MG of biomass ([28-30], with a rough upper limit at about 400 L per dry MG as the technology improves. The upper limit of the current ethanol yield range quoted above (350 L/MG) was obtained by DDCE, LLC (DuPont Danisco Cellulosic Ethanol, LLC) at their 250,000 gallon per year cellulosic ethanol demonstration plant in Vonore, Tennessee [30].

At the yields obtained by DDCE, LLC Dale estimates that it takes about 1.3 tons of cellulosic biomass to provide the same amount of ethanol as a ton of grain, not 2 to 3 times as much, as Pimentel suggests and that eventually it may take only about 10% more cellulosic biomass to provide the same amount of ethanol. Actually, since the residual (unfermented) biomass will be burned to produce electricity, for the sake of a higher EROI we may not want to push the ethanol yield any higher than it is right now. The 3 to 1 multiplier for the quality of the electricity generated from the biomass residual above that required for distillation will push the EROI higher than it would be if more of the carbohydrate were converted to ethanol. The key seems to be getting the right balance of ethanol and electricity to meet our society's needs for both liquid fuels and electricity at sufficiently high EROI.

6.2. Discussion: Potential Scale of Cellulosic Ethanol Industry

While David Pimentel certainly hopes that the proposal to convert cellulosic biomass into liquid fuel will achieve the goal of generating a significant amount of net energy, he is not optimistic that even if this were possible it could make a sufficient difference. Green plants collect and convert less than 0.1% of the incident sunlight into plant matter [12,31,32]. In the United States all green plants collectively produce biomass equivalent to about 53 exajoules of energy per year from sunlight, only about half of our total fossil energy use. Hence even if we were able to use all agricultural, forest, grassland and aquatic plants, with no production of food or fibre, at an impossible 100% efficiency this would be barely enough energy to displace oil. Photovoltaics at 15% efficiency collect 150 times the solar energy per square meter than green plants do per year and would be, in his opinion, a better use of the land.

Bruce Dale responds that the biofuel industry is not trying to replace all energy used in the United States, but only a portion of our liquid fuel, most of which is currently derived from petroleum. He does agree that a high EROI by itself is not sufficient to give us a useful alternative to petroleum—scale also matters. The latest Department of Energy study indicates that around 1.3 billion metric tons of cellulosic biomass can be sustainably produced each year in the U.S. (http://www1.eere.energy.gov/biomass/pdfs/billion_ton_update.pdf). This much biomass is equivalent to about 20 exajoules (or 20 quadrillion BTUs, or 20×10 to the 15th power BTUs), roughly 20% of total U.S. energy consumption). Even if only half of the energy content of biomass can be converted to liquid fuel that would still give us a lot of energy. Relatively simple agricultural changes such as double cropping (growing a winter annual grass following corn) could increase the amount of biofuel produced still further [33] as could increasing the yield of energy crops such as switchgrass and willow.

David Pimentel believes that the DOE claim that 1.3 billion tons of cellulosic biomass can be harvested sustainably cannot possibly be true based on data that he and his graduate students have gathered. This would mean harvesting 72% of total U.S. biomass production per year including all food, grass, and forests. Food crops and grass alone total 92%.

6.3. Discussion: Estimates of Energy Cost of Cellulosic Feedstock Production (Schmer vs. Sampson)

While David Pimentel believes that Schmer's data on costs and gains of switchgrass production are generally believable, he points out that there have been several criticisms of that report [21,22,31,32]. He prefers the assessment of Roger Samson who has more than 15 years of field experience with

switchgrass and has a business producing pelletized switchgrass. Samson *et al.* [21] report that they were able to produce nearly 15 kcal of switchgrass output per 1 kcal of fossil energy input. The main problem David Pimentel has with Schmer *et al.*'s report is their statement that "Switchgrass produced 540% more renewable energy than nonrenewable energy consumed". They achieve this projection by using an extraordinary high estimated yield of ethanol from switchgrass processing of 0.38 L/kg (or 380 L per ton). This is the same yield of ethanol produced from 1 kg of corn grain, a much more fermentable feedstock. Pimentel believes that no one else in the world has achieved even a small portion of the return reported by Schmer *et al.* from switchgrass. Bruce Dale responds that, on the contrary, the current yield of ethanol from corn grain is about 0.47 L/kg of dry corn grain and that many laboratories and commercial operations have already gotten yields approaching 0.35 L/kg of cellulosic biomass, as referenced above. Coauthor Hall wishes to remain neutral in this and other discussions but believe that his coauthors are setting up some very researchable questions for a more mature biofuels industry.

David Pimentel and his collaborator Tad Patzek give several additional arguments about the, in their view, inadvisability of large scale production of fuel from switchgrass in addition to their calculation that it was likely to have an EROI of less than one for one. Patzek in 2010 reported that even if the entire total 140 million hectares of U.S. cropland were planted to switchgrass and converted to ethanol, the gross yield would be only 20% of U.S. gasoline consumption. Also, Smith [34] reported that the cost of producing a liter of ethanol from cellulosic feedstock is €54/L (\$3.09/gal). Bruce Dale responds that the values of switchgrass productivity and ethanol yield assumed by Patzek are unjustifiably low, since we are already able to produce about 10% (by volume) of our gasoline consumption from about one third of our corn grain, which is about one sixth of the total mass of corn grain and corn residue produced on about 36 million hectares of cropland.

Bruce Dale agrees that the Sampson and Schmer data are not that different in terms of the farm level operations. Sampson's data gives an EROI of about 23:1 for solid biomass delivered to the farm gate while the corresponding farm gate EROI for Schmer is about 38:1. (Interestingly, the Heller *et al.* data give an EROI of 55:1 at the farm gate, but that is for wood from trees.) These differences can be reasonably attributed to the different yields and agronomic practices employed in the Sampson study (eastern Canada) versus the Schmer study (midwestern US). As with Schmer, Sampson shows that the energy inputs from the fertilizer and the harvesting operations represent the greatest farm level energy inputs, 58% and 29%, respectively, of the overall energy required to grow, harvest and transport switchgrass to the fuel production facility.

Where Dale and Pimentel disagree strongly is on the ethanol yield from switchgrass. Dale notes that, in fact, DDCE and other firms have already achieved ethanol yields similar to or greater than those used by Schmer. Dale notes that over 100 years ago the Germans developed a wood to ethanol process based on sulfuric acid that achieved about 0.21 L/kg. During World War II, the US used this process to produce cellulosic ethanol for conversion to butadiene to produce synthetic rubber. The Vulcan Copper and Supply Company was contracted to construct and operate a plant to convert sawdust into ethanol. This plant achieved an ethanol yield of about 0.21 L/kg over several years but was not profitable in an era of cheap oil and was closed after the war [35]. Bruce Dale notes that there are a number of smaller (e.g., Mascoma, Gevo, KL Energy, Coskata) and larger (e.g., Shell, BP, DuPont, Chevron, ConocoPhillips) firms that are actively developing cellulosic ethanol and other

biofuels from different materials including corn stover, wheat straw, mixed hardwood chips, sugar cane bagasse, *etc.* [36]. Although process data are generally confidential, these firms are working to increase these yields and seem to be making real progress. Some of them are already operating large demonstration plants. For example, DDCE, a cellulosic ethanol firm owned by DuPont, publicly states that they are achieving 85 gallons per ton (350 L per dry MG or 0.35 L/kg) at their demonstration plant in Vonore, Tennessee [30].

6.4. Discussion: Large Differences in Distillation Energy

Finally, there is a clear difference in opinion on whether or not we will be able to use residuals for fuel for distillation, and this is the main reason that the EROI estimates are so different. Of course because the technology is barely operational at a commercial scale we cannot check which assumption is correct.

Coauthor Dale believes that many different estimates by the National Renewable Energy Laboratory (NREL) and others have shown that more than enough energy is contained in the biomass to run the biorefinery and even have enough left over to export surplus electricity [26,37,38]. The NREL calculations in particular have been extensively vetted by industry and the latest NREL report is coauthored by six practicing engineers from the Harris Group, a large, diversified engineering services and design firm [39]. Also, if the residuals are not burned to provide process heat and electricity, they will have to be disposed of in some way, probably by landfilling. It does not seem reasonable to suppose that industry will not use the ready source of fuel available but will instead opt to pay for its disposal. Furthermore, the Kraft pulp and paper industry is powered largely by its biomass residuals and newer sugar cane to sugar-ethanol-electricity system is completely powered by its residue, sugar cane bagasse, while exporting surplus electricity [40]. Both of these are highly developed, well-established industries. So we have the example of two very large scale industries that show that it is indeed possible to use biomass residuals to provide most or all of the energy needed for biofuel production, presumably including cellulosic biomass.

Pimentel, on the other hand, believes that only some of the residual can be burned. Much of the lignin cannot be extracted and burned. According to the website Lignoworks [41] “Most schemes propose to use the separated lignin as a fuel to run the plant. However, a process that converts all of the input biomass to fuel is unlikely to be economically feasible”. Further support for the statement that only a small portion of the lignin can supply energy comes from specialists in paper production in Alabama [42]. They stated that separating the lignin from the water was too costly in terms of both energy and dollars. What they do is spray the water-lignin mixture into the boilers. They claim only a little net energy from this. The same would be true for cellulosic ethanol production.

Coauthor David Pimentel further states that “There is no evidence that the suggested potential improvements in cellulosic ethanol are possible. Examine the multi-billion dollars that have been spent for the past 5 years with no result.” [43,44]). He also believes that the GREET model is very optimistic, and generates high yield estimates that have not been verified in the field.

6.5. The Possibility for Improved Technology and Increased EROI for Cellulosic Ethanol

The following calculations are intended to illustrate the potential for improvements in cellulosic ethanol's EROI. These calculations assume that the Schmer *et al.* [23] and Heller *et al.* [24] papers are essentially correct in their estimates of the crop production phase energy inputs and that Dale's coauthored paper [26] provides reasonable estimates of the overall energy efficiency of converting biomass to ethanol and electricity, given different conversion technologies.

Dale develops his argument as: "As we have seen from several different sources, by far the dominant energy inputs to agricultural production for both corn and cellulosic biomass are in the nitrogen fertilizer applied and also the diesel fuel used for transport and field operations. Reducing these inputs would therefore increase the EROI for biofuels. Better fertilization practices (slow release fertilizer, precision agriculture), use of leguminous (nitrogen fixing) crops, breeding and genetic modification to reduce fertilizer nitrogen requirements and application of biosolids from waste water treatment instead of synthetic nitrogen fertilizer are all methods by which fertilizer nitrogen inputs might be reduced over time for bioenergy crops such as switchgrass and willow".

Assuming that a future cellulosic ethanol industry is supplied with both switchgrass and willow feedstocks in equal amounts, and that the nitrogen fertilizer inputs for these two materials would be reduced by half from the values given in Table 3, the total nitrogen input would be about 0.33 MJ/L of ethanol. Also, bioenergy crops such as switchgrass and willow are in the very early stages of breeding to increase yields with lower inputs per unit of yield, as has been done so successfully for corn and other crops. For example, fertilizer nitrogen use per bushel of corn has decreased by about one third from 1970 through 2005 [45,46].

Dale believes that significant yield gains and more favorable nitrogen use efficiency can also be expected for cellulosic biomass crops. For example, in 2002 in the Midwestern US, switchgrass required about 120 kg of nitrogen (N) per ha to produce 10.2–12.6 Mg of dry biomass per ha [47]. This is roughly equivalent to 35 MJ of switchgrass produced per MJ of fertilizer N applied (assuming 18 MJ per kg of switchgrass (lower heating value) and 48.2 MJ required to produce 1 kg of N (also lower heating value). The energy requirements of N fertilizer production are based on recent data from the GREET model maintained by Argonne National Laboratory (GREET 1.8d).

In contrast, in 2009, in eastern Tennessee 67 kg of N were required to yield between 15.6–22.9 MG of dry switchgrass per ha on moderately to well drained soils, or around 108 MJ switchgrass produced per MJ of fertilizer N, an increase of about 3 fold versus the earlier Midwestern results of Schmer, *et al* [23]. Obviously, soil type, cultivar and climate all play a role in yield and nitrogen use efficiency, but the point is that very favorable yields and nitrogen use efficiencies leading to potentially high EROI values have already been shown for cellulosic biomass crops. Other increases in efficiency appear possible in agricultural fuel use [49] (and also in the operation of a biorefinery [26]. Table 4 gives Dale's estimates for the improvements in yield and reductions in energy costs for producing switchgrass. If all of these improvements in efficiency are realizable, as Dale thinks possible, then EROI for cellulosic ethanol from switchgrass might be doubled from 17:1 to 35:1. If the thermal efficiency of the biorefinery is increased (e.g., by ethanol and more net electricity produced in a gas turbine combined cycle (GTCC) system [26], then further increases in cellulosic ethanol EROI can be expected.

Table 4. Potential EROI for Advanced Cellulosic Ethanol.

Input (MJ/L ethanol)	Value
Agriculture: Fuel	0.19
Agriculture: Electricity	0.00
Feedstock Transport	0.29
Biorefinery: Fuel	none required
Biorefinery: Electricity	none required
Ethanol Distribution	negligible
Fertilizer	0.33
Pesticides/Herbicides	0.10
Less: Coproduct Energy Input	none
Allocated to Ethanol: Percent	100
Total Energy Input to Ethanol	0.91
Indirect Energy Inputs	0.13
Total Direct + Indirect Inputs	1.04
Total Energy Output	37.10
Energy Return on Investment	35.70

7. Conclusions and Summary

An important objective of this paper has been realized. The coauthors agree that the EROI concept is valuable and can provide important insights about the desirability of particular energy systems. The reasons for the published differences between coauthors Dale and Pimentel with regard to corn ethanol's EROI have been dissected and are shown to be primarily due to allocation issues, not to inherent problems with the underlying concept of EROI. These results highlight the importance of performing EROI using transparent methodologies and allocation approaches, clearly defined system boundaries, and using the best data possible. Lack of crucial data for operating cellulosic ethanol systems makes these EROI calculations inherently more speculative than those for corn ethanol. However, farm level EROI's are relatively high for cellulosic biomass production (ranging from 10:1 to about 50:1 in this analysis). Therefore it is the efficiency of energy conversion in the biorefinery, in particular the practicality of using residual biomass to power the biorefinery, which will determine whether cellulosic ethanol systems can reach the very attractive EROIs that seem possible.

Acknowledgments

The first author greatly appreciates the good will of the second and third author to attempt to deal with their differences in an open and friendly manner through a joint publication. It was not easy for anyone.

Conflict of Interest

The authors declare no conflict of interest.

References and Notes

1. US Energy Information Agency. International Energy Outlook. www.eia.doe.gov/oiaf/ieo/index.html (accessed on 2 December 2011).
2. Oh, W.; Lee, K. Causal relationship between energy consumption and GDP revisited: The case of Korea 1970- 1999. *Energy Econ.* **2004**, *26*, 51-59.
3. Skov, A.M. National health, wealth and energy use. *J. Pet. Technol.* **1999**, *51*, 48-60.
4. Hall, C.A.S.; Klitgaard, K.A. *Energy and the Wealth of Nations: Understanding the Biophysical Economy*; Springer: New York, NY, USA, 2011.
5. US Energy Information Agency. *Short Term Energy Outlook*; US Energy Information Agency: Washington, DC, USA, 2011.
6. Lal, R.; Pimentel, D. Soil erosion: A carbon sink or source? *Science* **2008**, *318*, 1040-1042.
7. Farrell, A.E.; Plevin, R.J.; Turner, B.T.; Jones, A.D.; O'Hare, M.; Kammen, D.M. Ethanol can contribute to energy and environmental goals. *Science* **2006**, *311*, 506-508.
8. Patzek, T. Thermodynamics of the corn-ethanol biofuel cycle. *Crit. Rev. Plant Sci.* **2004**, *23*, 519-567.
9. The conclusions of some of these papers on corn ethanol's EROI have been subject to debate (e.g., see responses to that article in *Science* **2006**, *312*:1746). Kammen, an important contributor to the basically positive view given in Farrell *et al.*, seems to have become less positive as seen in an article in *Time* magazine (7 June 2007).
10. Hammerschlag, R. Ethanol's energy return on investment: A survey of the literature 1990–present. *Environ. Sci. Technol.* **2006**, *40*, 1744-1750.
11. Kim, S.; Dale, B.E. Life cycle assessment of various cropping systems utilized for producing biofuels: Bioethanol and biodiesel. *Biomass Bioenergy* **2005**, *29*, 426-439.
12. Pimentel, D.; Patzek, T. Ethanol production using corn, switchgrass and wood; biodiesel production using soybean. In *Biofuels, Solar and Wind as Renewable Energy Systems: Benefits and Risks*; Pimentel, D., Ed.; Springer Science+Business Media B.V.: Dordrecht, the Netherlands, 2008; pp. 357-394.
13. Murphy, D.J.; Hall, C.A.S.; Dale, M.; Cleveland, C. Order from chaos: A preliminary protocol for determining the EROI of fuels. *Sustainability* **2011**, *3*, 1888-1190.
14. Henshaw, P.; King, C.; Zarnikau, J. System Energy Assessment (SEA), defining a standard measure of EROI for energy businesses as whole systems. *Sustainability* **2011**, *3*, 1908-1943.
15. Stanton, T.L. Feed composition for cattle and sheep. Colorado State University. Cooperative Extension. 1999, Report No. 1.615. 7 pages.
16. International Organization for Standardization (ISO). *International Organization for Standardization 14041: Environmental Management - Life Cycle Assessment - Goal and Scope Definition and Inventory Analysis*; ISO: Geneva, Switzerland, 1998.
17. Szklo, A.; Schaeffer, R. Fuel specification, energy consumption and CO₂ emission in oil refineries. *Energy* **2007**, *32*, 1075-1092.
18. Shapouri, H.; Duffield, J.A.; Wang, M. The energy balance of corn ethanol: An update. Agricultural Economic Report 813, US Department of Agriculture: Washington, DC, USA. 2002.
19. Patzek, T.W. Thermodynamics of the corn-energy biofuel cycle. *Crit. Rev. Plant Sci.* **2004**, *23*, 519-567.

20. Hermans, J.; Reinemann, D. Integrating bio-fuel production with Wisconsin dairy feed requirements. *ASABE J.* 2006, Paper number 066036.
21. Samson, R.; Duxbury, P.; Drisdale, M.; Lapointe, C. Assessment of pelletized Biofuels. PERD Program, Natural Resources Canada, 2000, Contract 23348-8-3145/001SQ.
22. Samson, R.; Duxbury, P.; Mulkins, L. Research and development of fibre crops in cool season regions of Canada. Resource Efficient Agricultural Production-Canada. Box 125, Sainte Anne de Bellevue, Quebec H9X 3V9, Canada, 2004.
23. Schmer, M.R.; Vogel, K.P.; Mitchell, R.B.; Perrin, R.K. Net energy of cellulosic ethanol from switchgrass. *Proc. Natl. Acad. Sci. U. S. A.* **2008**, *105*, 464-469.
24. Heller, M.C.; Keolian, G.A.; Volk, T.A. Life cycle assessment of a willow bioenergy cropping system. *Biomass Bioenergy* **2003**, *25*, 147-165.
25. Arkenol. Our technology. Concentrated acid hydrolysis. <http://www.arkenol.com/Arkenolpercent20Inrech01.html> (accessed on 2 August 2004).
26. Laser, M.; Larson, E.; Dale, B.; Wang, M.; Greene, N.; Lynd, L.R. Comparative analysis of efficiency, environmental impact, and process economics for mature biomass refining scenarios. *Biofuels Bioprod. Biorefin.* **2009**, *3*, 247-270.
27. Patzek, T.W. A probabilistic analysis of the switchgrass ethanol cycle. *Sustainability* **2010**, *2*, 3158-3194.
28. Lau, M.W.; Dale, B. Cellulosic ethanol production from AFEX-treated corn stover using *Saccharomyces cerevisiae* 424A(LNH-ST). *Proc. Natl. Acad. Sci. U. S. A.* **2009**, *6*, 1368-1373.
29. Kazi, F.K.; Fortman, J.A.; Anex, R.P.; Hsu, D.D.; Aden, A.; Dutta, A.; Kothandaraman, G. Techno-economic comparison of process technologies for biochemical ethanol production from corn stover. *Fuel* **2010**, *89*, 520-528.
30. Provine, W. DDCE, Inc. Personal communication, 2011.
31. Pimentel, D.; Patzek, T. Editorial: Green plants, fossil fuels, and now biofuels. *Bioscience* **2006**, *56*, 875.
32. Pimentel, D.; Trager, J.; Palmer, S.; Zhang, J.; Greenfield, B.; Nash, E.; Hartman, K.; Kirshenblatt, D.; Kroeger, A. Energy production from corn, cellulosic, and algae biomass. In *Global Economic and Environmental Aspects of Biofuels*; Pimentel, D., Ed.; Taylor & Francis: Boca Raton, FL, USA, 2012.
33. Dale, B.; Bals, B.; Kim, S.; Eranki, P. Biofuels done right: Land efficient animal feeds enable large environmental and energy benefits. *Environ. Sci. Technol.* **2010**, *44*, 8385-8389.
34. Smith, C.H. When long cycles and depletions interest. 2008. Available online: <http://www.oftwominds.com/blogmay08/cycle-depletion.html> (accessed on 17 August 2011).
35. Katzen, R.; Schell, D.J. Lignocellulosic feedstock Biorefinery: History and plant development for biomass hydrolysis. In *Biorefineries—Industrial processes and Products*; Kamm, B., Gruber, P.R., Kamm, M., Eds.; Wiley-VCH: Weinheim, Germany, 2006; Volume 1, pp. 129-138.
36. Sims, R.E.H.; Mabee, W.; Saddler, J.N.; Taylor, M. An overview of second generation biofuel technologies. *Bioresour. Technol.* **2010**, *101*, 1570-1580.
37. Laser, M.; Jin, H.; Jayawardhana, K.; Dale, B.E.; Lynd, L.R. Projected mature technology scenarios for conversion of cellulosic biomass to ethanol with coproduction of thermochemical fuels, power, and/or animal feed protein. *Biofuels Bioprod. Biorefin.* **2009**, *3*, 231-246.

38. National Renewable Energy Laboratory (NREL). *Enzymatic Hydrolysis: Current and Futuristic Scenarios*; NREL: Golden, CO, USA, 1999; Report NREL/TP-580-26157.
39. Humbird, D.; Davis, R.; Tao, L.; Kinchin, C.; Hsu, D.; Aden, A.; Schoen, P.; Lukas, J.; Olthof, B.; Worley, M.; *et al.* Process Design and Economics for Biochemical Conversion of Lignocellulosic Biomass to Ethanol Dilute-Acid Pretreatment and Enzymatic Hydrolysis of Corn Stover, 2011. Technical Report NREL/TP-5100-47764.
40. Leal, M.R.L.V. Technological evolution of sugarcane processing for ethanol and electric power generation. In *Sugarcane Bioethanol: R&D for Productivity and Sustainability*; Cortez, L.A.B., Ed.; Editora Edgard Blucher Ltda.: São Paulo, SP, Brazil, 2010; pp. 561-582.
41. Lignoworks. What is Lignin? 2011. Available online: www.lignoworks.ca/content/what-lignin (accessed 2 September 2011).
42. Eden, M.R. *et al.* Auburn University. Personal communication, 21 October 2006.
43. Abelard Organization. <http://www.abelard.org/briefings/biofuels.php> (accessed on December 2, 2011).
44. Ratliff, E. One Molecule Could Cure Our Addiction to Oil. *Wired Magazine* **2009**, 15. Available online: www.wired.com/science/planetearth/magazine/15-10/ff_plant? (accessed on December 2 2011).
45. Wang, M. GREET 1.5a—Transportation fuel-cycle model. Argonne National Laboratory, IL, USA. 2000.
46. University of Nebraska-Lincoln. <http://cropwatch.unl.edu/web/cropwatch/archive?articleID=4585476> (accessed on 2 December 2011).
47. Vogel, K.P.; Brejda, J.J.; Walters, D.T.; Buxton, D.R. Switchgrass biomass production in the Midwest USA: Harvest and nitrogen management. *Agron. J.* **2002**, *94*, 413-420.
48. Mooney, D.F.; Roberts, R.K.; English, B.C.; Tyler, D.D.; Larson, J.A. Yield and breakeven price of ‘Alamo’ switchgrass for biofuels in Tennessee. *Agron. J.* **2009**, *101*, 1234-1242.
49. Cook, D.; Shinnars, K. 227 Agricultural Engineering Building, University of Wisconsin-Madison, 460 Henry Mall Madison, WI 53706, USA. Personal communication, 2011.

Article

Energy Return on Investment (EROI) of Oil Shale

Cutler J. Cleveland * and Peter A. O'Connor

Department of Geography and Environment, Boston University, 675 Commonwealth Avenue, Boston, MA 02215, USA; E-Mail: paoconn@bu.edu

* Author to whom correspondence should be addressed; E-Mail: cutler@bu.edu;
Tel.: +1-617-353-7552; Fax: + 1-617-353-5986.

Received: 6 April 2011; in revised form: 4 July 2011 / Accepted: 5 August 2011 /

Published: 22 November 2011

Abstract: The two methods of processing synthetic crude from organic marlstone in demonstration or small-scale commercial status in the U.S. are *in situ* extraction and surface retorting. The considerable uncertainty surrounding the technological characterization, resource characterization, and choice of the system boundary for oil shale operations indicate that oil shale is only a minor net energy producer if one includes internal energy (energy in the shale that is used during the process) as an energy cost. The energy return on investment (EROI) for either of these methods is roughly 1.5:1 for the final fuel product. The inclusions or omission of internal energy is a critical question. If only external energy (energy diverted from the economy to produce the fuel) is considered, EROI appears to be much higher. In comparison, fuels produced from conventional petroleum show overall EROI of approximately 4.5:1. “At the wellhead” EROI is approximately 2:1 for shale oil (again, considering internal energy) and 20:1 for petroleum. The low EROI for oil shale leads to a significant release of greenhouse gases. The large quantities of energy needed to process oil shale, combined with the thermochemistry of the retorting process, produce carbon dioxide and other greenhouse gas emissions. Oil shale unambiguously emits more greenhouse gases than conventional liquid fuels from crude oil feedstocks by a factor of 1.2 to 1.75. Much of the discussion regarding the EROI for oil shale should be regarded as preliminary or speculative due to the very small number of operating facilities that can be assessed.

Keywords: shale oil; EROI; *in situ* production; surface retorting; petroleum

1. Introduction

The vast shale resources of the Western United States have long been known to contain kerogen, a combination of chemical compounds that can be converted into petroleum. A large portion of these resources existed on Federal lands in the early 20th century, and these were set aside as the Naval Petroleum and Oil Shale Reserves. Divestment in the 1980s and 1990s transferred ownership of some oil shale resources to the Northern Ute Indian Tribe, while others were transferred to the Department of the Interior and private ownership.

The kerogen in the shale can be transformed into petroleum through one of two primary processes. In surface retorting, the shale is mined, extracted, and processed. For *in situ* extraction, energy is applied to the shale while it is underground, with the kerogen converted into a liquid synthetic crude oil, pumped out, and refined. Both processes require a considerable amount of direct energy inputs, as well as water, capital and material inputs.

World production of oil from shale was about 684,000 tons in 2005 [1], equivalent to about 5 million barrels, or 13,700 barrels per day. By way of comparison, global crude oil production in 2005 averaged 84.6 million barrels per day. A considerable amount of oil shale is also used as a fuel rather than as a feedstock. Estonia, which has for decades led the world in the production of oil shale, mined 14.6 million tons in 2005. Of this, 10.9 million tons were used for electricity generation.

Interest in oil shale has waxed and waned. During the oil crises of the 1970s, the U.S. Government funded efforts to develop liquid fuels from oil shale. When oil prices dropped in the 1980s, projects were abandoned and companies saw their investments become worthless. Oil prices remained low most of the 1990s. As oil prices began to rise again in the 2000s, some energy companies expressed a modest level of renewed interest in the resource. Two barometers of interest in shale oil—the number of patents filed and the number of publications on the subject—illustrate this history (Figure 1).

Figure 1. Oil Shale R&D [2].

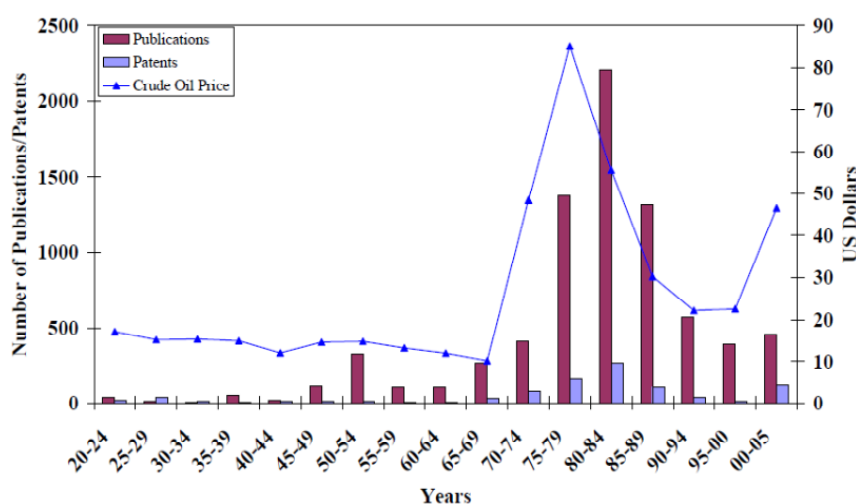

The Energy Policy Act of 2005 included a number of provisions related to the development of shale oil. Among these, the Department of the Interior's Bureau of Land Management (BLM) was to begin leasing its oil shale properties for development. BLM requested proposals in 2005. Winning applicants received leases to develop shale oil research and development projects on BLM properties in the

Western United States; the initial leases were for 640 acres each, with options to expand if the sites and processes proved commercially viable. A 2007 report from the U.S. Department of Energy's Office of Petroleum Reserves, Office of Naval Petroleum and Oil Shale Reserves [3], provides an overview of 27 companies that are major participants in the U.S. shale oil industry, including many of those who had submitted applications through this process. The 2007 report illustrates the fairly limited experience in actual development of oil from shale resources.

The Energy Policy Act also provided for the creation of a Strategic Unconventional Fuels Task Force. In 2007 this Task Force produced a report on the technological and economic aspects of shale oil production [4], but the report did not contain any specific information on the EROI for shale oil.

2. Energy Return on Investment (EROI) Methodology

One technique for evaluating energy systems is net energy analysis, which seeks to compare the amount of energy delivered to society by a technology to the total energy required to find, extract, process, deliver, and otherwise upgrade that energy to a socially useful form. Figure 2 depicts a hypothetical energy system and the types of energy inputs (energy costs) and energy outputs (energy production) associated with that system. Figure 2 could refer to a single oil well or coal mine, a nuclear power plant, a wind farm, or an oil shale facility. The magnitude and timing of the energy production and energy costs are not intended to represent any particular energy system.

Figure 2. The energy cost and energy outputs of a hypothetical energy facility.

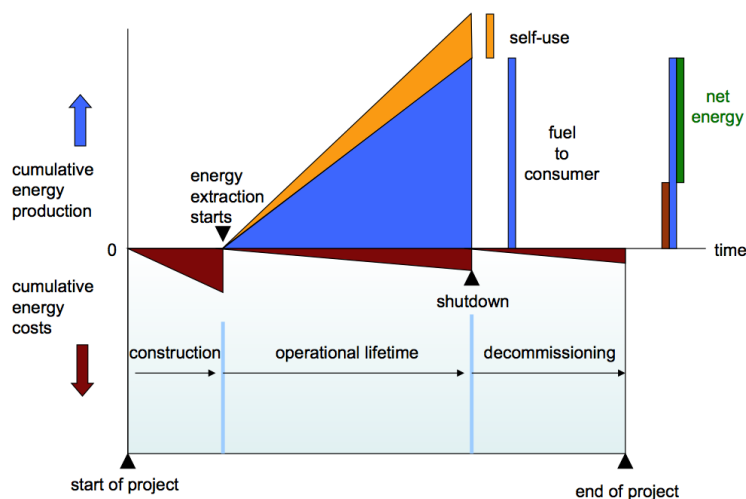

Net energy analysis seeks to assess the direct and indirect energy required to produce a unit of energy. In reference to Figure 2, net energy analysis attempts to quantify all the energy produced and all the energy costs. Energy costs are the sum of direct and indirect energy costs. **Direct energy** is the fuel or electricity used directly in the extraction or generation of a unit of energy. An example is the natural gas burned in engines that pump oil to the surface. **Indirect energy** is the energy used elsewhere in the economy to produce the goods and services used to extract or generate energy. An example is the energy used to manufacture the drilling rig used to find oil. The direct and indirect energy use is called **embodied energy**. Both the energy product and the embodied energy can be

expressed in common physical units of measurement, such as British Thermal Units (BTU) or megajoules (MJ).

Energy return on investment (EROI) is the ratio of energy produced to energy costs. In the case of shale oil, the EROI entails the comparison of the energy content of the fuel produced to the amount of primary energy used in the manufacture, transport, construction, operation, decommissioning, and other stages of the shale oil facility's life cycle. Comparing cumulative energy requirements with the amount of energy the technology produces over its lifetime yields a simple ratio for energy return on investment (EROI):

$$\text{EROI} = (\text{cumulative fuel produced}) / (\text{cumulative primary energy required}) \quad (1)$$

EROI is a dimensionless number. An EROI = 10 means that 10 units of energy are produced for each unit of direct plus indirect energy used in the production process. This is sometimes expressed as “10:1.” An EROI = 1 is an absolute cutoff point for an energy source, the point at which as much energy is used to deliver a unit of energy as that unit yields.

While simple in concept, implementation of net energy analysis requires a number of assumptions regarding the treatment of co-products, the calculation of indirect energy inputs, and in boundary conditions (discussed below). A well-known example of a co-product is “distillers grain” from the fermentation of corn to manufacture ethanol fuel. Drymill ethanol production process uses only the starch portion of the corn, which is about 70% of the kernel. All the remaining nutrients—protein, fat, minerals, and vitamins—are concentrated into distillers grain, a valuable feed for livestock. Should the analysts credit the energy content of the distillers grain as an energy output (or, more accurately, the energy that would have been required to produce feed to replace the distillers grain), and thus include it in the numerator of the EROI for ethanol? Energy analysts debate this point.

These differences account for the well-publicized differences on ethanol EROI, with some studies finding an EROI above 1.0 (a positive net energy) and others finding an EROI below 1.0. See Hammerschlag (2006) [5] or Farrell *et al.* [6] (2006) for a review of the literature and the EROI the various studies have found. Many studies pay little heed to these assumptions, producing confusion when trying to compare results across studies. We return to this issue below in the context of oil shale.

2.1. System Boundary

The choice about system boundaries is perhaps the most important decision made in most in net energy analyses. This often boils down to what extent indirect energy costs are included in the analysis, and how “self energy use” or “internal energy” is accounted for. Some of the analyses in this survey assess only direct energy costs, such as the energy used to heat the shale or to pump fluids. Other studies also include indirect energy in the form of energy embodied in materials and capital equipment, although they vary in the extent and method with which they calculate such costs. Hall and Murphy (2010) [7] categorize the various types of EROI analysis based on their system boundaries. The studies reviewed here would be EROI_{std} or EROI_{1,d}; it is noted in the description of each study whether or not it addresses indirect energy. In several cases, the environmental impacts are quantified, but they are not translated into energy equivalents.

Self-use or internal energy is an important issue in the assessment of the EROI for oil shale. The Shell method of *in situ* retorting of kerogen produces significant quantities of hydrocarbon (HC) gas,

which is burned to generate the electricity used by the process [8]. Similarly, the Alberta Taciuk Processor (ATP) above-ground oil shale retort method produces HC gases and a solid char substance that are burned as fuels. One could argue that these internally generated fuels should not be counted as an energy cost because they do not have an opportunity cost—society did not give something up to create them, unlike the electricity an oil shale facility purchases from the grid. On the other hand, the char or gas generated by the process literally is used up to perform useful work, and thus is a necessary expenditure of energy to produce the desired liquid fuel. This argues for including the self or internal energy in the calculation of the EROI. As Brandt (2008) [8] notes, the internal energy is essential to account for in the assessment of the greenhouse gas emissions from shale oil. Under the EROI Protocol from Murphy and Hall (2010) [7], internal energy consumed is designated I_{rec} , “recycled energy”, and is normally considered in an EROI analysis but not in an External Energy Ratio (EER) analysis.

Energy systems have external costs as well, most notably environmental and human health costs, although these are sometimes more difficult to assess in energy terms. Energy systems also require inputs that are difficult to quantify in energy terms, such as the use of land and water. The shale oil system, for example, requires significant inputs of water and releases solid waste and greenhouse gases. Mulder and Hagens (2008) [9] argue for the use of a multicriteria EROI in which additional metrics are added to the analysis, such as energy yield per unit land or per unit water consumed.

2.2. Shale Oil Conversion Technology

The two main processing options for shale oil are surface retorting and *in situ* extraction. In surface retorting, the shale is mined and brought to the surface, with the material then heated in a retort to extract the compounds that are processed into synthetic crude oil (Figure 3). *In situ* extraction involves heating the material underground and pumping liquids to the surface, where they then undergo further processing. Shell conducted research on an *in situ* extraction at its Mahogany Research Project, in Rio Blanco County, Colorado. The small number and small scale of existing facilities limits the assessments that can be done. These and a few other projects form the basis of most recent analyses.

Figure 3. Shale oil conversion processes [10].

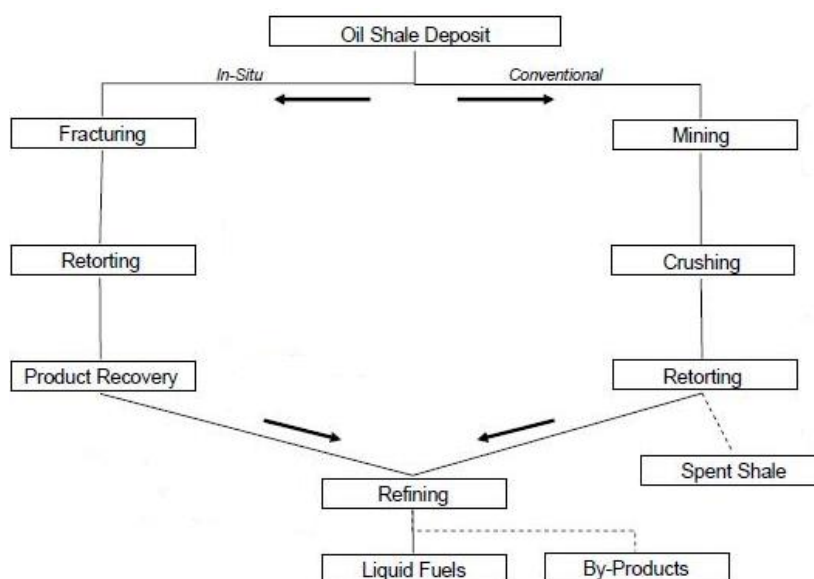

3. Review of Existing Studies

Table 1 summarizes the existing studies that report data on the EROI for oil shale. Note that these studies vary widely in their scope, method of assessment, and the degree to which the veracity of their conclusions can be objectively assessed. We exclude most references to the EROI for oil shale that lacked sufficient explanation of assumptions and methods. We also exclude studies prior to 2000 because they reflect technologies and resource assessments that are outdated and/or inaccurate.

Table 1. Summary results of the energy, carbon and water costs associated with oil shale.

Authors	Process	EROI	kg CO ₂ per bbl	Water (bbl per bbl oil)	Scope	Notes
Bartis <i>et al.</i> (2005) [11]	<i>In situ</i>	2 to 4 electric; 6 to 7 thermal	“significantly higher” than conventional oil	3	Heating Energy	Electricity demand of 250-300 kWh per bbl of oil; regards down-hole gas burning as speculative
DOE (2007) [12]	<i>In situ</i> electric; <i>in situ</i> thermal; surface	2.5; 6.9 >10	“large quantities”; “may need to be captured”	–	Heating and Mechanical Energy	Fact Sheets (citing unspecified Bunger 2006 work for EROI)
Bunger <i>et al.</i> (2004) [10]	surface retorting (ATP)	“energy self-sufficient” for heating	“higher” than conventional petroleum	“may still be a constraining factor”	Heating and Mechanical Energy	
Brandt (2008) [7]	<i>In situ</i> electric, on-site CCGT from co-produced gas	2.4–15.8 (external) 1.2–1.6 (net)	30.6–37.1 g C per MJ of refined fuel delivered → ~600–730 kg CO ₂ per bbl of refined fuel produced	–	Simplified process-model LCA; energy and material inputs	Fugitive emissions included; output is compared to average of diesel and gasoline
Brandt (2009) [13]	Surface retorting (ATP), shale char is principal energy source	2.6–6.9 (external) 1.1–1.8 (net)	129-153 g CO ₂ per MJ of reformulated gasoline → ~660–780 kg CO ₂ per bbl of gasoline	–	Process-model LCA; energy and material inputs	Fugitive emissions not included; output is compared to reformulated gasoline
Backer and Duff <i>et al.</i> (2007) [14]	Surface retorting;	3	-	1 to 3	Unspecified	
House Committee on Resources (2005) [15]	<i>In situ</i> electric; <i>In situ</i> thermal	3 6	“likely to be substantially higher” than conventional petroleum production.	1 to 2	Heating energy	Principal Deputy Assistant Secretary for Fossil Energy, based on Shell data

3.1. Brandt (2008) [8] and (2009) [13]

The most authoritative work on the energy and carbon balance of oil shale is by Brandt (2008, 2009) [8,13] in which he models current technologies for *in situ* and surface oil shale operations. Brandt’s analysis defines two different measures of EROI based on a distinction between what he calls “external energy” and “net energy.” The external energy ratio (EER) compares the energy produced to the direct and indirect energy purchased by the oil shale facility. This method excludes the internal or self energy use as an “energy cost”.

The net energy ratio (NER) includes purchased energy plus primary energy input from the feedstock resource itself (e.g., coproduced HC gas consumed for electricity generation). That is, the NER approach counts self or internal energy as an energy cost of producing liquid fuel.

Brandt (2008) [8] models the Shell *in situ* conversion process that utilizes electricity to heat the underground shale over a period of two years. Hydrocarbons are produced using conventional oil production techniques. The Shell process co-produces HC gas that powers a combined-cycle gas turbine, which in turn meets some of the project's electricity needs. External energy is needed for construction, drilling, refining, and product transport, and possibly as supplemental heating power.

The resulting External Energy Ratio ranges from 2.4–15.8:1, depending on assumptions. The Net Energy Ratio, which takes into account the internal energy consumed, is much lower, in the range of 1.2–1.6:1.

The resulting greenhouse gas emissions are projected to be about 20–50% higher than those of conventional oil (range of 30.6 to 37.1 grams C per megajoule (MJ) of fuel, compared to 25.3 for the average of gasoline and diesel). These values are comparable to oil sands (29–36) and lower than those of coal-derived liquids (42–49). This analysis does include fugitive greenhouse gas emissions.

Brandt (2009) [13] assesses the surface retorting method for producing liquid fuel from Green River oil shale using the Alberta Taciuk Processor (ATP). The ATP is an above-ground oil shale retort method that combusts the coke or “char” deposited on the shale during retorting to fuel the retorting process. As with the *in situ* method, much of the energy input comes from the shale itself. Mining and refining account for about 1/3 of the overall energy demand; the energy used to operate the retort accounts for most of the remainder. Mining and refining are major external energy demands, and in some cases use external electric power for the retort. Systems that generate on-site using co-produced natural gas will count electricity as internal.

The External Energy Ratio ranges from 2.6–6.9:1. The lower range of uncertainty compared to the *in situ* method is probably due to the greater experience with actual systems. Variations in mining energy requirements and upgrading energy requirements account for more than half of the variation between the “low” and “high” cases. The Net Energy Ratio ranges from 1.1–1.8:1. Energy requirements for materials such as steel and cement are included in this analysis, though the magnitude of this impact is relatively small according to the study's supporting materials.

Brandt (2009) [13] conservatively estimates that the resulting greenhouse gas emissions are about 50–75% higher than those of conventional oil, and that is without considering fugitive emissions.

3.2. The RAND Study (Bartis et al. 2005) [11]

This study provides an overview of the land use, conventional pollutants, greenhouse gas emissions, water quality, and water consumption associated with oil shale development. The RAND report is not a specialized EROI analysis *per se*, and it does not contain a full calculation of indirect energy inputs or a quantitative assessment of all externalities. However, it does provide data on certain direct energy inputs, as well as a qualitative description of externalities.

The report provides a detailed description of both surface retorting and *in situ* extraction technologies. Surface retorting involves crushing the oil shale and heating it to approximately 500 °C for over half an hour. The report also mentions the challenges encountered by the Unocal plant in the Piceance Basin, which closed in 1991 after producing at only half of its design output. Exxon's surface

retorting Colony project was abandoned before completion. International experience in Estonia, China, Brazil, and Russia is seen as not illustrative for U.S. applications due to the plants' size and regulatory conditions.

The primary *in situ* process considered is the thermally conductive *in situ* extraction process demonstrated by Shell. This involves slowly heating the shale to a lower temperature (approximately 350 °C) over a period of three years. Fluids (oil and gas) are then pumped out of the formation. The principal direct energy inputs are the electricity used to heat the shale and the energy used to create the "freeze wall" that protects the local groundwater and prevents the valuable hydrocarbons from escaping the project boundaries.

The report states that "the heating energy required for this process equals about one-sixth the energy value of the extracted product." This by itself would suggest an $EROI_{\text{therm}}$ of 6:1, but as noted, there are additional energy demands for the freeze wall, and indirect energy inputs in materials and capital. More importantly, the heating energy is electricity that must be generated by burning a fuel. Specifically, the energy inputs are 250–300 kWh per barrel of extracted product. A value of 300 kWh equals about 1 GJ, and a barrel of oil contains about 6 GJ. However, if the electricity was produced from coal converted at an efficiency of 40%, then the actual primary energy inputs are 2.5 times as great as the nominal heating energy, or 2.5 GJ. Thus, the $EROI_{\text{elec}}$ would be 2.4:1. The size of a generating plant would be considerable, accounting for a significant share of the water demands. An *in situ* process capable of producing 100,000 barrels per day would require a generating capacity of 1.2 GW. Along with EROI impacts, the use of coal for generation would produce a significant greenhouse gas impact. Every 6 GJ of synthetic crude would produce, in addition to the emissions from its own combustion, the emissions from 2.5 GJ of coal. Another fuel source that might be utilized is the natural gas that is co-produced with shale oil; however, this would carry a higher cost.

Water consumption is specified as about three barrels of water per barrel of oil produced. RAND notes that earlier studies found water as a limiting factor for shale oil development.

3.3. *Bunger et al. (2004) [10]*

Bunger *et al.* (2004) [10] authored a report for the Department of Energy entitled "Strategic Significance of America's Oil Shale Resource." Volume 2 of this report focused on the economic and technological aspects of oil shale development. This report characterizes the processing of oil shale through the Alberta Taciuk Processor (a surface retort) as "energy self-sufficient" for the purposes of heating. This means that the combustion of some of the compounds present in the shale provide the thermal energy required to extract the remaining compounds. External energy inputs (electricity) are only required for mechanical energy in the process, and amount to about 12–15 kWh per metric ton of ore. At 25 gallons of synthetic crude per ton, and a heat rate of 10,000 BTU per kWh (34% generation efficiency), this would be about 5% of the energy content in the shale. However, that does not include energy for mining and ore transport.

Bunger *et al.* (2004) [10] is not a specialized EROI analysis *per se*, and it does not contain a full calculation of indirect energy inputs or a quantitative assessment of all externalities. It also does not discuss the energy inputs required for *in situ* shale oil production. It provides a qualitative discussion of environmental impacts, with particular attention to how these compare to the impacts of production of petroleum from oil sands.

A subsequent Department of Energy fact sheet on the EROI of various unconventional oil resources cited Bungler's work to provide a value of over 10:1 for surface retorting, roughly 7:1 for non-electric heating *in situ* extraction, and 2.5:1 for electric heating *in situ* extraction (DOE, 2007) [12]. The fact sheet provides no methodological detail, so it is impossible to judge the veracity of its conclusions. It appears to consider only the external energy supplied to the process—the energy used for electricity generation for electric heating is excluded, as are indirect energy costs. Thus, the EROI reported in the DOE fact sheet is certainly too high, although the margin of error is impossible to ascertain due to the lack of documentation.

3.4. Backer and Duff et al. (2007) [14]

“Peak Oil Production and the Implications to the State of Connecticut” was submitted to Connecticut's legislative leaders and Governor in November 2007 by the Legislative Peak Oil and Natural Gas Caucus. The lead members were Representative Terry Backer and Senator Bob Duff, with support from Paul Sankowski and Steve Andrews. A December 2007 addendum on tar sands and shale oil also assessed the impacts of these resources. The report also cites EROI of 3:1 for surface retorting, though not specifying a source. There is no documentation for this result, so little confidence can be placed in its accuracy. Water demand is stated as one to three barrels of water per barrel of oil for industrial operations. The municipal and industrial growth required to support the production of 2.5 million barrels per day would require another 50 million gallons per day, in addition to the 100–300 million gallons of industrial water demand. The long timeframe for power plant construction is noted as a hurdle to development, and the water-related issues are given particular attention.

3.5. House Committee on Resources (2005) [15]

The House of Representatives Committee on Natural Resources held hearings on the oil shale resource in June 2005. One of the speakers was Jack Savage, President and CEO of Oil-Tech, Inc. This company produced shale oil in a surface retorting process at a small facility in Utah. Mr. Savage discussed the operation, including the thermal energy self-sufficiency of the process. Mr. Savage also described his company's operations as requiring relatively low capital investment, which would argue for low indirect energy inputs in materials.

The representative from Shell, Mr. Terry O'Connor, discussed *in situ* production. Some specific practical challenges were identified, such as developing heaters that would last for the multi-year duration of the process.

Mark Maddox, Principal Deputy Assistant Secretary of Energy for Fossil Energy, answered a number of questions on shale oil. Citing Shell's work, he quoted an EROI value of 3:1 for *in situ* extraction, or 6:1 if the natural gas co-produced with the shale oil is used to provide the necessary heat. Mr. Maddox notes the connection between EROI and greenhouse gas emissions for shale oil development. Mr. Maddox also noted an additional source of CO₂ emissions: beyond that from the combustion of the shale oil and that of the energy used for heating, some process CO₂ emissions result when the carbonate compounds in the shale are heated in a retort. Finally, Maddox cites a figure of 1 to 2 barrels of water per barrel of oil produced.

The wording of Mr. Maddox's response to the energy balance question suggests that the answer refers to direct energy consumption. The values cited line up with the downhole heating energy demands in the RAND study, which are "one-sixth the energy value of the extracted product," or a 6:1 EROI if natural gas provides the heat. With 50% efficient generation, the EROI would be 3:1 for electric heating *in situ* production. Other indirect energy costs and indirect energy costs are excluded.

3.6. Cleveland (2005) [16]

Cleveland (2005) [16] offers an extensive discussion of EROI methodology. The values reported for the EROI for oil shale are above and below the break-even point, with the median estimate around 5:1 or less. These findings are based on Cleveland *et al.* (1984) [15], which assessed the EROI of a range of energy resources based on the then-current literature. The studies referenced by Cleveland *et al.* (1984) [17] via Lind and Mitsch (1981) [18] date from the mid-1970s. They show EROI ranging from 0.7:1 to 13.3:1. This wide range is partly due to very limited experience with actual projects, and partly due to the less-developed state of EROI analysis at the time. The range cited by Cleveland (2005) [16], based as it is on these earlier studies, is not representative of the current state of technology and resource assessment.

3.7. Burnham et al. (2010) [19]

American Shale Oil LLC (AMSO) has proposed a new method of producing oil shale from the source rock. This method relies on heating an illitic shale layer under pressure to fracture it, increase permeability, and perform *in situ* retorting, while a nahcolitic shale oil layer above serves to insulate the producing layer from groundwater. The process is still under development and has not yet been field-tested. AMSO projects water consumption of less than one barrel per barrel of oil produced, CO₂ emissions from downhole heating of 50 kg per barrel of oil (roughly 10% of the CO₂ from burning that oil), and an EROI of possibly 5:1 (considering all energy uses) to 8:1 (considering direct energy only).

3.8. Bunger and Russell (2010) [20]

Bunger and Russell (2010) [20] analyze the thermal efficiency of shale oil production, modeling a surface retort. The study notes the increasing energy cost of petroleum recovery, and states that shale oil production will soon be "thermodynamically competitive" with petroleum. Bunger and Russell use an "efficiency of conversion" approach, where the energy required for each step gives an efficiency value for that point in the process. For example, mining and ore preparation require approximately 4% of the energy content in the shale (96% efficiency), while upgrading requires about 2.5% of the energy in the feedstock (97.5% efficiency). The analysis also notes that the internal energy consumed has no other economic use. The overall energy efficiency is seen to be 81%, corresponding to an EROI of 5.3:1. That is, if $E_f/E_0 = 0.81$, then $E_f/(E_0 - E_f) = 5.3$. The analysis does not include embodied energy in materials or other indirect energy. Direct energy is considered, as is the energy required for electricity generation (40% generation efficiency is assumed).

4. Comparison with Conventional Oil Production

Most of the world's liquid fuels are derived from conventional extraction and processing of crude oil. How does the EROI for shale oil compare with that for conventional oil? Delucchi (1991 [21], 1993 [22], 2003 [23]) estimates the amount of energy used in various fuel cycles related to the use of alternative transportation fuels. This work is used in the GREET (Greenhouse gases, Regulated Emissions, and Energy use in Transportation) model sponsored by the Argonne National Laboratory. GREET evaluates the fuel cycle from well to wheel and for various fuel and vehicle technologies. Delucchi's (1991) [21] data indicate an EROI of about 43:1 for crude oil at the wellhead that is destined to be refined into motor gasoline (Figure 4). Delucchi's (2003) [23] revisions project an EROI of about 20:1 for crude oil at the wellhead by 2015. The decline from 43:1 to 20:1 from 1991 to 2015 is due in part to Delucchi's assumption that an increasing share of production will come from energy-intensive offshore drilling, heavy oil, and enhanced recovery.

Figure 4. A comparison of estimates of the energy return on investment (EROI) at the wellhead for conventional crude oil, or for crude product prior to refining for shale oil.

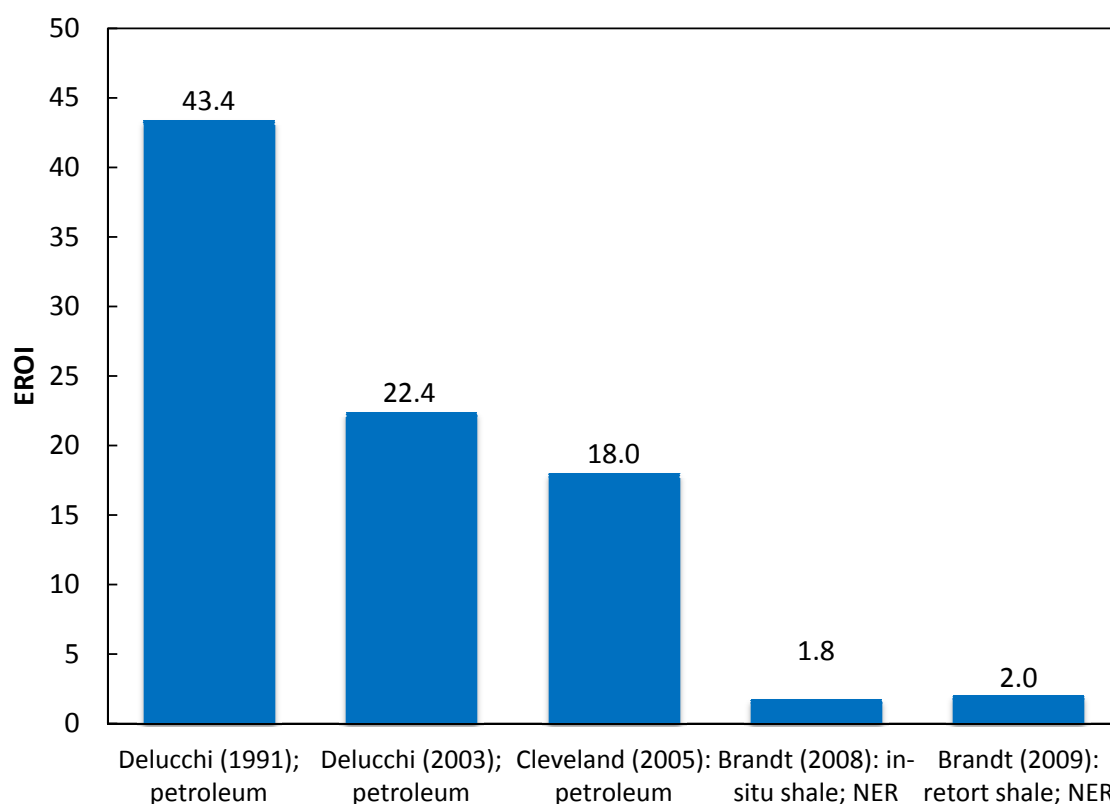

Cleveland (2005) [16] uses a different methodology to estimate an EROI for oil and gas production at the wellhead of about 23:1 in 1997. This figure is based on direct fuel and electricity costs only, and is the return to the sum of oil plus gas produced-no attempt is made to allocate joint energy costs separately to oil and gas. Cleveland estimates the EROI for oil and gas production to be about 18:1 in 1997 when direct plus indirect energy costs are included. Cleveland's estimates of EROI are lower

than Delucchi's (1991) [21] because his method uses a much more comprehensive definition of indirect energy use.

Brandt's work [8,13] can be used as the basis for calculating the EROI for shale oil at a stage of processing similar to crude oil at the wellhead. Both the *in situ* and surface retorting methods produce a "crude" product that must be refined into a useful fuel. Brandt's data indicate an EROI of around 2:1 for the extraction of the crude product from the shale (Figure 4). The estimates in Figure 4 are the average of Brandt's "high" and "low" scenarios prior to the energy costs of refining.

We can also compare these two technologies at the refining stage (Figure 5). Here the EROI is the energy content of the refined fuel compared to the energy required to extract, process, and refine the crude product into a finished fuel that is ready for end use. Delucchi's (1991, 2003) [21,23] work suggests an EROI of about 4.7 for motor gasoline refined from conventional crude oil. Brandt's (2008, 2009) [8,13] indicates an EROI of about 1.4 for liquid fuel refined from shale oil.

Figure 5. A comparison of estimates of the energy return on investment (EROI) for refined fuel produced from conventional crude oil and from shale oil.

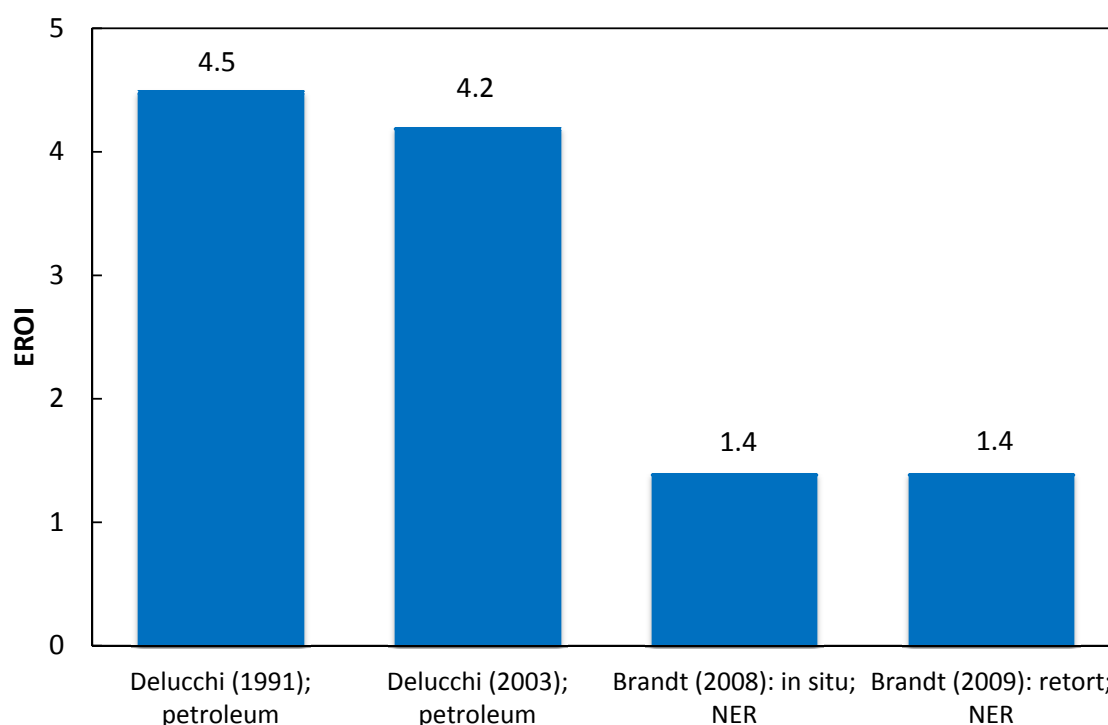

The drop in EROI from the wellhead to the pump seems very large for refined petroleum because EROI is a ratio. Delucchi (1991) [21], Table 3, indicates that for every 100 MJ of reformulated gasoline sold to a consumer, roughly 2.5 MJ are expended in extracting the crude, 1.2 MJ in transporting the crude, 18.5 MJ in refining it, and 0.8 MJ in distributing it. For the 2003 revision, the costs are 4.8 MJ for extraction, 1.1 MJ for transport, 17.0 MJ for refining, and 0.95 MJ for distribution. The refining costs for shale oil are not greatly different (around 11 MJ for *in situ* or 15 MJ for surface retorting), but because EROI is already so low, the costs have a lesser impact on the EROI for shale oil.

An added energy cost equal to 15% of final energy will reduce an EROI of 40 down to 5.7, but it will only reduce an EROI of 4 down to 2.5.

5. Conclusions

The discussion surrounding the net energy balance of shale oil is characterized by data and conclusions that lack rigorous analysis and review. Among those studies that apply some type of formal analysis, most focus on the assessment of a portion of direct energy use, ignoring other direct energy use and indirect energy use.

By a wide margin, Brandt's (2008, 2009) [8,13] are the most credible studies. Brandt's work suggests that the EROI for oil shale falls between 1:1 and 2:1 when internal or self-use energy is included as an energy cost. This choice of system boundary is consistent with method used to calculate the EROI for conventional oil and coal extraction (Cleveland, 2005) [16]. In the case of conventional oil extraction, for example, considerable co-produced natural gas is burned as a fuel to power field operations. Cleveland (2005) [16] includes so called "captive" fuel use as an energy cost of oil because it is energy that is literally used up to produce oil. The gaseous and char fuels generated and then burned in the oil shale production process should be viewed in the same way. As noted above, however, one could argue that these fuels should not be counted as an energy cost because they do not have an economic opportunity cost. Of course, the environmental impact from the combustion of those fuels occurs regardless of the accounting scheme.

This places the EROI for shale oil considerably below the EROI for conventional crude oil. This conclusion holds for both the crude product and refined fuel stages of processing. Even in its depleted state—smaller and deeper fields, depleted natural drive mechanisms, *etc.*—conventional crude oil generates a significantly larger energy surplus than shale oil. This is not a surprising result considering the nature of the natural resource exploited in each process. The kerogen in oil shale is solid organic material that has not been subject to the temperature, pressure, and other geologic conditions required to convert it to liquid form. In effect, humans must supply the additional energy required to "upgrade" the oil shale resource to the functional equivalent of conventional crude oil. This extra effort carries a large energy penalty, producing a much lower EROI for oil shale.

There remains considerable uncertainty surrounding the technological characterization, resource characterization, and choice of the system boundary for oil shale operations. Even the most thorough analyses (Brandt, 2008, 2009) [8,13] exclude some energy costs. Based on Brandt's analysis, it is likely that oil shale is still a net energy producer, but it does not appear to carry a large energy surplus.

An important caveat is in order here: the EROI of 1–2 reported by Brandt includes self energy use, *i.e.*, energy released by the oil shale conversion process that is used to power that operation. For example, most of the retorting energy in the ATP process is provided by the combustion of char and produced gas, significantly reducing energy needs *from the point of view of the operator*. From a net energy perspective, how should this internal use of energy be treated? The answer depends on the question being asked. One could argue that the char and gas produced and consumed within the shale conversion process has zero opportunity cost—*i.e.*, that energy would not, or could not, be used somewhere else in the economy, so it should not be treated as a "cost." The EROI calculated using this perspective is in the range of 2 to 16. On the other hand, the internal energy is an essential expenditure

of work necessary to produce the liquid fuel. The internal energy is absolutely necessary to accurately assess greenhouse gas emissions.

Another issue is energy quality. Society willingly sacrifices 3 BTUs of coal to generate 1 BTU of electricity in thermal power plants. This makes economic sense because a BTU of electricity is more valuable than a BTU of coal. Oil shale operations consume large quantities of electricity to upgrade a low quality resource (oil shale) to a higher quality form (liquid fuel). But liquid fuel is still a lower quality form of energy than electricity, at least from a macroeconomic perspective. Accounting for these differences can dramatically alter the results of EROI analyses (Cleveland, 1992) [24]. The Shell *in situ* process is very electricity-intensive, and accounting for energy quality would, *ceteris paribus*, lower the reported EROI. Note, however, that one could argue against accounting for quality because if that electricity is self-generated, it may have zero opportunity cost. Future work should address these issues.

The low EROI for oil shale is closely connected to a significant release of greenhouse gases. The large quantities of energy needed to process oil shale, combined with the thermochemistry of the retorting process, produce carbon dioxide and other greenhouse gas emissions. Oil shale unambiguously emits more greenhouse gases than conventional liquid fuels from crude oil feedstocks by a factor of 1.2 to 1.75 (Brandt, 2008, 2009) [8,13]. Brandt (2010) [25] provides greater discussion of CO₂ emissions from oil shale, including those from carbonate decomposition.

A fuel with a modest EROI that emitted few greenhouse gases could at least be a candidate for an alternative source of energy. However, a very low EROI combined with a very high carbon intensity should remove an energy system from serious consideration as an alternative to conventional crude oil extraction and refining. Oil shale in the western United States appears to fall into this category. Generally speaking, a fuel with high EROI and high carbon emissions per unit of net energy delivered, such as coal, enables a considerable expansion of economic activity at the cost of environmental impact. A fuel with low EROI but relatively low carbon emissions per unit of net energy delivered does not allow much expansion of economic activity, but has a reduced adverse effect on climate. A fuel that has both low EROI and high carbon emissions offers neither the potential for economic gain nor the potential of mitigating environmental impact.

References and Notes

1. Dyni, J.R. Oil Shale. In *2007 Survey of Energy Resources*; Clarke, A.W., Trinnaman, J.A., Eds.; World Energy Council: London, UK, 2007; pp. 93-118.
2. Smith, M.W.; Shadle, L.J.; Hill, D.L. *Oil Shale Development from the Perspective of NETL's Unconventional Oil Resource Depository*. Presentation at 26th Oil Shale Symposium, Golden, CO 18 October, 2006.
3. Crawford, P.M.; Knaus, E. *Secure Fuels from Domestic Resources: The Continuing Evolution of America's Oil Shale and Tar Sands Industries (Profiles of Companies Engaged in Domestic Oil Shale and Tar Sands Resource and Technology Development)*; U.S. Department of Energy: Washington, DC, USA, 2007.
4. U.S. Department of Energy, Strategic Unconventional Fuels Task Force. *Development of America's Strategic Unconventional Fuels*; U.S. Department of Energy: Washington, DC, USA, 2007.

5. Hammerschlag, R. Ethanol's energy return on investment: A survey of the literature 1990-present. *Environ. Sci. Technol.* **2006**, *40*, 1744-1750.
6. Farrell, A.; Plevin, R.J.; Turner, B.T.; Jones, A.D; O'Hare, M.; Kammen, D.M. Ethanol can contribute to energy and environmental goals. *Science* **2006**, *311*, 506-508.
7. Murphy, D.J.; Hall, C.A.S.; Cleveland, C. Order from Chaos: A preliminary protocol for determining EROI of fuels. *Sustainability* **2011**, *3*, 1888-1907.
8. Brandt, A. Converting oil shale to liquid fuels: Energy inputs and greenhouse gas emissions of the shell *in situ* conversion process. *Environ. Sci. Technol.* **2008**, *42*, 7489-7495.
9. Mulder, K.; Hagens, N.J. Energy return on investment: Toward a consistent framework. *Ambio* **2008**, *37*, 74-79.
10. Bunger, J.W.; Johnson, H.R.; Crawford, P.M. *Strategic Significance of America's Oil Shale Resource, Volume II: Oil Shale Resources Technology and Economics*; U.S. Department of Energy: Washington, DC, USA, 2004.
11. Bartis, J.T.; LaTourrette, T.; Dixon, L.; Peterson, D.J.; Cecchine, G. *Oil Shale Development in the United States: Prospects and Policy Issues*; RAND Corporation: Santa Monica, CA, USA, 2005.
12. U.S. Department of Energy. *Fact Sheet: Energy Efficiency of Strategic Unconventional Resources*; U.S. Department of Energy: Washington, DC, USA, 2007.
13. Brandt, A. Converting oil shale to liquid fuels with the alberta taciuk processor: Energy inputs and greenhouse gas emissions. *Energ. Fuel.* **2009**, *23*, 6253-6258.
14. Backer, T.; Duff, B. *Peak Oil Production and the Implications to the State of Connecticut: Report of Legislative Peak Oil and Natural Gas Caucus*; Connecticut General Assembly: Hartford, CT, USA, 2007.
15. U.S. House of Representatives. *The Vast North American Resource Potential Of Oil Shale, Oil Sands, And Heavy Oils, Parts 1 And 2: Oversight Hearings Before The Subcommittee On Energy And Mineral Resources Of The Committee On Resources, U.S. House Of Representatives, One Hundred Ninth Congress, First Session, 23 and 30 June, 2005*; U.S. House of Representatives: Washington, DC, USA, 2005.
16. Cleveland, C.J. Net energy from the extraction of oil and gas in the United States 1954–1997. *Energy* **2005**, *30*, 769-782.
17. Cleveland, C.J; Costanza, R; Hall, C.A.S.; Kaufmann, R. Energy and the U.S. economy: A biophysical perspective. *Sci. New Ser.* **1984**, *225*, 890-897.
18. Lind, C.G.; Mitsch, W.J. A net energy analysis including environmental cost of oil shale development in Kentucky. In *Energy and Ecological Modelling*; Mitsch, W.J., Bosserman, R.W., Klopatek, J.M., Eds.; Elsevier Scientific: New York, NY, USA, 1981; pp. 689-696.
19. Burnham, A.K.; Day, R.L.; Hardy, M.P.; Wallman, P.H. AMSO's Novel Approach to *in situ* oil shale recovery. In *Oil Shale: A Solution to the Liquid Fuel Dilemma*; Ogunsola, O.I., Hartstein, A.M., Ogunsola, O., Eds.; Oxford University Press: New York, NY, USA, 2010; pp. 149-160.
20. Bunger, J.W.; Russell, C.P. Thermodynamics of Shale Oil Production. In *Oil Shale: A Solution to the Liquid Fuel Dilemma*; Ogunsola, O.I., Hartstein, A.M., Ogunsola, O., Eds.; Oxford University Press: New York, NY, USA, 2010; pp. 89-101.

21. Delucchi, M.A. *Emissions of Greenhouse Gases from the Use of Transportation Fuels and Electricity, Volume 1: Summary*; Center for Transportation Research, Argonne National Laboratory: Argonne, IL, USA, 1991.
22. Delucchi, M.A. *Emissions of Greenhouse Gases from the Use of Transportation Fuels and Electricity, Volume 2: Appendices*; Center for Transportation Research, Argonne National Laboratory: Argonne, IL, USA, 1993.
23. Delucchi, M.A. *A Lifecycle Emissions Model (LEM): Lifecycle Emissions from Transportation Fuels, Motor Vehicles, Transportation Modes, Electricity Use, Heating and Cooking Fuels, and Materials, Documentation of methods and data*; University of California at Davis: Davis, CA, USA, 2003.
24. Cleveland, C.J. Energy quality and energy surplus in the extraction of fossil fuels in the U.S. *Ecol. Econ.* **1992**, *6*, 139-162.
25. Brandt, A.R.; Boak, J.; Burnham, A.K. Carbon dioxide emissions from oil shale derived liquid fuels. In *Oil Shale: A Solution to the Liquid Fuels Dilemma*; Ogunsola, O., Ed.; ACS Symposium Series 1032. American Chemical Society: Washington, DC, USA, 2010.

© 2011 by the authors; licensee MDPI, Basel, Switzerland. This article is an open access article distributed under the terms and conditions of the Creative Commons Attribution license (<http://creativecommons.org/licenses/by/3.0/>).

Article

An Edible Energy Return on Investment (EEROI) Analysis of Wheat and Rice in Pakistan

Ali S. Pracha ^{1,*} and Timothy A. Volk ²

¹ Centre for Policy and Environment (CPE), Lahore School of Economics (LSE), Main Campus, Intersection Main Boulevard Phase VI DHA and Burki Rd., Burki 53200, Lahore, Pakistan

² Department of Forestry and Natural Resources Management, State University of New York, College of Environmental Science and Forestry (SUNY ESF), 1 Forestry Drive, Syracuse, NY 13210, USA; E-Mail: tavolk@esf.edu

* Author to whom correspondence should be addressed; E-Mail: aspracha@lahoreschool.edu.pk; Tel.: +92-300-517-6845; Fax: +92-42-3656-0905.

Received: 31 October 2011 / Accepted: 8 November 2011 / Published: 8 December 2011

Abstract: Agriculture is the largest sector of Pakistan's economy, contributing almost 22% to the GDP and employing almost 45% of the total labor force. The two largest food crops, wheat and rice, contribute 3.1% and 1.4% to the GDP, respectively. The objective of this research was to calculate the energy return on investment (EROI) of these crops on a national scale from 1999 to 2009 to understand the size of various energy inputs and to discuss their contributions to the energy output. Energy inputs accounted for within the cropping systems included seed, fertilizer, pesticide, human labor, tractor diesel, irrigation pump electricity and diesel, the transport of fertilizer and pesticide, and the embodied energy of tractors and irrigation pumps. The largest per-hectare energy inputs to wheat were nitrogen fertilizer (52.6%), seed (17.9%), and tractor diesel (9.1%). For rice, the largest per-hectare energy inputs were nitrogen fertilizer (32%), tube well diesel (19.8%), and pesticide (17.6%). The EROI of wheat showed a gradual downward trend between 2000 and 2006 of 21.3%. The trend was erratic thereafter. Overall, it ranged from 2.7 to 3.4 with an average of 2.9 over the 11-year study period. The overall trend was fairly consistent compared to that of rice which ranged between 3.1 and 4.9, and averaged 3.9. Rice's EROI dipped sharply in 2002, was erratic, and remained below four until 2007. It rose sharply after that. As energy inputs increased, wheat outputs increased, but rice outputs decreased slightly. Rice responded to inputs with greater output and an increase in

EROI. The same was not true for wheat, which showed little change in EROI in the face of increasing inputs. This suggests that additional investments of energy in rice production are not improving yields but for wheat, these investments are still generating benefits. The analysis shows quantitatively how fossil energy is a key driver of the Pakistani agricultural system as it traces direct and indirect energy inputs to two major food crops.

Keywords: energy return on investment; per-hectare energy usage; wheat/rice output energy; wheat/rice input energy

List of Acronyms and Abbreviations

EROI	Energy return on investment
FAO	Food and Agriculture Organization (United Nations)
FY	Fiscal year (Pakistani fiscal year is July 1–June 30)
GAO	Government Accountability Office (USA)
GDP	Gross domestic product
GoP	Government of Pakistan
HDIP	Hydrocarbon Development Institute of Pakistan
HYV	High-yielding variety
IFA	International Fertilizer Industry Association (France)
IRRI	International Rice Research Institute
K	Potassium (fertilizer input)
N	Nitrogen (fertilizer input)
NEA	Net energy analysis
NFDC	National Fertilizer Development Centre (Pakistan)
P	Phosphorus (fertilizer input)
USD	United States dollars
USDA	United States Department of Agriculture (USA)

List of Units of Measurement

GJ	Gigajoule
GWh	Gigawatt-hour
ha	Hectare
HP	Horsepower
J	Joule
kg	Kilogram
kW	Kilowatt
MAF	Million acre-feet
MJ	Megajoule

m ²	Square meter
Mt	Megatonne (million tonnes)
t	Tonne/metric ton
toe	Tonnes of oil equivalent
PJ	Petajoule
PTO HP	Power take-off horsepower

1. Introduction

Traditional economic analyses make use of commodity market prices, buyer preferences, and energy prices (which themselves are influenced by multiple factors). “Energy” is a significant driver of economic growth and therefore key to understanding how agricultural systems function. This analysis aims to trace direct and indirect energy inputs into two major food crops in Pakistan. It also shows the energy return on investment (EROI) over time to explain the relationship between energy inputs and final output. It is different from conventional economic analysis because it utilizes real energy units rather than manmade prices. It accounts for human labor energy inputs and recognizes the energy input behind fertilizer and pesticide inputs. It incorporates the unique “embodied energy” concept where the energy used to manufacture inputs is accounted for. Furthermore, it accounts for the inefficiencies in the production of electricity. These are all elements that conventional economic analyses are unable to incorporate.

Pakistan is located in South Asia and borders the Arabian Sea to the south, India to the east, Iran and Afghanistan to the west, and China to the northeast. The total land area is 79.6 million hectares (ha), slightly less than twice the size of the state of California in the US. The country’s climate is mostly hot in the flat Indus plains, temperate in the northwest, and “arctic” in the north [1]. Mineral resources include iron ore, copper, salt, gold, limestone, poor quality coal, extensive natural gas reserves and limited amounts of petroleum [1].

With a population of approximately 166 million [2], Pakistan’s per-capita gross domestic product (GDP) in 2009 was USD 2,500 [1]. Its Gini index ranking in 2008 stood at 109 (Sweden’s topped the list at 30.6) [3].

Pakistan’s important export partners are the US, the UAE, Afghanistan, the UK, and China. Exports totaled approximately USD 14.4 billion in 2009 and included items such as “textiles (garments, bed linen, cotton cloth, yarn), rice, leather goods, sports goods, chemicals, manufactures, carpets and rugs” [1]. Major import partners are China, Saudi Arabia, the UAE, the US, Kuwait, Malaysia, and India. Import items totaled approximately USD 28.5 billion in 2009 and included “petroleum, petroleum products, machinery, plastics, transportation equipment, edible oils, paper and paperboard, iron and steel, tea.” [1].

Agriculture has always been the largest sector of Pakistan’s economy, contributing approximately 22% to the GDP and employing almost 45% of the total labor force ([4] p. 13). However, growth in the sector has been falling for the last 30 years; investments in important agricultural technologies such as water infrastructure and seed are low ([4] p. 13).

Value-added growth (post-harvest processing to add value) in the sector is erratic, due mainly to “major crops” such as wheat and rice (Table 1). Agricultural growth figures are often “rescued” by the relative successes of livestock, fisheries, and higher-value minor crops. The fluctuation in these figures is not necessarily a good indicator of crop performance because of the multiple forces that influence prices and markets of commodities. Utilizing EROI analysis helps provide insights that conventional economic analyses do not.

Table 1. Percentage change in value-added growth in the agricultural sector in Pakistan, 2001 to 2010.

Year	Agricultural growth (%)	Major crops (%) *	Minor crops (%) **
2001	-2.2	-9.9	-3.2
2002	-0.1	-2.5	-3.7
2003	4.1	6.8	1.9
2004	2.4	1.7	3.9
2005	6.5	17.1	1.5
2006	6.3	-3.9	0.4
2007	4.1	7.7	-1.0
2008	1.0	-6.4	10.9
2009	4.0	7.3	-1.7
2010 (provisional)	2.0	-0.2	-1.2

* Cotton, sugarcane, rice, wheat, pearl millet, rapeseed, mustard, maize, barley, gram; ** Oilseeds, pulses, potato, onion, chilies; Source: [4], p. 14; [5], p. 17; [6], p. 15.

Wheat and rice enjoy an important status among food crops in Pakistan. Wheat is the staple food crop of the country, while Pakistani *basmati* rice is known for its long-grained appearance and distinguished by its aroma [7]. Pakistan ranked sixth in the world in wheat production in 2009 [8]. However, the country still requires wheat imports to fulfill demand most years; Pakistan imported wheat seven times between 1999 and 2009 ([9], p. 205). Domestic wheat production has risen over time, but per capita availability has fluctuated considerably. Wheat and rice contribute 3.1% and 1.4% to the GDP, respectively ([4], p. 19). Pakistan’s total cultivated area was 23.8 million ha in 2009, of which wheat and rice occupied approximately 38.0% and 12.5% respectively (calculated from [9], pp. 3, 13, 108–110).

Wheat (*Triticum aestivum* L.) yields averaged 2.4 tonnes per hectare ($t\ ha^{-1}$) between 1999 and 2009 (calculated from [9], pp. 3–4). Wheat is a *rabi* or winter crop, *i.e.*, it is sown between October and December, and harvested between April and May ([4], p. 15), and often grows in rotation with rice, cotton, maize, sugarcane, pulses, and fallow land [10]. Like most agriculture in Pakistan, wheat production is highly dependent on irrigation ([4], p. 14). On average, *barani* or rain-fed wheat accounts for only 6.5% of total wheat production (calculated from [9], p. 10–11).

Domestic rice (*Oryza sativa* L.) yields averaged 2.1 $t\ ha^{-1}$ between 1999 and 2009 (calculated from [9], p. 14). It is a major cash crop and both consumed locally and exported. Rice is a *kharif* or summer crop sown between April and June, and harvested between October and December ([4], p. 15). Like wheat, rice in Pakistan is heavily dependent on irrigation. The entire crop (with the exception of a very small area in the mountainous region) is usually grown in irrigated or partially irrigated systems [11].

Rainfall patterns are erratic, so the country's agriculture depends heavily on irrigation water. The monsoon rains of July–September are essential for recharging reservoirs and lakes that feed into rivers, and subsequently the canal irrigation system. Global El Niño weather systems generally weaken the monsoon rains in South Asia [12] and can adversely influence agriculture. For example, in 1997 during an El Niño event, there was insufficient moisture until August (rice is sown between April and June), followed by severe floods and landslides [13].

1.1. Agricultural Inputs in Pakistan

Fertilizer is used extensively in Pakistan, and the amount used has risen from 2.6 million nutrient tonnes in 1999 to 3.7 million nutrient tonnes in 2009. The ratio between nitrogen, phosphorus, and potassium-based fertilizers (N:P:K ratio) averaged 1:0.28:0.01 from 1998 to 2007 (calculated from [14], p. 61). This is also supported by the Food and Agriculture Organization (FAO) [15]. Potash application has been low historically, and only two percent of farmers countrywide actually apply it [15]. This is further supported by scattered wheat and rice-specific figures supplied by FAO and International Fertilizer Industry Association (IFA) sources that show exceptionally low figures ranging from 0.7–3.5 kg ha⁻¹ on wheat and 0.2–1.0 kg ha⁻¹ on rice in various years since 1989 (with the exception of 1992–1993 where potash application was high at 11.3 kg ha⁻¹) [16–20].

Pesticide application on crops in Pakistan began to expand in the early 1980s, increasing from 3,500 tonnes in 1981 [21] and growing by a factor of 27 to 94,265 tonnes in 2007 ([9], p. 150). Much of Pakistan's pesticide was imported until the late 1990s, but now domestic production exceeds 60% of the amount used annually [21]. In Pakistan, most "pesticide" is insecticide applied largely to cotton and rice [22]. Wheat is the largest user of herbicide against grasses such as little seed canary grass (*Phalaris minor*) which, in Pakistan, is said to reduce wheat yields by 15–20% in the absence of herbicides [22]. Forty-eight percent of farmers believe that pesticide is a necessary input to increase crop yield [22]. However, the same survey shows that 97% of farmers believe pesticides are adulterated [22].

Tractors have become the dominant mode of traction power in agriculture and bullock-operated farms are on the decline [23]. The number of tractors being used in Pakistan increased by a factor of 85 between 1961 and 2007 [24]. Most of the country's wheat crop is threshed with machines and mechanical rice husking is also on the rise [23]. Farmers who do not either own or rent tractors are few and far between [25]. In addition, recent data shows that 90% of farms use tractors in contrast to only 17% in 1972 [21]. This figure climbs to 96% in The Punjab and Sindh regions of Pakistan [21].

Given Pakistan's dry climate and low average rainfall, irrigation has been a major part of agriculture in the region since 3,000 BC. Canal irrigation sources include glaciers in the north, snowmelt, and rainfall outside the Indus Plains [21]. Groundwater is an integral part of irrigation; the canal system is becoming more of a groundwater recharge mechanism than a water delivery system [21]. This is especially true of The Punjab province where recharge from canals is responsible for 80% of pumped groundwater [26]. On average, groundwater accounted for 36.7% of available irrigation water between 1999 and 2010 (calculated from [9], p. 138–139).

1.2. Study Background and Basis

Energy analysis is not new to agriculture. The literature shows a vast quantity of research on the issue, especially for energy crops (ethanol) such as sugarcane and corn. Various writers including Shapouri and Salassi (2006) have performed energy analyses on agricultural systems [27]. The basic methodology is the same in most cases. What differs is the definition of “appropriate” input to the systems. Studies show EROI ratios for US corn-based ethanol both above and below one [28]. The reasons for these differences include the accounting of co-products, the exclusion of the embodied energy of equipment, and the use of internally-derived energy sources [28]. Defining study boundaries clearly is important and we define them for this study in Section 2.1.

Pakistan’s agricultural sector shows an increasing dependence on fossil fuel inputs in the form of fertilizer, pesticide, and mechanization, a common trend worldwide. The 1960s and 1970s were characterized by massive yield increases [29] due to improved varieties, petroleum-based fertilizers and pesticides, irrigation, and diesel-driven tractors [30-32]. For example, nitrogen (N) fertilizer usage in Pakistan increased from an average of 36,000 tonnes in 1960–1963 to 326,000 tonnes in 1970–1973, to 876,000 tonnes in 1980–1983 [21]. The new crop varieties that were developed relied upon increasing amounts of fossil fuel inputs. Crosson and Brubaker (1982) stated with reference to new agricultural technologies that “Not only is the technology itself keyed to energy from fossil fuels, but the research establishment that developed the technology also is oriented to exploitation of this resource” [33]. The direct link between increased energy usage and increased agricultural output has been researched widely [34-37]. This notion has sparked debate on long-term yield viability and environmental degradation [38-40].

The relatively few studies on energy use in agriculture in Pakistan cover small districts using site-specific data. However, Jameel’s (1982) study provides a detailed analysis of energy use in Pakistani agriculture. He found that fertilizer production accounted for 45% of all commercial energy supplied to the agricultural sector. Another 40% was used for irrigation and drainage [41].

A more recent Pakistani study examined energy use on sugar cane crops in Dera Ismail Khan District. It compared energy inputs to sugarcane yields and discovered that fertilizer and irrigation were the largest energy inputs. The results showed that energy consumption was higher on tractor-operated farms than bullock-operated farms by a factor of 1.2. The energy output-input ratios were marginally higher for bullock-operated farms [42]. Similarly, Khan and Singh (1996 and 1997) studied energy use on sugar cane and wheat in the same district [43,44]. However, all three analyses restricted the usage of “energy analysis” to direct use: human labor, animal power, diesel and electrical irrigation motors, and tractors. Furthermore, the premise of such studies was to compare energy usage and energy outputs between different categories of farms such as tractor-operated farms and bullock-operated farms. They found that per-hectare energy usage was the highest on farms using electrical or diesel-powered pumps for groundwater pumping. The output-input analysis showed that while crop yields were higher on irrigated farms, yield increases were *not* proportional to increases in energy input. This implies that farmers were investing large quantities of energy, but not harvesting proportional crop output. The reasons ranged from overwatering to excessive energy inputs to the point where they do not contribute positively to output. This is addressed in greater detail in section 4. Other studies in neighboring countries such as India [45-47] also quantified inputs (seed, fertilizer,

pesticide) in energy terms. The purpose of such studies were generally the same, citing, for example, the need for an understanding of the fact that fertilizer and chemical pesticides are produced through fossil energy-intensive processes, and that perhaps yields could be increased or at least maintained through the judicious use of such inputs and the supplementation of inputs with farmyard manure [45].

To our knowledge, an energy analysis of the entire crop production system for the main crops grown in Pakistan has not been completed to date. The objective of this study therefore, is to perform an EROI analysis of the country's entire wheat and rice crops from 1999 to 2009 using extant secondary data, and to examine the size of the contribution of different inputs in relation to the output in total, and on a per-hectare basis. The purpose of this is to provide some insight on the trends in energy use and identify the main energy inputs. In addition, labor is represented unevenly in economic analyses because it is comparatively cheap in Asia and Pakistan. Considering it from an energy point of view removes this discrepancy. Furthermore, this analysis draws attention to the fact that fertilizer and pesticide are produced using highly energy intensive industrial processes. Price may not always reflect this adequately. This data can then be used to guide decisions about investments in the management of these cropping systems in a possibly energy-constrained future.

1.3. Energy Return on Investment Review

The concept of quantifying energy inputs and comparing them to energy outputs is rooted in an energy accounting method called "net energy analysis" (NEA). The central idea of NEA is that net energy is the gross energy output resulting from a given process minus the energy required to obtain it [the gross energy] [48]. The output must be greater than the input (sometimes termed "feedback") in order to be energetically feasible. Energy return on investment, on the other hand, studies the energy output and inputs by means of a ratio. It is generally applied to the mine-mouth, wellhead, or farm-gate [49]. Thus, an EROI ratio of 100:1 means that 100 units of energy are produced for every one unit of energy invested to locate, extract, produce, and upgrade the energy source or product being studied. By the strict logic of a 1:1 EROI, foods such as beef, chicken, eggs, cauliflower, winter tomatoes, lettuce, and various seafoods could be considered unfeasible as they commonly require more energy to grow, harvest, or catch, and deliver to consumers than their own energy content [38]. Thus, it should be understood that everything cannot be evaluated simply in reference to a greater-than-one EROI without considering the importance of the quality of the output. Human beings make specific choices where affluence often allows nutrition and palatability to overshadow simple energy return. Understanding and being aware of the implications of these choices in terms of energy is important in understanding how resources are allocated and used.

The NEA concept has existed in the US since the 1950s [50]. Conducting NEAs is required by the Federal Nonnuclear Energy Research and Development Act of 1977 and The Energy Security Act of 1980 [51,52]. Net energy analysis is commonly used to evaluate the feasibility of energy projects such as electricity generation plants and various renewable energy technologies. This method of energy analysis is well-defined, and NEA offers a basis for reducing and conserving input energies, guarantees the chance to evaluate net energy yields independent of economic risk questions, and allows comparisons between the net energy yields of specific industrial plants and processes [53].

The value of NEA as a tool for resource-use analysis is derived chiefly from the fact that it assesses *physical* resources and is therefore resistant to market imperfections that may distort monetary data [54]. However, historical energy data is not always available, and in some situations, monetary data must be used to infer energy values. It is believed that NEAs reflect real value more accurately than monetary metrics because they use specific energy units rather than dollars which are affected by such variables as time, markets, changing tastes, living standards, and public policies [52]. The US Comptroller General acknowledged that economic analyses were required to evaluate energy projects, but that “Dollar measurements do not substitute for NEA because they are not based on explicit physical energy requirements and because of imperfections in the energy marketplace” [53]. In addition, NEAs can often be used to point out where improvements can be made in system operations [52].

Many neoclassical economists dispute the value of NEA, arguing that they do not contribute much more additional useful information than does a thorough economic analysis [54]. Most analyses of agricultural output are indeed done in monetary terms. The question then is, why use energy terms instead, when a wealth of economic tools already exist for studying the feasibility and profitability of an economic activity?

Our justification for performing an EROI analysis is two-fold. First, as Hall *et al.* (1986) point out, “energy is the ultimate limiting resource” [38]. While it is incorrect to say that everything can be reduced to energy, it is important to understand that all material and most nonmaterial resources have an associated energy cost. Second, energy flows are governed by the irrefutable laws of thermodynamics formulated by Joule, Clausius, and Thomson. This implies that the flows of energy through an agricultural system are subject to energy “losses” which must be accounted for. Monetary measures are not subject to these natural laws, and money, unlike energy, can be generated indefinitely. As mentioned earlier, they are influenced by social forces related to the economy such as inflation, public policy, and markets [52].

2. Methodology

2.1. System Boundaries

Conducting an EROI analysis requires a clear definition of the system being studied, in this case the agricultural systems of wheat and rice in Pakistan, and the energy flows that are being measured. The energy inputs considered are the fossil fuel inputs needed to produce wheat and rice and the output is the energy stored in the harvested crops at the farm-gate. Crop residues have varied uses as well—such as fodder and fuel—and it is possible that accounting for them would increase EROI figures. However, this analysis is concerned only with the edible (human) energy produced in these systems. It is noteworthy that crop residues such as wheat straw, cotton stems, sugar cane trash/tops and rice husks are *not* recycled in the soil in Pakistan where they could add to soil fertility [15]. However, we have not accounted for this as relevant secondary data is not available. The energy inputs quantified in this system are seed, fertilizer, pesticide, the energy to operate tractors and tube wells and their embodied energy, the energy used to transport fertilizer and pesticide locally, and energy invested in the form of human labor (Figure 1).

Figure 1. System boundaries for an EROI analysis of wheat and rice production in Pakistan.

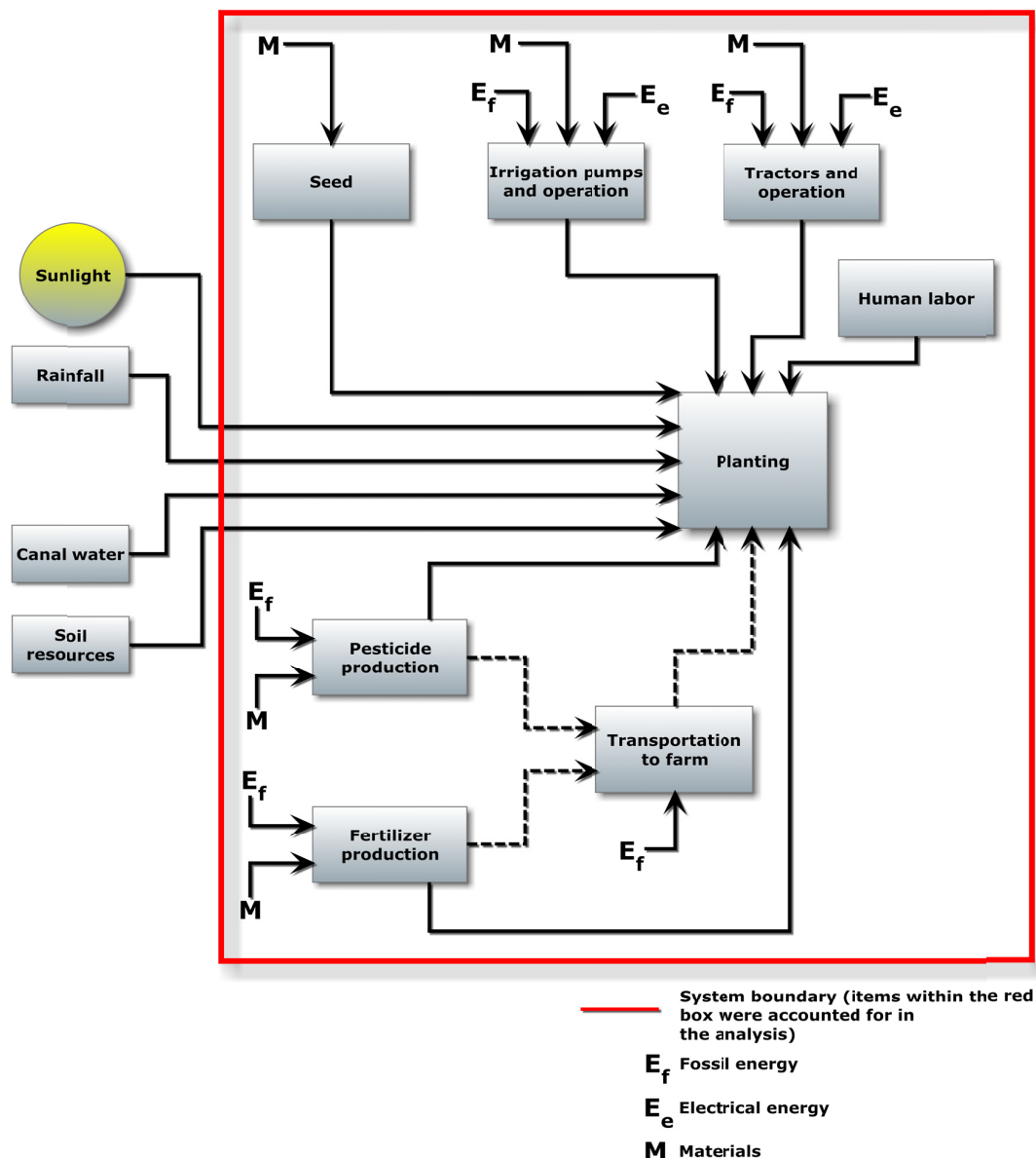

Inputs such as sunlight and rainfall are considered as natural inputs with no energy investment required by humans. Furthermore, as this is an energy analysis, there is the concern of resource depletion. The sun is considered an unlimited stock of energy whereas fossil fuels on earth are non-renewable, and therefore limited [55,56]. We excluded the sun for this reason. The output from the system is at the farm-gate, so post-harvest energy costs such as crop transport, storage, and processing were not included in this analysis [49]. Finally, environmental energy costs such as lost environmental services due to ecosystem degradation are beyond the ambit of this study, and while they are important for the long-term sustainability of these production systems, they were not included in this analysis.

2.2. Determining Energy Values

Data on the energy inputs into the system are all expressed in terms of energy in joules (J). However, since input data for agriculture is seldom collected in terms of energy, we converted available data to energy units using established conversion factors, which are outlined below.

2.2.1. Seed Input

We used an energy content of 14.2 MJ kg^{-1} for wheat seed [57]. Wheat seeding rates vary across the country depending on farmer awareness and access to technology—such as seed drills—and there is a lack of information on the extent of the different rates. We used a seeding rate of 150 kg ha^{-1} that is cited as being widely used [58].

Categories of rice varieties in Pakistan are shown in available statistics as “*basmati*”, “Irri”, and “other” [9]. Again, as further information is not available, we selected an energy value of 14.2 MJ kg^{-1} for *basmati* which is a mean value of the energy content of several popular brands of *basmati* rice available in Pakistan including “Aziz rice”, and two different packages each of “Guard rice” and “Reem rice” (energy values on branded rice packaging 2010). The Irri variety refers to various coarse-grained rice varieties which generally have slightly higher energy contents than *basmati* rice. We used a value of 15.3 MJ kg^{-1} for coarse varieties [57]. The category “other” is planted in only 9.3% of total rice cropped area between 1999 and 2009 (calculated from [9], pp. 16-17). The fact that it occupies such a small percentage of the total cropped area, while *basmati* occupied almost 60% in most years, could mean that it refers to higher-energy rice varieties. *Basmati*'s energy value is lower, but it is considered a cash crop and is exported worldwide for its palatability. The “other” category was therefore assigned the same energy value assigned to Irri varieties. The recommended seeding rates of 13.8 kg ha^{-1} for *basmati* varieties and 22.2 kg ha^{-1} for coarse varieties were used [59]. As there is no such information on “other”, we applied the higher seeding. We used static seeding rates across the country, therefore the amount of seed (and thus “seed energy”) varies annually depending on the amount of land cultivated for each crop or variety (Table 2). The calculation involved was “*seeding rate (kg ha⁻¹) × land area (ha) × energy content of seed (MJ kg⁻¹).*”

Table 2. Cultivated area of wheat and rice varieties in Pakistan (million ha) from 1999–2009.

FY *	Wheat area (million ha)			Rice area (million ha)			
	HYV	Others	Total	Basmati	Irri	Others	Total
1999	7.7	0.5	8.2	1.2	1.0	0.2	2.4
2000	8.1	0.3	8.5	1.3	1.0	0.2	2.5
2001	7.9	0.3	8.2	1.2	0.9	0.3	2.4
2002	7.8	0.3	8.1	1.3	0.7	0.1	2.1
2003	7.8	0.2	8.0	1.4	0.7	0.1	2.2
2004	8.0	0.2	8.2	1.5	0.7	0.2	2.5
2005	8.2	0.2	8.4	1.6	0.7	0.3	2.5
2006	8.2	0.2	8.4	1.7	0.8	0.2	2.6
2007	8.3	0.3	8.6	1.6	0.8	0.2	2.6
2008	8.3	0.3	8.5	1.5	0.7	0.3	2.5
2009	8.8	0.3	9.0	1.7	0.9	0.4	3.0

* FY = fiscal year; HYV = high yielding variety; Source: [9], pp. 6-7, 16-17.

2.2.2. Fertilizer Input

The fertilizer usage rates used in this study are taken from government estimates, *i.e.*, wheat used 45.4%, and rice used 5.4% of all fertilizer applied in the country from 1997 to 2004. The government raised these estimates for subsequent years until 2008 to 50% for wheat and six percent for rice ([60], p. 62). We assumed that the same set of percentages that were applied from 2005 to 2008, apply to 2009 as well. Furthermore, government data assumes that these percentages for the amounts of total fertilizer extend to the amounts of nitrogen (N), phosphorus (P), and potassium (K) (cross-referenced between [9], p. 127 and [60], p. 62). We used these percentages to calculate crop-specific N, P, and K usage figures ([14], p. 62).

The embodied energy of fertilizer reported in different studies varies depending on the manufacturing process and type of fertilizer [61-63]. We erred on the side of caution by using Shapouri *et al.*'s (2002) figures as they are closest to other published figures without being excessively high [61,64]. These values are 43.0 GJ t⁻¹ for N fertilizer, 4.8 GJ t⁻¹ for P fertilizer, and 8.7 GJ t⁻¹ for K fertilizer [61,64]. The calculation of this energy input is "*fertilizer applied (t) × embodied energy of fertilizer (GJ t⁻¹).*"

2.2.3. Pesticide Input

Crop-specific pesticide usage is not available. We therefore used a 2002 government calculation that was based on extensive field surveys in all four provinces, for the entire period under investigation. Results from this survey indicate that approximately nine percent of all pesticide in Pakistan is applied to wheat and 23% to rice. The remaining pesticides are used on cotton (54%), fruits and vegetables (8%), sugarcane (5%), and maize (1%; [22], p. 13). From this survey, it was possible to estimate percentages of the amount of herbicide, pesticide, and fungicide used on each crop ([22], pp. 13 and 15). For wheat, 80.6% of the pesticide used is herbicide, 19.2% is insecticide, and 0.2% is fungicide. For rice, 1.3% is herbicide, 98.7% is insecticide, and under 0.1% is fungicide (calculated from [22], pp. 13 and 15). Since data is not available on which specific herbicides were used on the crops, we used an average embodied energy value of 264 MJ kg⁻¹ for 24 different herbicides that might be used ([65] based on [66]). The corresponding conversion factors for insecticide (a mean value for 11 different insecticides) and fungicide (a mean value for four different fungicides) were 214 MJ kg⁻¹ and 168 MJ kg⁻¹, respectively [65,66]. The calculation involved is simply "*herbicide or insecticide or fungicide used (tonnes) × pesticide embodied energy (MJ t⁻¹).*"

2.2.4. Labor Input

Human labor input was calculated as energy expended by farmhands per hour per hectare per year. The number of person-days of labor expended on Pakistan's wheat crop was assumed to be 10.8 days ha⁻¹ year⁻¹ and 22.7 days ha⁻¹ year⁻¹ for rice from Ahmad and Martini's (2000) field estimates in The Punjab [67]. Assuming that the average farmhand workday is ten hours [68], then 108.2 person-hours ha⁻¹ year⁻¹ are required for wheat, and 227.1 person-hours ha⁻¹ year⁻¹ for rice. The

formula to calculate the amount of energy expended is “*person-hours (hours ha⁻¹) × cropped area (ha) × 60 (minutes) × 60 (seconds) × 671.1 (J second⁻¹).*” The figure 671.1 J second⁻¹ is the assumed power rating of human beings (0.7 kW) [69].

2.2.5. Tractor Diesel Input

The energy required to operate tractors was calculated using the formula “*rated power (kW) × time consumed (hrs ha⁻¹ × cropped area [ha]) × load factor.*” The rated power used was 46 horsepower (HP), which was the median value for the range of tractor engine sizes being used [70, Table 32] since hours of operation figures are not available for specific categories of engine size. Khan and Singh (1996) used a mean value of 50 HP in their smaller-area analysis [43]. Tractor operation time was 17.5 hours ha⁻¹ for wheat and 4.2 hours ha⁻¹ for rice from Ahmad and Martini’s (2002) field estimates from The Punjab [67]. The load factor (a dimensionless ratio), which is calculated as actual diesel consumed divided by diesel consumed at rated power, was taken as 0.5 for tractor engines [44].

2.2.6. Tractors Embodied Energy Input

The embodied energy in megajoules of *one* tractor for *one* year was calculated as “*(46 HP/1.2) × (31.9 kg (PTO HP)⁻¹) × (143.2 MJ kg⁻¹)/(18.8 years) = 9,309.4 MJ year⁻¹.*”

The median tractor engine size of 46 HP was used. Dividing by 1.2 converts HP to power take-off (PTO) HP [71]. The tractor-to-power ratio is 31.9 kg PTO HP⁻¹ [72], the energy-equivalent-of-machinery-weight is 143.2 MJ kg⁻¹ [73], and the lifespan of an average Pakistani tractor is 18.8 years, which was calculated assuming that the average tractor in Pakistan runs for 973.1 hours a year (calculated from [70, Table 32]). It was assumed that tractors should be replaced after 18,316 hours, assuming nominal maintenance over time [74]. This is consistent with Smil’s (1991) suggestion of prorating tractor life over 10–20 years [75].

The “tractor-hours per hectare” figures of 17.5 hours ha⁻¹ for wheat and 4.2 hours ha⁻¹ for rice were used to apportion the embodied energy between the two crops. If 17.5 tractor-hours are required for one hectare of wheat per year, then 973.1 tractor-hours are required for 55.6 ha of wheat per year. The same calculation for rice is 321.7 ha year⁻¹. Finally, 9,309.4 MJ year⁻¹ divided by 55.6 ha year⁻¹ = 167.4 MJ ha⁻¹ of wheat per year, and 40.2 MJ ha⁻¹ of rice per year. Multiplying 167.4 MJ year⁻¹ and 40.2 MJ year⁻¹ by the number of hectares of wheat and rice fields respectively, yields crop-specific tractor embodied energy figures.

2.2.7. Tube Well Diesel and Electricity Input

We calculated the amount of groundwater pumped per motor (Table 3, Column 6), knowing the number of diesel and electric pumps (Table 3, columns 2–4; [9], pp. 171 and 172) in the country and the amount of groundwater available in the *rabi* season (Table 3, column 5; [9], pp. 138–139). We then calculated wheat’s total water requirement using the formula “*water requirement (meters) × irrigated wheat area (m²),*” where the water requirement is 0.4 m per cropping season [76] and the irrigated wheat area ranges 69.0–78.2 billion m² (Table 3, Column 7; [9], pp. 8–9). Since groundwater accounts for 43.0–46.2% of available irrigation water in the *rabi* season (calculated from [9], p. 138–139), we

assumed that all *rabi* crops receive the same proportion of groundwater (Table 5). We calculated the amount of wheat's total water requirement that comes from groundwater resources (Table 3, Columns 8–9) and the number of motors that would be needed to pump this amount of water (Table 3, Column 10). These motors were apportioned into diesel and electric pumps based on the percentage (Table 6, calculated from [9], pp. 171–172) of each type in the country (Table 3, Columns 11–12). The same calculations were performed for rice (Table 4).

Knowing the number of motors of each type required to pump wheat's required groundwater, we calculated the energy they would use with the formula "*rated power (kW) × time consumed (days year⁻¹ × hours day⁻¹ × number of motors) × load factor*" [44]. Rated power refers to a mean power rating of 10.17 kW (13.5 HP). Mean operating times of 184 days year⁻¹ for six hours day⁻¹ for electric pumps, and 125 days year⁻¹ for five hours day⁻¹ for diesel pumps were assumed from 2004 agricultural census data ([9], p. 176). The load factor is actual diesel/electricity consumed divided by diesel/electricity consumed at rated power, taken as 1.0 for electric motors, and 0.6 for diesel-powered ones [44]. Table 7 is a calculation example for both diesel and electrical motors pumping water for wheat.

To account for the primary energy used to produce the electricity that runs irrigation pumps in Pakistan, we assumed a general conversion of 1,000 tonnes of oil equivalent (toe) to 11.63 GWh, and calculated efficiency figures for coal, oil, and natural gas using figures for amounts of fossil fuel used and the resultant electrical energy produced ([77], pp. 67, 70, 79, 89; [78], p. 67; [79], p. 70; [80], p. 73; [81] p. 81). Hydropower efficiency can be anywhere between 80% and 95% [82]. Nuclear power efficiency ranges between 33% and 37% [83]. We selected the more conservative 80% and 33%, respectively. Knowing what percentage of total electricity generation each technology is responsible for (calculated from [77], p. 89; [79], p. 70; [80], p. 73; [81], p. 81), we used weighted averages to calculate a "loss factor." The input electrical power to the irrigation pumps was divided by this factor (which averaged 0.5 over the study period) to account for the primary energy used to generate that electricity.

The final diesel and adjusted electricity figures are shown in Table 10. These calculations assumed that government-owned tube wells operate roughly the same number of hours as privately-owned tube wells, as operating time data was available only for privately-owned tube wells.

Table 3. Number of diesel and electric motors required to pump groundwater for wheat grown in Pakistan.

1	2	3	4	5	6	7	8	9	10	11	12
FY	Electric pumps (000)	Diesel pumps (000)	Total pumps (000)	Total rabi GW (MAF)	GW per pump (MAF)	Wheat's total water req. (MAF)	% that is from GW sources	Wheat req. fulfilled from GW sources (MAF)	No. of pumps req. to pump this (C9) (000)	Electric pumps (000)	Diesel pumps (000)
1999	117.4	445.8	563.2	25.6	<0.1	22.4	45.3	10.1	222.6	46.4	176.2
2000	112.4	497.4	609.8	25.0	<0.1	23.4	44.3	10.4	252.8	46.6	206.2
2001	113.7	545.5	659.3	25.4	<0.1	22.8	44.6	10.2	263.7	45.5	218.2
2002	116.8	590.4	707.3	25.3	<0.1	22.8	44.4	10.1	282.7	46.7	236.0
2003	120.6	648.4	769.0	25.3	<0.1	22.7	44.3	10.1	306.1	48.0	258.1
2004	132.0	818.2	950.1	25.3	<0.1	23.1	44.2	10.2	384.3	53.4	330.9
2005	137.0	847.3	984.3	25.3	<0.1	23.4	43.9	10.3	400.9	55.8	345.1
2006	143.7	855.9	999.6	25.7	<0.1	23.8	43.0	10.2	398.2	57.2	341.0
2007	116.7	814.6	931.3	25.7	<0.1	23.8	46.2	11.0	398.8	50.0	348.9
2008	120.8	800.3	921.1	25.5	<0.1	23.9	44.8	10.7	387.2	50.8	336.4
2009	120.8	800.4	921.2	24.8	<0.1	25.4	45.9	11.6	432.7	56.7	375.9

"GW" = groundwater; "MAF" = million acre-feet; "C9" = figures in column nine.

Table 4. Number of diesel and electric motors required to pump groundwater for rice grown in Pakistan.

1	2	3	4	5	6	7	8	9	10	11	12
FY	Elect. pumps (000)	Diesel pumps (000)	Total pumps (000)	Total kharif GW (MAF)	GW per pump (MAF)	Rice's total water req. (MAF)	% that is from GW sources	Rice req. fulfilled from GW sources (MAF)	No. of pumps req. to pump this (C9) (000)	Electric. pumps (000)	Diesel pumps (000)
1999	117.4	445.8	563.2	25.5	< 0.1	18.9	33.0	6.2	137.6	28.7	108.9
2000	112.4	497.4	609.8	24.9	< 0.1	19.6	32.4	6.3	155.2	28.6	126.6
2001	113.7	545.5	659.3	25.1	< 0.1	18.5	32.3	6.0	157.0	27.1	129.9
2002	116.8	590.4	707.3	25.0	< 0.1	16.5	32.2	5.3	150.0	24.8	125.2
2003	120.6	648.4	769.0	24.8	< 0.1	17.3	32.0	5.5	171.9	27.0	145.0
2004	132.0	818.2	950.1	24.8	< 0.1	19.2	31.9	6.1	234.4	32.6	201.8
2005	137.0	847.3	984.3	24.8	< 0.1	19.6	31.7	6.2	246.9	34.4	212.5
2006	143.7	855.9	999.6	24.7	< 0.1	20.4	31.8	6.5	262.7	37.8	224.9
2007	116.7	814.6	931.3	24.7	< 0.1	20.1	30.0	6.0	227.4	28.5	198.9
2008	120.8	800.3	921.1	24.5	< 0.1	19.6	28.6	5.6	210.7	27.6	183.1
2009	120.8	800.4	921.2	23.9	< 0.1	23.1	26.9	6.2	239.0	31.3	207.7

"GW" = groundwater; "MAF" = million acre-feet; "C9" = figures in column nine.

Table 5. Seasonal groundwater expressed as a percentage of total available irrigation water in Pakistan.

FY	Kharif season			Rabi season		
	GW (MAF)	SW + GW (MAF)	GW % of (SW + GW) (MAF)	GW (MAF)	SW + GW (MAF)	GW % of (SW + GW) (MAF)
1999	25.5	77.2	33.0	25.6	56.6	45.3
2000	24.9	76.9	32.4	25.0	56.4	44.3
2001	25.1	77.7	32.3	25.4	57.1	44.6
2002	25.0	77.6	32.2	25.3	57.1	44.4
2003	24.8	77.5	32.0	25.3	57.0	44.3
2004	24.8	77.6	31.9	25.3	57.2	44.2
2005	24.8	78.2	31.7	25.3	57.5	43.9
2006	24.7	77.6	31.8	25.7	59.7	43.0
2007	24.7	82.3	30.0	25.7	55.5	46.2
2008	24.5	85.6	28.6	25.5	56.9	44.8
2009	23.9	88.9	26.9	24.8	54.0	45.9

“GW” = groundwater; “SW” = surface water.

Table 6. Electric and diesel pumps expressed as a percentage of total pumps.

FY	Total pumps	Electric pumps	Diesel pumps	Electric pumps % of total	Diesel pumps % of total
		(millions)			
1999	0.6	0.1	0.4	20.8	79.2
2000	0.6	0.1	0.5	18.4	81.6
2001	0.7	0.1	0.5	17.3	82.7
2002	0.7	0.1	0.6	16.5	83.5
2003	0.8	0.1	0.6	15.7	84.3
2004	1.0	0.1	0.8	13.9	86.1
2005	1.0	0.1	0.8	13.9	86.1
2006	1.0	0.1	0.9	14.4	85.6
2007	0.9	0.1	0.8	12.5	87.5
2008	0.9	0.1	0.8	13.1	86.9
2009	0.9	0.1	0.8	13.1	86.9

Table 7. Energy share of diesel and electric motors required to pump groundwater to wheat in Pakistan (calculation example).

FY	Pumps (millions)	Days per year	Hours per day	Total hours per pump	Total hours for all pumps (millions)	Diesel/electricity (unadjusted) on wheat (PJ)
2009 (diesel)	0.4	125	5	635	235.0	8.6
2009 (electric)	<0.1	184	6	1,104	62.6	2.3

Table 8. Embodied energy of diesel and electric pumps watering wheat in Pakistan (calculation example).

FY	No. of diesel/electric pumps watering wheat (000)	AFEC (MJ kg ⁻¹ -year)	Weight (kg; one pump)	Total embodied energy of one pump (MJ)	Total embodied energy of all pumps (PJ)
2009 (diesel)	375.9	4.5	275	1,237.5	0.5
2009 (electric)	56.7	6.8	275	1,870.0	0.1

Table 9. Imported fertilizer and pesticide percentages of totals used.

FY	Imported fertilizer (% of total used)	Imported pesticide (% of total used)
1999	34.2	59.6
2000	23.4	32.2
2001	19.6	43.4
2002	21.4	38.8
2003	25.4	30.8
2004	23.7	31.2
2005	21.2	27.0
2006	33.3	29.2
2007	21.7	19.0
2008	24.5	23.7
2009	15.3	23.7

Source: Calculated from [9], pp. 127, 133, 150.

Table 10. Total inputs to wheat from 1999 to 2009 (PJ).

FY	'99	'00	'01	'02	'03	'04	'05	'06	'07	'08	'09	Avg-input
Seed	17.5	18.0	17.4	17.1	17.1	17.5	17.8	18.0	18.2	18.2	19.2	17.8
N	40.9	43.2	44.2	44.6	45.8	49.3	60.1	62.9	57.0	62.9	65.3	52.4
Fertilizer												
P	1.0	1.3	1.5	1.3	1.4	1.5	2.1	2.0	2.3	1.5	1.5	1.6
K	0.1	0.1	0.1	0.1	0.1	0.1	0.1	0.1	0.2	0.1	0.1	0.1
Herbicide	0.9	1.2	0.9	1.3	1.5	2.5	2.0	0.8	1.8	0.8	0.8	1.3
Pesticide												
Insecticide	0.2	0.2	0.2	0.3	0.3	0.5	0.4	0.2	0.3	0.1	0.1	0.3
Fungicide	0.0	0.0	0.0	0.0	0.0	0.0	0.0	0.0	0.0	0.0	0.0	0.0
Labor	2.2	2.2	2.1	2.1	2.1	2.1	2.2	2.2	2.2	2.2	2.4	2.2
Tractor diesel	8.9	9.2	8.9	8.7	8.7	8.9	9.1	9.2	9.3	9.3	9.8	9.1
Tractor embodied energy	1.4	1.4	1.4	1.3	1.3	1.4	1.4	1.4	1.4	1.4	1.5	1.4
Tube well diesel	4.0	4.7	5.0	5.4	5.9	7.6	7.9	7.8	8.0	7.7	8.6	6.6
Tube well electricity (adjusted)	3.6	3.9	3.9	4.0	4.0	4.2	4.6	4.3	4.0	4.2	4.7	4.1
Diesel tube well embodied energy	0.2	0.3	0.3	0.3	0.3	0.4	0.4	0.4	0.4	0.4	0.5	0.4
Electric tube well embodied energy	0.1	0.1	0.1	0.1	0.1	0.1	0.1	0.1	0.1	0.1	0.1	0.1
Transportation of fertilizer and pesticide	1.8	1.8	1.9	1.9	2.0	2.1	2.6	2.8	2.6	2.6	2.6	2.2
Total	82.7	87.6	87.8	88.6	90.6	98.1	110.8	112.3	108.0	111.5	117.2	99.6

2.2.8. Tube Well Embodied Energy Input

The embodied energy of tube wells was calculated using the formula “*average tube well pump weight (kg) × annual fixed energy cost (AFEC) to manufacture one pump (MJ kg⁻¹ year⁻¹) × number of pumps in Pakistan.*” The AFEC accounts for raw material, recycled material, an expected product life of 12 years for both types of motors, and assumes three motor replacements over a 40-year system life [84]. Average pump weight was assumed as 275 kg [85], manufacturing energy cost of diesel pumps as 4.5 MJ kg⁻¹ year, and of electric pumps as 6.8 MJ kg⁻¹ year [84]. This resulted in the total annual embodied energy for such pumps in MJ year⁻¹. Table 8 is a calculation example of the embodied energy of diesel and electrical pumps watering wheat.

2.2.9. Transport

We accounted for the energy used in the domestic transportation of fertilizer and pesticide inputs by assuming that the average distance these (locally produced) materials were moved was 200 km (estimated from the distance between input production points and major cropped areas). For imported fertilizer and pesticide, we assumed the average transportation distance as 300 km (estimated from the distance between the country’s main seaport, Karachi, and major cropped areas). We did not account for international shipping as data on where various products are imported from is unavailable. We assumed that wheat and rice receive the same percentage of imported and domestically produced

fertilizer and pesticide as the percentages of total national imported and domestically produced fertilizer and pesticide (Table 9). Finally, we assumed the energy value of transporting one kilogram of material as 6.4 megajoules per tonne-kilometer (MJ t-km⁻¹) [49]. Combining this information with distance-travelled figures, the energy to transport one tonne of imported material is 1,920 MJ, and the energy to transport one tonne of domestically produced material is 1,280 MJ.

2.3. Consolidated Energy Inputs

Tables 10 and 11 show all inputs to wheat and rice quantified in energy terms.

Table 11. Total inputs to rice from 1999 to 2009 (PJ).

FY	'99	'00	'01	'02	'03	'04	'05	'06	'07	'08	'09	Average input
Seed	0.6	0.7	0.6	0.5	0.6	0.6	0.6	0.7	0.6	0.6	0.8	0.6
N	4.9	5.1	5.2	5.3	5.4	5.8	7.2	7.6	6.8	7.5	7.8	6.3
Fertilizer												
P	0.1	0.2	0.2	0.2	0.2	0.2	0.2	0.2	0.3	0.2	0.2	0.2
K	0.0	0.0	0.0	0.0	0.0	0.0	0.0	0.0	0.0	0.0	0.0	0.0
Herbicide	0.0	0.0	0.0	0.1	0.1	0.1	0.1	0.0	0.1	0.0	0.0	0.1
Pesticide												
Insecticide	2.2	3.0	2.3	3.4	3.8	6.3	5.1	2.1	4.6	1.9	1.9	3.3
Fungicide	0.0	0.0	0.0	0.0	0.0	0.0	0.0	0.0	0.0	0.0	0.0	0.0
Labor	1.3	1.4	1.3	1.2	1.2	1.4	1.4	1.4	1.4	1.4	1.6	1.4
Tractor diesel	0.6	0.7	0.6	0.5	0.6	0.6	0.7	0.7	0.7	0.7	0.8	0.6
Tractor embodied energy	0.1	0.1	0.1	0.1	0.1	0.1	0.1	0.1	0.1	0.1	0.1	0.1
Tube well diesel	2.5	2.9	3.0	2.9	3.3	4.6	4.9	5.1	4.6	4.2	4.8	3.9
Tube well electricity (adjusted)	2.2	2.4	2.3	2.1	2.2	2.6	2.8	2.9	2.3	2.3	2.6	2.4
Diesel tube well embodied energy	0.1	0.2	0.2	0.2	0.2	0.2	0.3	0.3	0.2	0.2	0.3	0.2
Electric tube well embodied energy	0.1	0.1	0.1	0.0	0.1	0.1	0.1	0.1	0.1	0.1	0.1	0.1
Transportation of fertilizer and pesticide	0.2	0.2	0.2	0.2	0.3	0.3	0.3	0.4	0.3	0.3	0.3	0.3
Total	15.1	16.8	16.2	16.7	18.0	22.9	23.8	21.6	22.1	19.5	21.2	19.4

2.4. Quantifying the Energy Output (Crop Production)

The energy content of seed for planting and as the product of the cropping system were taken to be the same, and used official production figures from [9] (pp. 6–7, pp. 16–17) to calculate the energy output of the crops.

2.5. Energy Return on Investment Calculations

All of the energy inputs were added up and compared against crop production or energy output to calculate the EROI using the formula “ $EROI = \text{energy output} / \text{energy inputs}$.” [49].

2.6. Regression Analysis

Linear, quadratic, cubic, and quartic regressions were conducted for wheat and rice EROI over time ($x = \text{fiscal year}$, $y = \text{EROI}$) and for wheat and rice inputs per hectare against wheat and rice energy output per hectare ($x = \text{energy inputs per ha}$, $y = \text{energy output per hectare}$) using Analyze-it® version 2.22 for Microsoft Excel® [86].

The size of the energy input contribution of fertilizer and pesticide to both crops is noteworthy.

3. Results

3.1. Energy Return on Investment

The EROI of wheat shows a gradual downward trend from 2000 to 2006. There was an overall decrease of 21.3% during that time period. After that, the trend is erratic registering alternative increases and decreases. The EROI of rice shows a decreasing trend until 2005 (with variability within that trend). Thereafter, it rises fairly rapidly, an increase of 56.2% between 2005 and 2009. Rice’s EROI was consistently higher than wheat’s in the same year. Wheat’s EROI trend is fairly constant in that it hovers above or below the 3.0 mark throughout. Rice’s performance is variable, but the general trend appears to be a decrease that lasts halfway through the study period, followed by a steady increase (Figure 2).

The linear and quadratic regressions for wheat EROI were significant. Cubic and quartic regressions were not (Table 12). For rice EROI, the quadratic, cubic, and quartic regressions were significant (Table 13). However, the residual sum of squares values indicates that the quartic regression equation is the best fit for both wheat and rice EROI.

Figure 2. Energy return on investment of wheat and rice produced in Pakistan and the percentage change in the EROI from the previous year (1999–2009). Percentage change figures at the top of the figure are for rice and in the middle of the figure for wheat.

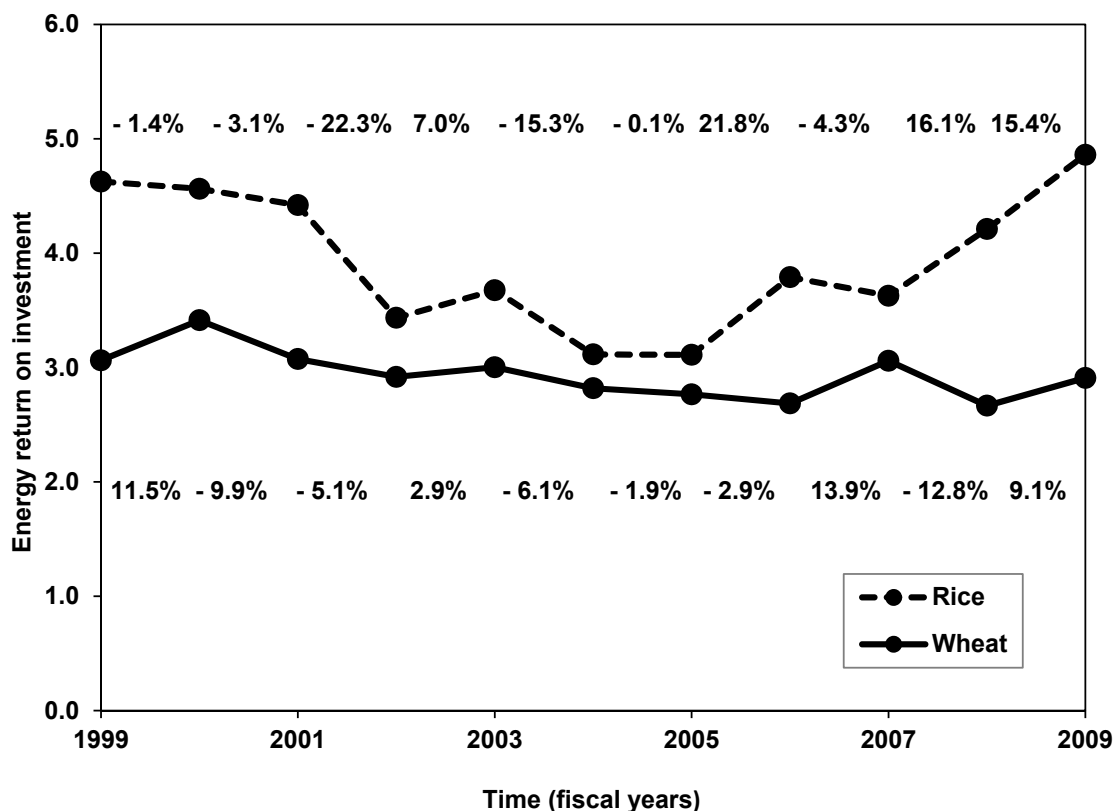

Table 12. Regressions-fiscal year vs. wheat EROI.

Regression	r^2 value	Adjusted r^2 value	p-value	Residual sum of squares	Equation
Linear	0.40	0.33	0.0367	0.28	$y = 85.07 - 0.04098x$
Quadratic	0.50	0.37	0.0639	0.23	$y = 29,061 - 28.96x + 0.007215x^2$
Cubic	0.54	0.34	0.1257	0.21	$y = -13,814,792 + 20,695x - 10.33x^2 + 0.00172x^3$
Quartic	0.61	0.35	0.1702	0.18	$y = -14,407,445,048 + 28,750,586x - 21,515x^2 + 7.156x^3 - 0.0008924x^4$

Table 13. Regressions-fiscal year vs. rice EROI.

Regression	r ² value	Adjusted r ² value	p-value	Residual sum of squares	Equation
Linear	0.01	- 0.10	0.7245	3.77	$y = 48.9 - 0.02243x$
Quadratic	0.82	0.77	0.0011	0.70	$y = 240,191 - 239.7x + 0.0598x^2$
Cubic	0.86	0.80	0.0023	0.54	$y = -40,899,374 + 61,347x - 30.67x^2 + 0.005112x^3$
Quartic	0.89	0.81	0.0054	0.43	$y = -25,390,309,936 + 50,659,130x - 37,903x^2 + 12.6x^3 - 0.001572x^4$

3.2. Crop Output

Both the rice and wheat crops follow a similar pattern of decreasing output at the beginning of the study period followed by a steady increase during the rest of the study period. Over the course of the study period, wheat output increased by 34.6% (31.9% if measured from 2002), and rice by 48.2% (80.3% if measured from 2002) (Figure 3).

Figure 3. Energy output from wheat and rice produced in Pakistan and the percentage change in the output from the previous year (1999–2009). Percentage change figures at the top of the figure are for wheat and in the middle of the figure for rice.

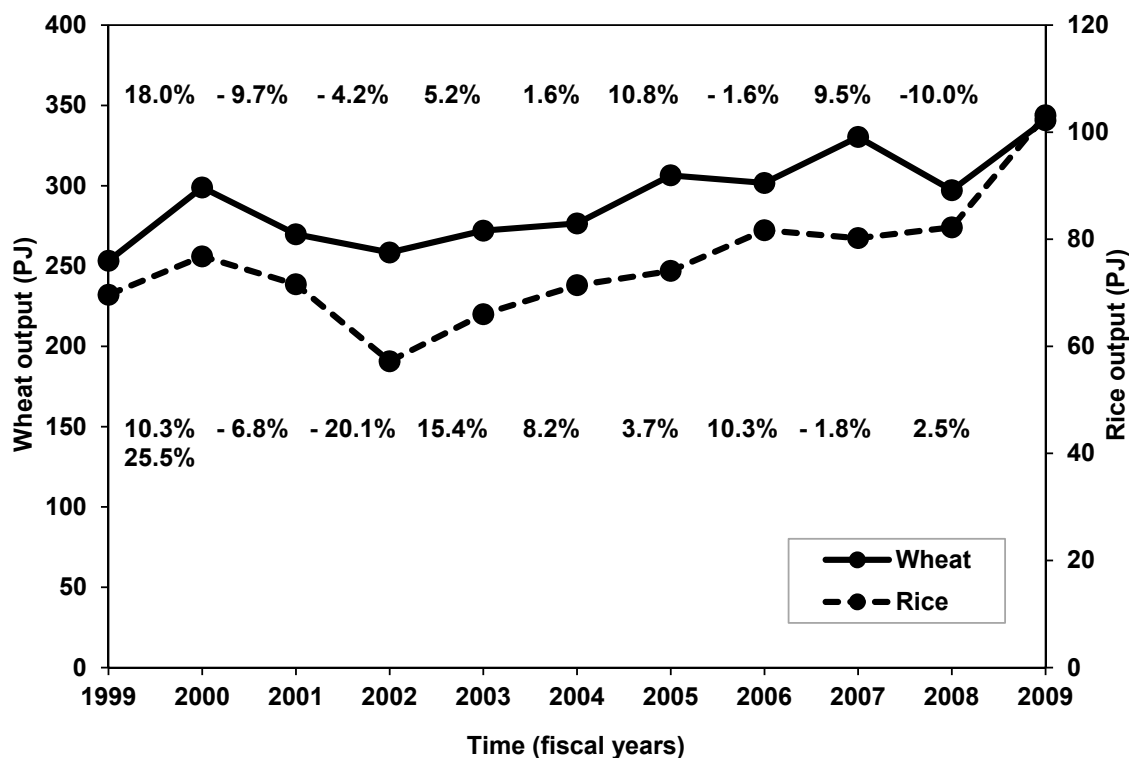

3.3. Crop Input

The energy input trend to both crops follows a similar pattern. The inputs to both crops increased from 1999 to 2005 at different rates over the length of the study period. Inputs to wheat increased by 41.7% and by 41.0% for rice between 1999 and 2009. The sharpest increases in inputs to wheat occurred in 2005 and in 2004 to rice. It is noteworthy that after 2005, the inputs to wheat increased gradually, but for rice, decreased overall.

3.3.1. Individual Inputs

Nitrogen fertilizer is the largest input to wheat, on average accounting for almost 53% of total inputs. Combined, P and K account for just 1.7% of total inputs. Nitrogen fertilizer is also the largest input to rice, on average accounting for 32.2% of total inputs. A major difference between the two crops is in their usage of insecticide, which, on rice accounts for an average 17.1% of all inputs. The corresponding figure for wheat is just 0.3%.

On wheat, seed is the second largest input at 17.9%, followed by tractor diesel at 9.1%, and tube well diesel at 6.6%. In the case of rice, the second largest input is tube well diesel at 20%, followed by insecticide at 17.1%, tube well electricity at 12.5%, and labor at seven percent (Figures 4 and 5).

Figure 4. Energy inputs to wheat (PJ on primary y-axis) and wheat output (PJ on secondary y-axis) from 1999 to 2009. The figures on the bars are the energy inputs in PJ. “TW” is tube well.

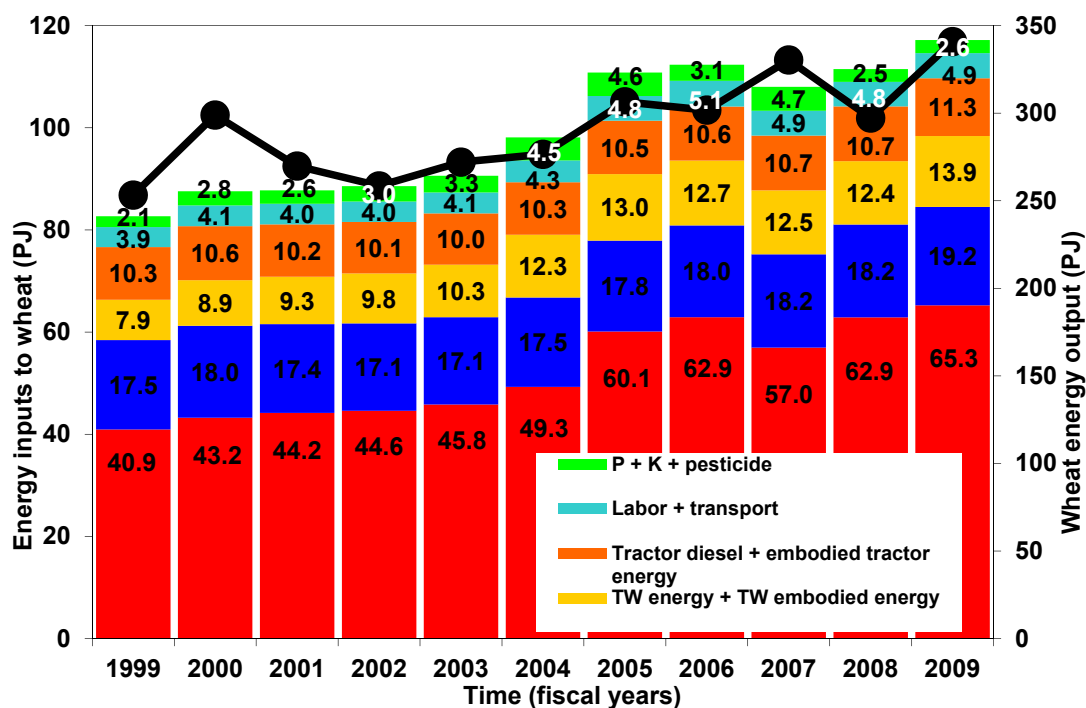
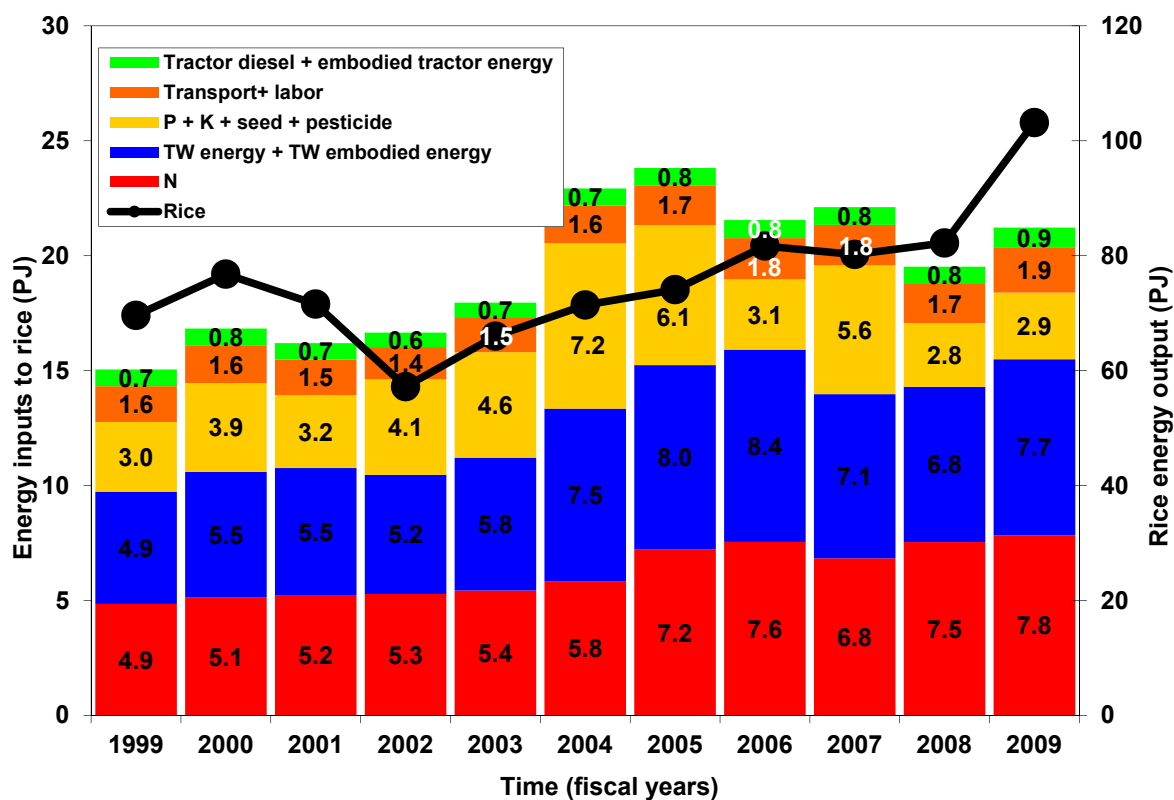

Figure 5. Energy inputs to rice (PJ on primary y-axis) and rice output (PJ on secondary y-axis) from 1999 to 2009. The figures on the bars are the energy inputs in PJ. “TW” is tube well.



3.4. Per-Hectare Results

Presenting energy inputs and outputs on a per-hectare basis allows a direct comparison between wheat and rice. Wheat's per-hectare energy output was consistently greater than that of rice, on average by a factor of 1.1. Many of its inputs are also greater, including N fertilizer by an average factor of 2.5, seed by an average factor of 2.8, and tractor diesel by an average factor of 4.2. Conversely, rice had several inputs that were greater than corresponding ones on wheat. Rice is more insecticide intensive by an average factor of 44.6. It is also more labor intensive by an average factor of 2.1. Finally, as rice is more water-intensive than wheat, its tube well diesel figure was greater by an average factor of two.

Examining percentage changes in major inputs in relation to percentage changes in outputs on a per-hectare basis reveals some interesting patterns. It appears that increases in some major inputs do not necessarily translate into increased output. There are numerous instances where a sizable increase in N fertilizer had little, or a negative impact on wheat output. While this is not suggesting a correlation (or the lack thereof) between N fertilizer and output, it certainly merits discussion. Similar observations are made for rice. Large increases in insecticide (specifically 2002, 2004, and 2007) had little impact on output. Often times, large decreases in insecticide appeared to result in better output (2005, 2006, 2008, and 2009; Table 14).

Table 14. Percentage changes in the largest inputs per hectare to wheat and rice, 1999 to 2009.

FY	Wheat		Rice			
	N fertilizer	Output	N fertilizer	TW diesel	Insecticide	Output
1999						
2000	2.7	14.8	1.8	12.0	29.3	6.3
2001	5.7	-6.6	8.1	8.6	-17.8	-1.3
2002	2.5	-2.7	13.4	8.4	65.1	-10.2
2003	3.1	5.6	-2.3	10.0	6.2	9.6
2004	5.2	-0.6	-2.7	25.9	50.0	-2.2
2005	19.9	9.0	20.5	2.8	-20.8	1.3
2006	3.5	-2.6	0.6	1.7	-60.2	6.0
2007	-10.8	7.8	-8.1	-10.2	119.7	-0.3
2008	10.7	-9.7	13.3	-5.6	-57.3	5.2
2009	-1.9	8.4	-11.9	-3.7	-15.1	6.5

The relationship between all per-hectare inputs and per-hectare output also shows some interesting patterns. The 11-year dataset shows that wheat yield is still increasing with rising inputs. Rice, however, shows a gradually declining trend (Figure 6).

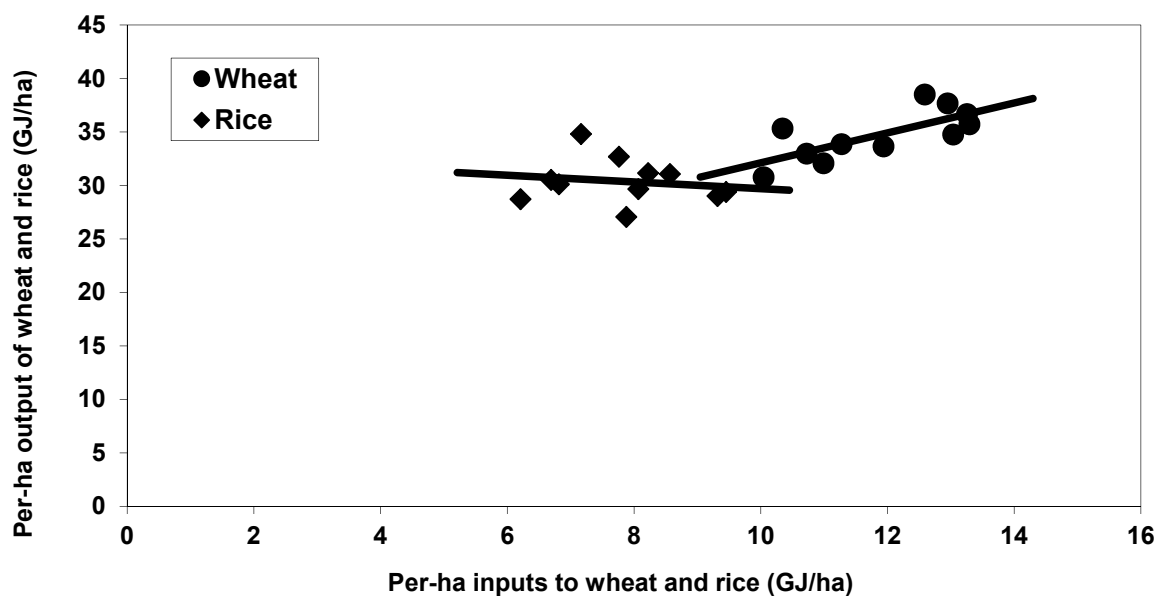
Figure 6. Relation between energy inputs and output for wheat and rice crops in Pakistan from 1999 to 2009.

For wheat per-hectare input against per-hectare output, the linear, quadratic, and quartic regressions were significant (Table 15). None of the regressions were significant in the case of rice (Table 16).

Table 15. Regressions-wheat inputs per hectare vs. wheat output per hectare.

Regression	r ² value	Adjusted r ² value	p-value	Residual sum of squares	Equation
Linear	0.53	0.48	0.0110	26.14	$y = 18.12 + 1.4x$
Quadratic	0.53	0.42	0.0476	26.03	$y = 3.171 + 3.966x - 0.109x^2$
Cubic	0.56	0.37	0.1078	24.61	$y = 706.6 - 178.8x + 15.64x^2 - 0.4504x^3$
Quartic	0.70	0.51	0.0814	16.55	$y = -23,612 + 8,228x - 1,070x^2 + 61.69x^3 - 1.329x^4$

Table 16. Regressions-rice input per hectare against rice output per hectare.

Regression	r ² value	Adjusted r ² value	p-value	Residual sum of squares	Equation
Linear	0.03	-0.08	0.6423	42.20	$y = 32.84 - 0.3137x$
Quadratic	0.14	-0.08	0.5481	37.24	$y = -8.318 + 10.31x - 0.675x^2$
Cubic	0.25	-0.08	0.5525	32.67	$y = -406.4 + 165.2x - 20.55x^2 + 0.8407x^3$
Quartic	0.26	-0.23	0.7162	31.90	$y = -2,023 + 1,019x - 188.2x^2 + 15.37x^3 - 0.4688x^4$

4. Discussion

The EROI concept applied to food crops elucidates the relation between inputs to crops and the crops' response in terms of yield, which provides more information than just looking at total production. Large production figures are better understood when compared with their corresponding input figures. Rice's EROI was consistently greater than wheat's over the timeframe studied. Wheat achieved its highest EROI in 2000, although production and yield were far higher in 2007 and 2009. Production in 2007 was considered a bumper crop. Inputs that year had actually decreased by 3.9%, causing the EROI to increase by almost 14%. Inputs increased steadily throughout the study period (except for 2007's minor decline). Production reached an all-time high in 2009, but so did inputs, resulting in the same EROI as 2002. The trend for output is erratic, but inputs continued to increase, and the EROI showed minor fluctuation around the 1:3 mark. This suggests that external factors such as rainfall and time of planting may have played a role. Indeed, comments on the 2009 figures by Pakistan's Ministry of Food and Agriculture (MINFAL) cited "adequate soil moisture" and "favorable weather conditions (sic)" [9, p. 4]. Similarly, comments on 2007's bumper wheat crop cited "sufficient rains", proper fertilizer use, and weed control [9, p. 4].

These annual comments on production usually speak of increases and decreases in total cropped area and what motivates farmers to increase or decrease their cropped area. A decrease in wheat area is often attributed to delay in sugar cane crushing (thereby delaying the sowing of wheat) and delays in rice harvests due to rains. Increases in wheat area are often attributed to better support prices guaranteed by the government (a minimum price that farmers must receive per unit weight of wheat). It is possible that such incentives may drive farmers to make efforts to increase their per-hectare yields as well. The largest increase in the wheat support price (a 52% increase) occurred in 2009 [9, p. 208].

Inputs to rice production showed a steady increase from 1999 to 2005. During this period, output fluctuated between 27.1 GJ ha^{-1} and 30.1 GJ ha^{-1} . After that, inputs fluctuated, but output continued to increase. As expected, the EROI showed an overall decline between 1999 and 2005, then a sharp rise between 2005 and 2009.

Rice's inputs have always been lower than that of wheat by virtue of both crops' unique requirements and properties. For example, wheat is known to be more tractor intensive than rice. Rice is more labor intensive, which is obviously not associated with as high an energy use value as tractor diesel. Similarly, wheat sowing requires approximately seven times the seed per-hectare than rice does. Rice is also known to be more pesticide intensive than wheat. By government estimates, 23% of all pesticide is used on rice, compared with nine percent on wheat ([22], p. 13). Nitrogen fertilizer is generally among the larger inputs in most agricultural systems and it is true for wheat and rice production in Pakistan and other agricultural systems in this region [46,69].

In explaining the behavior of the two crops, it is appropriate to consider the classical production function which is characterized initially by increasing yields at an increasing rate (stage 1). This stage is followed by decreasing returns per incremental unit of input. The function assumes that a maximum yield is reached during this stage (stage 2). The law of diminishing returns (or the law of variable proportions) prevails in the third stage, which means that increases in inputs result in a leveling-off or even diminishing output increase [87]. By this theory, one may postulate that rice's trend would indicate that little or none of the output is adequately explained by the inputs, and it has already reached a saturation point or asymptote, and is now on the decline (stage 3). Thus, for the sake of argument, it could be stated that if increasing inputs (such as N fertilizer) do not have a noticeable effect on yields, this could mean that land degradation over time requires increasing amounts of chemical fertilizer just to maintain a certain level of output. Of wheat, one may hypothesize that wheat's positive trend means increasing inputs will continue to affect yield positively.

In examining the individual inputs to the two crops, it is clear that wheat (averaging 11.9 GJ ha^{-1}) requires greater energy inputs per hectare than rice (averaging 7.8 GJ ha^{-1}) by an average factor of 1.5. Wheat's yields are also consistently higher than rice's, but by just an average factor of 1.1, but its inputs are also always higher thus resulting in a lower EROI than rice's. It should be noted that rice responded to a relatively small range of input change with greater output and an increase in EROI. Conversely, wheat, which displayed a large range in input change (increase) showed little change in EROI.

Wheat's output-input relation is a positive one, *i.e.*, as inputs increase, so does output. Statistical analysis showed the linear, quadratic, and quartic regressions to be significant. Singh and Singh (1992) observed a linear relationship between wheat yield and its inputs [88]. However, Sidhu *et al.* (2004) found both linear and quadratic fits to be significant [89]. For wheat, N fertilizer exhibited the largest changes over time. It is also the largest input, on average, accounting for 52.6% of inputs. The year 2005 had N fertilizer increasing by almost 20%. Total per-hectare inputs that year increased by 11%, while per-hectare yield increased by 9%. However, in 2007 (the wheat bumper crop year), N fertilizer applied per hectare decreased by 10.8%, total inputs by 5.3%, but yield increased by 7.8%. There is also a strong relationship between wheat yield and per-hectare fertilizer input.

For rice, the situation is different. Overall, increasing per-hectare inputs does not appear to increase yield. The relation is a negative one overall, and also when examined against individual inputs

(N fertilizer, tube well irrigation diesel, and insecticide). In fact, in many instances of large insecticide increases per hectare, rice yield actually suffered. In 2002, insecticide application increased by 65%, but yield decreased by 10.2%. In 2004, application increased by 50%, but yield decreased by 2.2%. Conversely, when insecticide application decreased by 20.8% and 60.2% in 2005 and 2006 respectively, yield increased slightly (1.3% in 2005 and six percent in 2006). Similarly, large decreases in 2008 and 2009 resulted in yield increases. These increases did not translate into the higher production that one might expect from increased fertilizer or from a reduction in pest attacks (which such a large increase in pesticide implies). It should be noted, however, that both fertilizer and pesticide usage on wheat and rice were calculated from crude government percentages of total fertilizer and pesticide usage which are the only data available on these inputs.

There was no significant relation between rice's per-hectare inputs and yield indicating that as more energy is invested in the production of rice in Pakistan, the amount of energy produced per hectare in the crop does not change. The years 2004 and 2005 had the largest per-hectare inputs over the study period (9.3 GJ ha⁻¹ and 9.5 GJ ha⁻¹, respectively), but these were not the years with the highest yields. The input of insecticide was the highest in both these years (2.6 GJ ha⁻¹ and 2.0 GJ ha⁻¹, respectively). Average insecticide usage of 1.4 GJ ha⁻¹ falls to 1.2 GJ ha⁻¹ if these two years are excluded. Nitrogen fertilizer input for rice also increased in 2005 from 2.4 GJ ha⁻¹ to 2.9 GJ ha⁻¹ and maintained the latter figure until 2006. Overall, insecticide had a negative relation with rice yield, whereas N fertilizer had a positive one. It is therefore possible that insecticide application to rice is at least partly responsible for the overall decreasing output-input trend.

5. Conclusion

This analysis adds several missing links that economic analyses tend to ignore. It utilizes real energy units which are not dependent on manmade constructs such as prices and markets. It accounts for elements such as labor energy, embodied energy, and energy utilized in electricity generation. These elements add rigor to the analysis.

Wheat's EROI continued to decline over the entire study period except in 2003 and 2007 where input increases from the previous years were low, but yields were anomalously high. Rice's EROI changes constantly, reflecting widespread differences in input usage styles across the country.

Wheat and rice's output-input trends are considerably different from one another. Little or none of rice's output is adequately explained by its inputs indicating that output may have reached a saturation point. For example, large increases in insecticide in certain years did not appear to have an impact on production. Wheat's response, however, shows that increasing inputs still affect output positively.

Resource scarcity and use are very real concerns for Pakistan. This analysis shows how and where energy is used in Pakistan's wheat and rice production. In some instances, increasing energy inputs did not translate into an equivalent increase in yields, such as in the case of rice. Wheat, on the other hand, continues to respond to increasing inputs. However, further studies may be able to identify and state more clearly what inputs are providing the greatest benefits and those that are not. Energy inefficiencies should be considered to ensure that energy is not wasted in these systems as the demand for these resources increases and they become more scarce.

References and Notes

1. The World Factbook. *South Asia: Pakistan*; Central Intelligence Agency: Washington, DC, USA, 2010a. Available online: <https://www.cia.gov/library/publications/the-world-factbook/geos/pk.html> (accessed on 22 September 2010).
2. World Bank. *Population, Total*; 2010. Available online: http://data.worldbank.org/indicator/SP.POP.TOTL?cid=GPD_1 (accessed on 9 August 2010).
3. The World Factbook. *Country Comparison: Distribution of Family Income - Gini Index*; Central Intelligence Agency: Washington, DC, USA, 2010b. Available online: <https://www.cia.gov/library/publications/the-world-factbook/rankorder/2172rank.html?countryName=Pakistan&countryCode=pk®ionCode=sas&rank=109#pk> (accessed on 22 September 2010).
4. Government of Pakistan. *Pakistan Economic Survey 2009–2010*; Finance Division, Economic Advisor's Wing: Islamabad, Pakistan, 2010a.
5. Government of Pakistan. *Pakistan Economic Survey 2008–2009*; Finance Division, Economic Advisor's Wing: Islamabad, Pakistan, 2009a.
6. Government of Pakistan. *Pakistan Economic Survey 2006–2007*; Finance Division, Economic Advisor's Wing: Islamabad, Pakistan, 2007.
7. International Rice Research Institute (IRRI). *Frequently Asked Questions*; 2007. Available online: <http://www.irri.org/about/faq1.asp> (accessed on 3 October 2010).
8. Indexmundi. *Wheat Production by Country in 1000 MT*; 2009. Available online: <http://www.indexmundi.com/agriculture/?commodity=wheat&graph=production> (Accessed on 25 September 2010).
9. Government of Pakistan. *Agricultural Statistics of Pakistan 2008–2009*; Ministry of Food, Agriculture, and Livestock: Economic, Trade, and Investment Wing: Islamabad, Pakistan, 2010b.
10. Dowswell, C.R. *Wheat Research and Development in Pakistan*; Pakistan Agricultural Research Council/CIMMYT Collaborative Program: Islamabad, Pakistan/Mexico DF, Mexico, 1989.
11. MacLean, J.L., Dawe, D.C., Hardy, B., Hettel, G.P., Eds.; *Rice Almanac*; International Rice Research Institute (IRRI): Manila, Philippines, 2002.
12. World Health Organization. *El Niño and its Health Impact – Fact Sheet No. 192*; 2000. Available online: <http://www.who.int/mediacentre/factsheets/fs192/en/> (accessed on 7 December 2009).
13. Food and Agriculture Organization. *The Impact of El Niño and Other Weather Anomalies on Crop Production in Asia*; 1997. Available online: <http://www.fao.org/docrep/004/w6413e/w6413e00.HTM> (accessed on 7 December 2009).
14. Government of Pakistan. *Pakistan Statistical Yearbook 2008*; Federal Bureau of Statistics: Islamabad, Pakistan, 2008.
15. Food and Agriculture Organization of the United Nations. *Fertilizer Use by Crop in Pakistan*; FAO: Rome, Italy, 2004.
16. International Fertilizer Industry Association, International Fertilizer Development Center, and Food and Agriculture Organization of the United Nations. *Fertilizer Use by Crop = Utilisation des Engrais par Culture = Utilización de Fertilizantes por Cultivo*; Food and Agriculture Organization of the United Nations: Rome, Italy, 1992.

17. Food and Agriculture Organization of the United Nations, International Fertilizer Development Center, and International Fertilizer Industry Association. *Fertilizer Use by Crop = Utilisation des Engrais par Culture = Utilización de Fertilizantes por Cultivo*; Food and Agriculture Organization of the United Nations, Rome, Italy, 1994.
18. Food and Agriculture Organization of the United Nations, International Fertilizer Development Center, and International Fertilizer Industry Association. *Fertilizer Use by Crop = Utilisation des Engrais par Culture = Utilización de Fertilizantes por Cultivo*; Food and Agriculture Organization of the United Nations: Rome, Italy, 1996.
19. Food and Agriculture Organization of the United Nations, International Fertilizer Development Center, and International Fertilizer Industry Association. *Fertilizer Use by Crop = Utilisation des Engrais par Culture = Utilización de Fertilizantes por Cultivo*; Food and Agriculture Organization of the United Nations: Rome, Italy, 1999.
20. Food and Agriculture Organization of the United Nations, International Fertilizer Development Center, and International Fertilizer Industry Association. *Fertilizer Use by Crop = Utilisation des Engrais par Culture = Utilización de Fertilizantes por Cultivo*; Food and Agriculture Organization of the United Nations: Rome, Italy, 2002.
21. Khan, M.H. *Agriculture in Pakistan: Change and Progress 1947–2005*; Vanguard: Lahore, Pakistan, 2006.
22. National Fertilizer Development Centre (NFDC). *Survey on Pesticides Use and its Impact*; Survey Report, NFDC Publication No. 2/2002; Planning and Development Division, National Fertilizer Development Centre: Islamabad, Pakistan, 2002.
23. Khan, D. An Investigation into the Level of Underemployment in [the] Agricultural Sector of [the] Peshawar Valley. PhD dissertation; Department of Agricultural Economics, NWFP Agricultural University, Peshawar, Pakistan, 2007.
24. FAOSTAT. *ResourceSTAT - Machinery*, Country: Pakistan; Year 1961–2007; Item: Agricultural tractors; Element: in use; 2009. Available online: <http://faostat.fao.org/site/576/DesktopDefault.aspx?PageID=576#ancor> (accessed on 27 November 2010).
25. Lal, R.; Hobbs, P.R.; Uphoff, N.; Hansen, D.O. *Sustainable Agriculture and the International Rice-wheat System*; Marcel Dekker, Inc: New York, NY, USA, 2004.
26. World Bank. *Pakistan - Country Water Resources Assistance Strategy: Water Economy Running Dry, Report Number 34081*; World Bank: Islamabad, Pakistan, 2005.
27. Shapouri, H.; Salassi, M. *The Economic Feasibility of Ethanol Production from Sugar in the United States*; United States Department of Agriculture: Washington, DC, USA, 2006.
28. Murphy, D.; Hall, C.A.S.; Powers, B. New perspective on the energy return on (energy) investment of corn ethanol. *Environ. Dev. Sustain.* **2010**, doi:10.1007/s10668-010-9255-7.
29. Evenson, R.E. The green revolution and the gene revolution in Pakistan: Policy implications. *Pak. Dev. Rev.* **2005**, *44*, 359-386.
30. Ahmad, I.; Hussain, S.A.; Zahid, M.S. Why the green revolution was [a] short run phenomena in the development process of Pakistan: A lesson for [the] future. *J. Rural Dev. Adm.* **2004**, *XXXV*, 89-108.
31. Borlaug, N. The green revolution, peace, and humanity. In *Nobel Lectures, Peace 1951–1970*; Haberman, F.W., Ed.; Elsevier Publishing Company: Amsterdam, The Netherlands, 1972.

32. Wheeler, C.W. *Pakistan's Green Revolution*, DACNews; 2007. Available online: http://www.oecd.org/document/57/0,3343,en_2649_33721_39575353_1_1_1_1,00.html (accessed on 20 May 2009).
33. Crosson, P.R.; Brubaker, S. *Resource and Environmental Effects of U.S. Agriculture*; Resources for the Future: Washington, DC, USA, 1982.
34. Stanhill, G. *Energy and Agriculture*; Advanced Series in Agricultural Sciences, 14; Springer: Berlin, Germany, 1984.
35. Leach, G.; Jarass, L.; Obermair, G.; Hoffman, L. *Energy and Growth: A Comparison of 13 Industrial and Developing Countries*; Butterworths: London, UK, 1986.
36. Pimentel, D.; Dazhong, W.; Giampietro, M. Technological Changes in Energy Use in U.S. Agricultural Production. In *Agroecology*, Gliessman, S.R., Ed.; Springer: New York, NY, USA, 1990.
37. Conforti, P.; Giampietro, M. Fossil energy use in agriculture: an international comparison. *Agric. Ecosyst. Environ.* **1997**, *65*, 231-243.
38. Hall, C.A.S.; Cleveland, C.J.; Kaufmann, R. *Energy and Resource Quality: The Ecology of the Economic Process*; Wiley: New York, NY, USA, 1986.
39. Ehrlich, P.R.; Ehrlich, A.H.; Daily, G.C. Food security, population, and environment. *Popul. Dev. Rev.* **1993**, *19*, 1-32.
40. Giampietro, M. Socioeconomic constraints to farming with biodiversity. *Agric. Ecosyst. Environ.* **1997**, *62*, 145-67.
41. Jameel, M. *Energy for Agriculture in Pakistan*; International Institute for Applied Systems Analysis: Laxenburg, Austria, 1982.
42. Khan, M.A.; Zafar, J.; Bakhsh, A. Energy requirement and economic analysis of sugarcane production in Dera Ismail Khan district of Pakistan. *Gomal Univ. J. Res.* **2008**, *24*, 72-82.
43. Khan, M.A. Singh, G. Energy inputs and crop production in Western Pakistan. *Energy* **1996**, *21*, 45-53.
44. Khan, M.A.; Singh, G. Energy inputs and potential for agricultural production in Western Pakistan. *Agric. Syst.* **1997**, *54*, 341-56.
45. Mandal, K.G.; Saha, K.P.; Ghosh, P.K.; Hati, K.M.; Bandyopadhyay, K.K. Bioenergy economic analysis of soybean-based crop production systems in central India. *Biomass Bioenergy* **2002**, *23*, 337-345.
46. Singh, H.; Singh, A.K.; Kushwaha, H.L.; Singh, A. Energy consumption pattern of wheat production in India. *Energy* **2007**, *32*, 1848-1854.
47. Nassiri, S.M.; Singh, S. Study on energy use efficiency for paddy crop using data envelopment. *Appl. Energy* **2009**, *86*, 1320-1325.
48. Fluck, R.C.; Baird, C.D. *Agricultural Energetics*; AVI Pub. Co.: Westport, CT, USA, 1980.
49. Hall, C.A.S.; Balogh, S.; Murphy, D.J. What is the minimum EROI that a sustainable society must have? *Energies* **2009**, *2*, 25-47.
50. Government Accountability Office. *Net Energy Analysis: Little Progress and Many Problems*, EMD-77-57, Report to the Energy Research and Development Administration; Government Accountability Office: Washington DC, USA, 1977.

51. McKetta, J.J. *Encyclopedia of Chemical Processing and Design 19 - Energy, Costing Thermal Electric Power Plants to Ethanol*; Dekker: New York, NY, USA, 1983.
52. Klass, D.L. *Biomass for Renewable Energy, Fuels, and Chemicals*; Academic Press: San Diego, CA, USA, 1998.
53. Government Accountability Office. *DOE Funds New Energy Technologies Without Estimating Potential Net Energy Yields*, GAO/IPE-82-1, Report to the President of the Senate and the Speaker of the House of Representatives. Government Accountability Office: Washington, DC, USA, 1982.
54. Cleveland, C. *Net Energy Analysis*; 2008. Available online: http://www.eoearth.org/article/Net_energy_analysis (accessed on 19 March 2009).
55. Leach, G. *Energy and Food Production*; IPC Science and Technology Press: Guildford, UK, 1976.
56. Refsgaard, K.; Halberg, N.; Kristensen, E.S. Energy utilization in crop and dairy production in organic and conventional livestock production systems. *Agric. Syst.* **1998**, *57*, 599-630.
57. United States Department of Agriculture. *USDA National Nutrient Database for Standard Reference*; 2009. Available online: <http://www.nal.usda.gov/fnic/foodcomp/search/> (accessed on 25 November 2009).
58. Cheema, M.S.; Ali, L.; Akhtar, M. *Wheat Following the Cotton and Rice-based Cropping System in Pakistan*; USDA Annual Wheat Newsletter, Items from Pakistan; 2002. Available online: <http://wheat.pw.usda.gov/ggpages/awn/48/Textfiles/PAKISTAN.html> (accessed on 12 November 2009).
59. Akhter, M.; Ramzan, M.; Ahmad, M. *News Channel: Maximizing Rice Yield*; 2007. Available online: <http://www.pakissan.com/english/news/newsDetail.php?newsid=14589> (accessed on 22 June 2009).
60. Government of Pakistan. *Pakistan Statistical Yearbook 2009*; Federal Bureau of Statistics: Islamabad, Pakistan, 2009b.
61. Patzek, T.W. Thermodynamics of the corn-ethanol biofuel cycle, web version: updated July 22, 2006. *Critical Reviews in Plant Sciences*; **2004**, *23*, 519-567. Available online: <http://petroleum.berkeley.edu/papers/patzek/CRPS416-Patzek-Web.pdf> (accessed on 4 August 2008).
62. Pimentel, D. Ethanol fuels: Energy balance, economics, and environmental impacts are negative. *Nat. Resour. Res.* **2003**, *12*, 127-134.
63. Wang, M.; Saricks, C.; Wu, M. *Fuel-cycle Fossil Energy Use and Greenhouse Gas Emissions of Fuel Ethanol Produced from U.S. Midwest Corn*; Report sponsored by the Illinois Department of Commerce and Community Affairs; Argonne National Laboratory, Center for Transportation Research: Argonne, IL, USA, 1997.
64. Shapouri, H.; Duffield, J.A.; Wang, M. *The Energy Balance of Corn Ethanol: An Update*; Agricultural Economic Report, No. 814; Department of Agriculture, Office of the Chief Economist: Washington, DC, USA, 2002.
65. Tzilivakis, J.; Warner, D.J.; May, M.; Lewis, K.A.; Jaggard, K. An assessment of the energy inputs and greenhouse gas emissions in sugar beet (*Beta vulgaris*) production in the UK. *Agric. Syst.* **2005**, *85*, 101-119.

66. Green, M. Energy in Pesticide Manufacture, Distribution, and Use. In *Energy in Plant Nutrition and Pest Control*, Helsel, Z.R., Ed.; Elsevier: Amsterdam, The Netherlands, 1987; Volume 7.
67. Ahmad, S.; Martini, R.P. *Agricultural Policy Analysis in Pakistan: Illustrations in the Use of the Policy Analysis Matrix*; Lahore University of Management Sciences (LUMS), Centre for Management and Economic Research (CMER): Lahore Cantt, Pakistan, 2000; Working Paper No. 00-27.
68. Ajmal, M. *Personal Communication*; The Network for Consumer Protection: Islamabad, Pakistan, 2009.
69. Ozkan, B.; Akcaoz, H.; Fert, C. Energy input–output analysis in Turkish agriculture. *Renew. Energy* **2004**, *29*, 39-51.
70. Government of Pakistan. *Pakistan Agricultural Machinery Census 2004*; Agricultural Census Organization, Statistics Division: Lahore, Pakistan, 2004.
71. Hoyer Tractor Parts. *Additional Help*; 2006. Available online: <http://www.hoyetractor.com/whomakes.htm> (accessed on 28 June 2009).
72. Quick, G.R. *The Compact Tractor Bible*; Voyageur Press: St. Paul, MN, USA, 2006.
73. Stout, B.A. *Handbook of Energy for World Agriculture*; Elsevier: New York, NY, USA, 1991.
74. Bakht, G.K.; Ahmadi, H.; Akram, A.; Karimi, M. Determination of optimum life (economic life) for Mf285 tractor: A case study in center region of Iran. *American-Eurasian J. Agric. Environ. Sci.* **2008**, *4*, 81-85.
75. Smil, V. *General Energetics: Energy in the Biosphere and Civilization*; Wiley: New York, NY, USA, 1991.
76. Nazir, M.S. *Crop Production*; National Book Foundation: Islamabad, Pakistan, 1994.
77. Hydrocarbon Development Institute of Pakistan. *Pakistan Energy Yearbook 2009*; Ministry of Petroleum and Natural Resources: Islamabad, Pakistan, 2010.
78. Hydrocarbon Development Institute of Pakistan. *Pakistan Energy Yearbook 2004*; Ministry of Petroleum and Natural Resources: Islamabad, Pakistan, 2004.
79. Hydrocarbon Development Institute of Pakistan. *Pakistan Energy Yearbook 2005*; Ministry of Petroleum and Natural Resources: Islamabad, Pakistan, 2005.
80. Hydrocarbon Development Institute of Pakistan. *Pakistan Energy Yearbook 2006*; Ministry of Petroleum and Natural Resources: Islamabad, Pakistan, 2006.
81. Hydrocarbon Development Institute of Pakistan. *Pakistan Energy Yearbook 2008*; Ministry of Petroleum and Natural Resources: Islamabad, Pakistan, 2009.
82. Woodbank Communications Ltd. *Hydroelectric Power*; 2005. Available online: http://www.mpoweruk.com/hydro_power.htm (accessed on 3 October 2010).
83. World Nuclear Association. *Nuclear Power Reactors - The Power Rating of a Nuclear Power Reactor*; 2011. Available online: <http://www.world-nuclear.org/info/inf32.html> (accessed on 6 June 2011).
84. Batty, J.C.; Keller, J. Energy Requirements for Irrigation. In *Handbook of Energy Utilization in Agriculture*, Pimentel, D., Ed.; CRC Press: Boca Raton, FL, USA, 1980.
85. Basant Products. *Centrifugal Water Pumpset*; 2006. Available online: <http://www.vidhataindia.com/pump.htm> (accessed on 31 July 2009).

86. Analyze-it®, version 2.22; <http://www.analyse-it.com/>; add-in software for statistical analysis in Microsoft Excel®; Analyze-it Software, Ltd.: Leeds, UK, 2010.
87. McConnell, D.J.; Dillon, J.L. *Farm Management for Asia: A Systems Approach*; *FAO Farm Systems Management Series - 13*; Food and Agriculture Organization of the United Nations: Rome, Italy, 1997. Available online: <http://www.fao.org/docrep/w7365e/w7365e00.htm#Contents> (accessed on 9 August 2009).
88. Singh, S.; Singh, G. Energy input and crop yield relationship to four major crops of northern India. *Agricultural Mechanization in Asia, Africa, and Latin America (AMA)* **1992**, *23*, 57.
89. Sidhu, H.S.; Singh, S.; Singh, T.; Ahuja, S.S. Optimization of energy usage in different crop production systems. *Agric. Eng.* **2004**, *85*, paper 01.

© 2011 by the authors; licensee MDPI, Basel, Switzerland. This article is an open access article distributed under the terms and conditions of the Creative Commons Attribution license (<http://creativecommons.org/licenses/by/3.0/>).

Article

Energy Return on Energy Invested (EROI) for the Electrical Heating of Methane Hydrate Reservoirs

Roberto Cesare Callarotti

Universidad del Turabo, 00778 Gurabo, Puerto Rico; E-Mail: robercallarotti@gmail.com

Received: 10 June 2011; in revised form: 1 August 2011 / Accepted: 5 August 2011 /

Published: 7 November 2011

Abstract: We model the low frequency electrical heating of submarine methane hydrate deposits located at depths between 1000 and 1500 m, and determine the energy return on energy invested (EROI) for this process. By means of the enthalpy method, we calculate the time-dependent heating of these deposits under applied electrical power supplied to a cylindrical heater located at the center of the reservoir and at variable depths. The conversion of the produced water to steam is avoided by limiting the heater temperature. We calculate the volume of methane hydrate that will melt and the energy equivalent of the gas thus generated. The partial energy efficiency of this heating process is obtained as the ratio of the gas equivalent energy to the applied electrical energy. We obtain EROI values in the range of 4 to 5, depending on the location of the heater. If the methane gas is used to generate the electrical energy required in the heating (in processes with a 33% efficiency), the effective EROI of the process falls in the range of 4/3 to 5/3.

Keywords: EROI; methane hydrates; electrical heating; electromagnetic heating; moving boundary problems; enthalpy method

1. Introduction

Methane hydrates are water-methane compounds which are present under the proper temperature and pressure conditions either at the bottom of the sea close to continental shelves or in the subsoil [1-3]. They are important due to the very large amounts of methane they contain [4,5]. By 1999 Japan had already started very significant efforts to produce gas from land and oceanic deposits [6].

In view of the importance of avoiding methane hydrate plugs in oil production pipes, we extended our work on the electromagnetic heating of petroleum [7] to the microwave heating of methane hydrate plugs [8,9] and to the low frequency (50–60 Hz) heating of reservoirs. Here we present

additional results related to this low frequency heating, with special attention given to the energy return on energy invested (EROI) of the process.

In Figure 1 we indicate the stability conditions for a methane hydrate deposit situated at the bottom of the sea, at depths between 1000 and 1500 m. In Figure 2 we show the geometry used in the model: (a) the reservoir is assumed to have cylindrical symmetry; (b) a cylindrical electrical heater is located at the center of the reservoir (at different depths); (c) a water temperature of 2 °C is assumed at the top of the reservoir; (d) the temperature along the sides of the deposit (and at the bottom) is determined by the geothermal gradient of 40 °C/Km. The results of the model are obtained in relation to a cylindrical coordinate system (R,Z) whose origin is located at the center of the top of the reservoir.

When the heater is turned on, different regions of the reservoir will heat up and dissociate when they reach the melting temperature of 22 °C, thus liberating methane gas. The key objective of this paper is the determination of the ratio of the energy equivalent of the methane given off in the molten regions, to the electrical energy supplied. We feel that knowing this partial efficiency factor is essential for establishing the theoretical feasibility of electrical heating schemes of methane hydrate (MH).

In Section 2 we determine the temperature variations in the hydrate region due to the applied power distribution. In Section 3 we present the results for the energy efficiencies obtained for different heaters and heater locations in the reservoir. Finally, we present conclusions derived from the present work with recommendations for future extensions.

Figure 1. Conditions for the existence of methane hydrate deposits in porous sediments below the sea surface: shaded region indicate methane hydrate (MH) deposits. The dotted curve line indicates the phase transition between the solid and the (gas + liquid) regions. The continuous lines indicate the temperature gradients in the seabed and in the water.

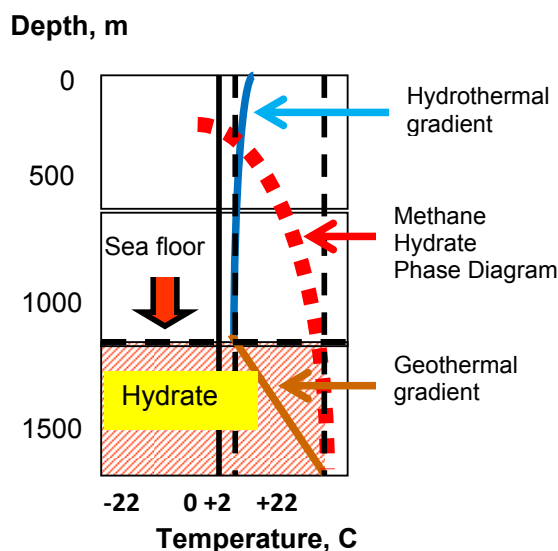
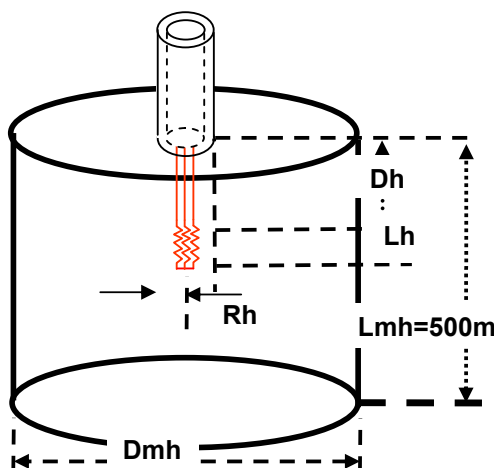

Figure 2. The system: A surface low frequency (50–60 Hz) electrical source is connected by cables (located inside cross-section of a circular pipe) to an electrical heater located inside a methane hydrate reservoir. R_h is the heater radius, L_h the length of the heater, D_h the depth of the heater, D_{mh} the diameter of the reservoir, and L_{mh} the reservoir length.



2. Temperature Distribution in the MH Deposits

The heater shown in Figure 2 is supplied by low frequency (50–60 Hz) electrical energy from a surface power source, transferred to the bottom via conventional cables located inside a production pipe—in the same scheme used for the high voltage (2000 V) supply to submersible pumps used in heavy oil production.

The heater pipe is assumed to have a radius of 0.1524 m (6 inches), and is located at the center of the cylindrical MH reservoir. In the calculations, the methane region is considered to have up to 400 times the radius of the heater (6.1 m) and a thickness of 500 m. As the hydrate melts, the surface separating the solid from the liquid plus gas region will move outwardly from the power source. This moving boundary heat transfer problem (a Stefan problem) can be solved numerically by several special heat transfer methods outlined by Chun-Pyo [10]. The details of the numerical solution for our geometry are given in reference [9].

The values that we used for the different material properties [11,12] are:

MH: latent heat = 438540 joules/kg

MH specific heat = 2108 joules/(kg.K)

MH density = 913 kg/(m³)

MH thermal conductivity = 0.5 watts/(m.K)

Water specific heat = 4187 joules/(kg.K)

Water density = 1000 kg/(m³)

Water thermal conductivity = 0.58 watts/(m.K)

Copper specific heat = 385 joules/(kg.K)

Copper density = 8920 kg/(m³)

Copper thermal conductivity = 401 watts/(m.K)

By turning the heater off, the temperature of the heater is maintained at a temperature below a selected maximum temperature ($T_{max} = 200\text{ }^{\circ}\text{C}$) in order to avoid temperatures that would vaporize the water produced from the MH dissociation. Thus the only gas produced is the methane. At depths of 1000 m the pressure is close to 10^7 pascals corresponding to a temperature of evaporation of some $300\text{ }^{\circ}\text{C}$.

Figure 3 and Figure 4 show how the temperature varies inside the reservoir as time progresses.

Figure 3. Temperature inside the reservoir $T(R, Z = 25\text{ m}, t)$ vs. R at different times. Melting temperature = $22\text{ }^{\circ}\text{C}$. A 30 KW heater is located on top of reservoir (radius = 0.1524 m, length = 75 m, $T_{max} = 200\text{ }^{\circ}\text{C}$).

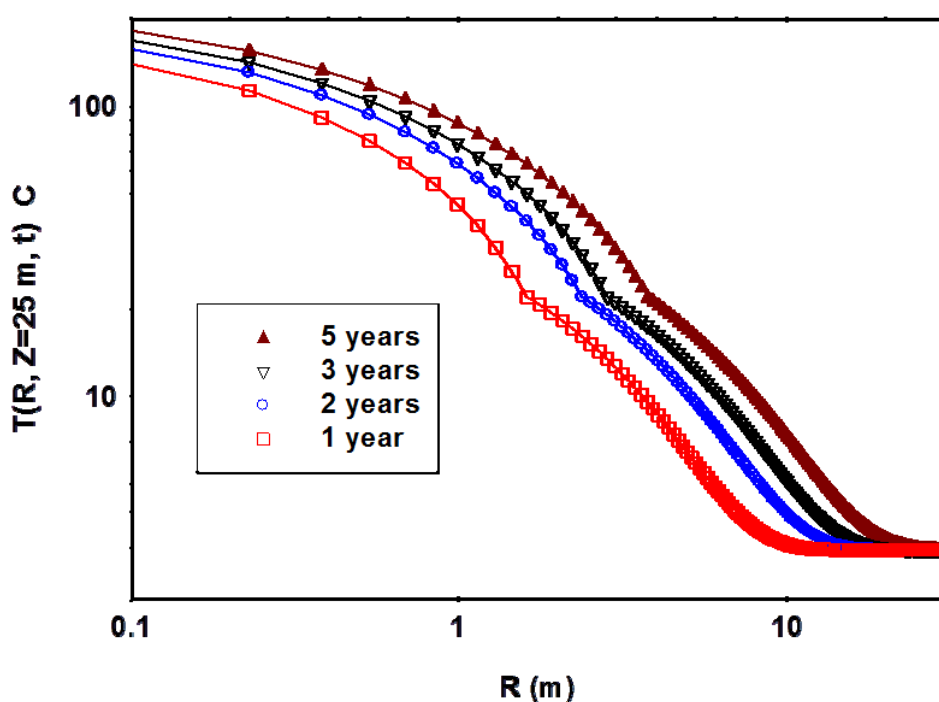

3. Energy Efficiencies at Different Input Power Levels

In this section we present the results of the equivalent energy corresponding to the volumes of methane hydrate that melt at $22\text{ }^{\circ}\text{C}$ in different parts of the reservoir. This equivalent energy is taken to be of the order of 6.1×10^9 joules for each cubic meter of methane hydrate. We determine this value in the following manner:

- (1) One cubic meter of methane hydrate yields 160–170 cubic meters of methane at standard temperature and pressure (STP $0\text{ }^{\circ}\text{C}$ and 1 atm)
- (2) Measurements of the heat of combustion of methane [13] yield a value of 8.906×10^5 joules/mol corresponding to 3.868×10^7 joules/ m^3 of methane. This value closely agrees with an energy content of 1000 BTU per cubic foot, well in the range of the 500–1000 BTU per cubic foot reported in the literature for natural gas [14].
- (3) Thus 1 cubic meter of methane hydrate producing 160 m^3 of methane gas yields an equivalent energy of 6.1×10^9 joules.

Figure 4. Temperature inside the reservoir $T(R, Z, t = 1 \text{ year})$ vs. Z at different R values. Melting temperature = 22 °C. A 30 KW heater is located on top of reservoir (radius = 0.1524 m, length = 75 m, $T_{\text{max}} = 200 \text{ °C}$).

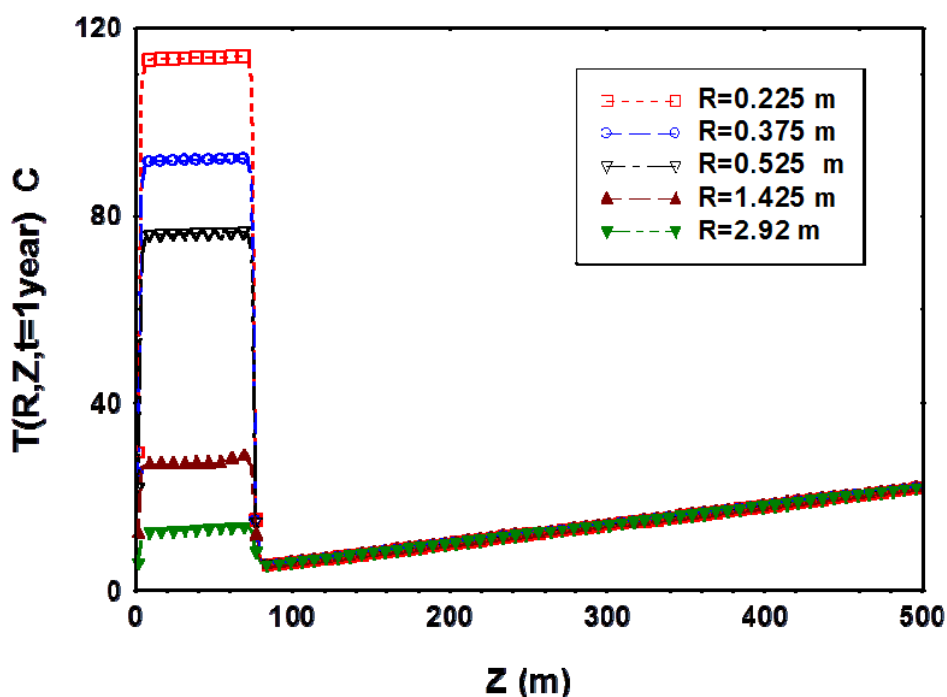

In the following figures we show the results given by our heat transfer model for the energy efficiency of the process. We define this EROI as the ratio of the equivalent energy of the methane separated (in those reservoir sections where the temperature exceeds 22 °C), divided by the electrical energy applied.

As time increases, the applied electrical energy will increase while the energy gain decreases, as the available MH volume decreases. When all the MH deposit has melted, no further energy associated to the methane gas will be available, and the energy efficiency will be zero. This is evidenced in Figure 5 where the results over a 50 year time span are shown.

The results show that a heater located at the top is less efficient than a heater located deeper in the reservoir. This is because of the 2 °C boundary condition which is maintained at the top of the reservoir.

Figure 6 shows the results for a five year heating span, with an applied power of 30 KW, with 100 m long heaters located at the top (EROI \approx 3.7), midway down the reservoir (EROI \approx 4.6), and down at the bottom of the reservoir (EROI \approx 5.4).

Important information about the heating process of methane hydrate reservoirs can be obtained by examining the plots of the time averaged energy input and the energy gain vs. the length of different heaters located at the top of the reservoir, for different levels of applied electrical power. The results are shown in Figures 7 and 8.

Figure 5. Energy gain over a 50 year period, for a 30 KW, 100 m long heater located at the top of the reservoir and at a depth of 200 to 300 m.

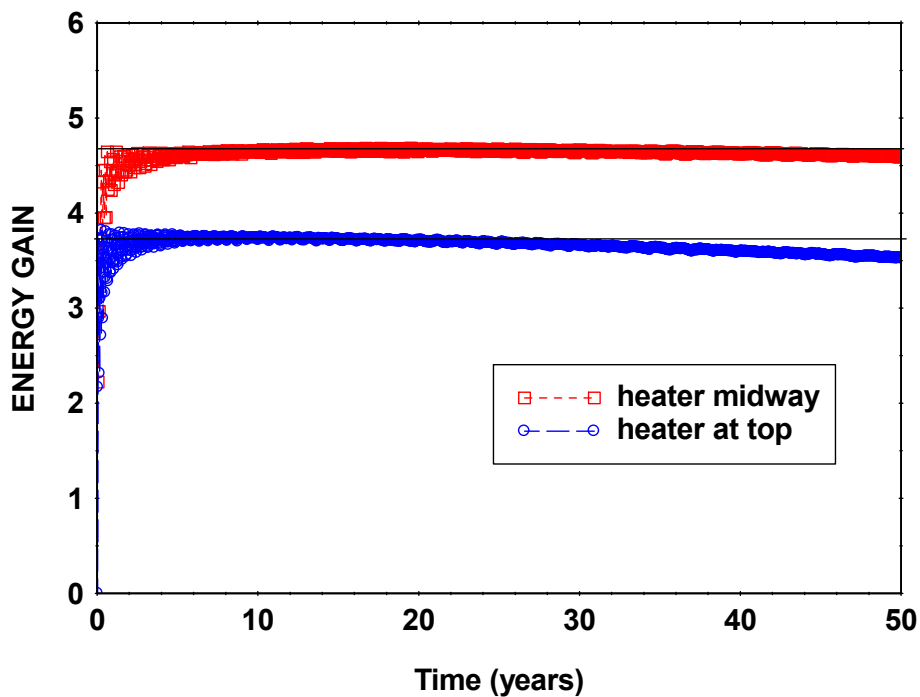

Figure 6. Energy gain over a 5 year period, for a 30 Kw, 100 m long heater located at the bottom of the reservoir, at a depth between 200 and 300 m, and at the top.

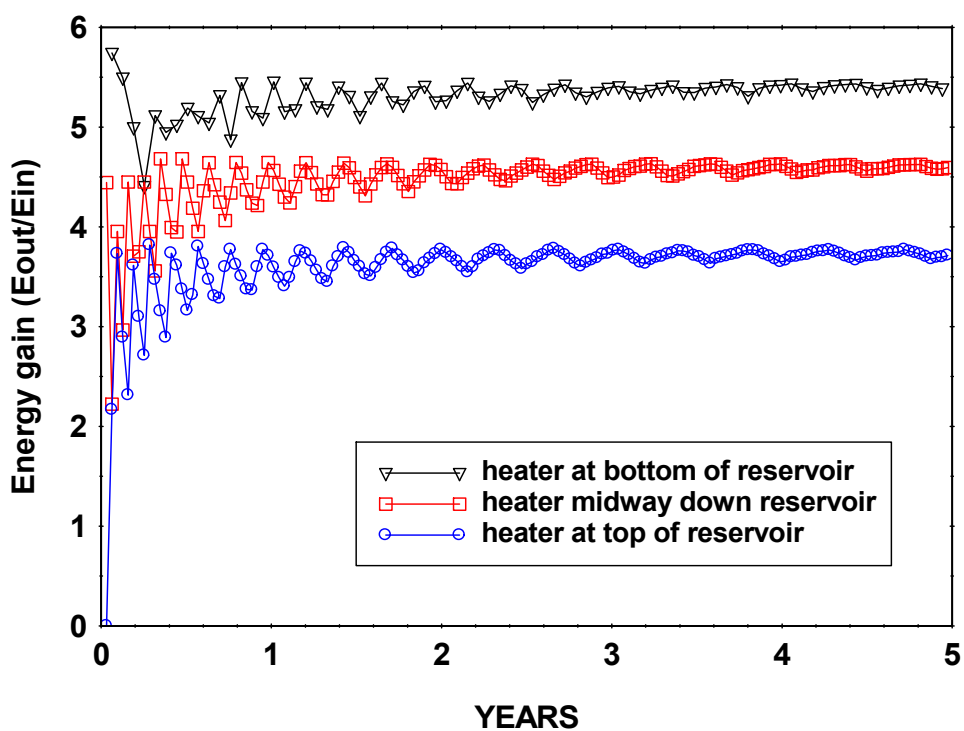
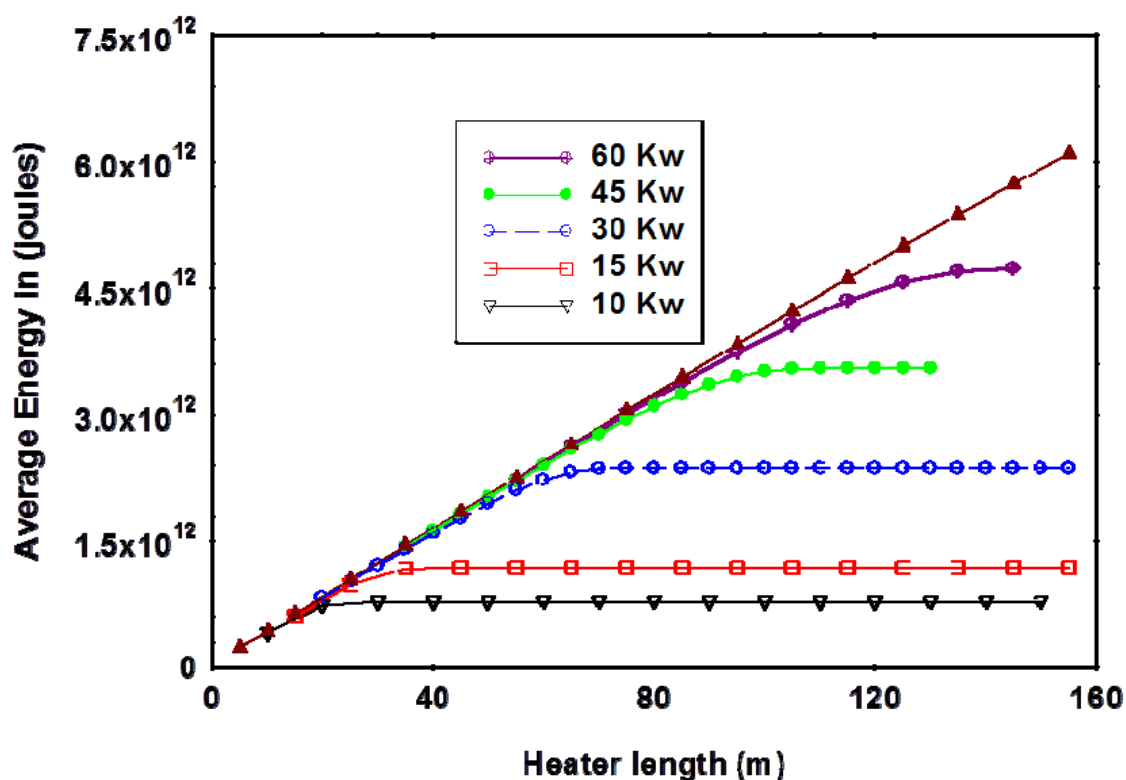

Figure 7 shows that the time averaged input energy will tend to a constant when the different heaters are always ON (thus dissipating maximum power). Initially they are ON and OFF (as controlled by the temperature limiting system), but as their length increases the power density will decrease and they will be ON all the time.

Figure 7. Time averaged energy input over a 5 year period vs. heater length for different heater powers. The heaters are located at the top of the reservoir (radius = 0.1524 m, $T_{max} = 200\text{ }^{\circ}\text{C}$).



This effect is also shown in Figure 8 where the energy gain is plotted as a function of heater length. The figure shows that at a certain length, a maximum point is reached in energy gain, and then this energy gain decreases as the power density in the heaters is reduced when their volume increases.

Figure 8 shows the level corresponding to an energy gain of 3. Only energy gains above this level will yield a positive energy gain for 50–60 Hz electrical heating. This is the case when electrical energy is produced by conventional thermal plants with efficiency of the order of 33–34%.

Figure 8. Energy gain (Energy out/Energy in) over a 5 year period vs. heater length for different heater powers. The heaters are located at the top of the reservoir (radius = 0.1524 m, $T_{max} = 200\text{ }^{\circ}\text{C}$)

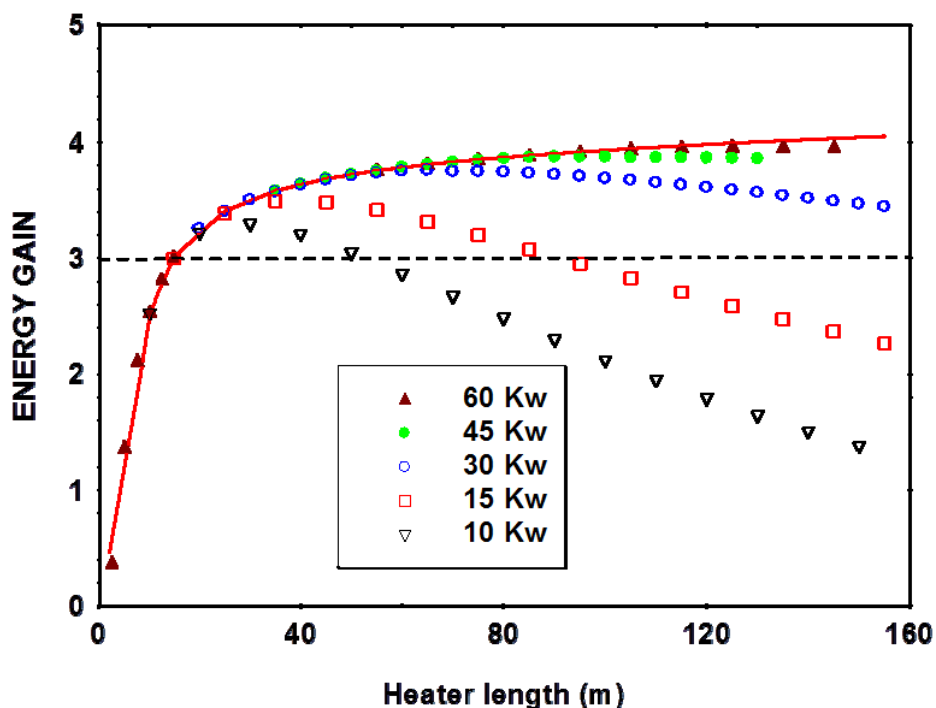

4. Conclusions

We have determined the response of seabed methane hydrate deposits under electrical low frequency heating. The losses associated with the cables from the surface to the heaters have not been considered. For heaters with three phase voltages of the order of 2000 volts, one can easily show that the energy loss along a cable is similar to that in cables used for submersible pumps of an order of 1–2%, for cable lengths of one kilometer.

For heaters located at the top of the MH reservoirs the maximum EROI (energy return on energy invested) is of the order of $(3.7/3) = 1.24$ (see Figure 6). This is the EROI value for the case when only the electrical energy is considered in the calculation.

If one were to consider the energy required for the construction of the heaters, the pipes, and the pipe and the installation process, the total EROI would be even less. Electrical heating using microwaves is out of the question as the efficiency of conversion from 60 Hz to microwaves is of the order of 50%.

Ideally, for maximum net energy balance, the electrical heaters used for the production of methane from methane hydrate deposits should be energized with electrical power generated by hydroelectricity, where the efficiency of generation is of the order of 80–85%.

An interesting heating scheme, using hot water produced in the heater exchanger of a floating electrical power plant located close to the MH reservoir, was presented by T. Yamakawa *et al.* in reference [15]. This is the scheme proposed for the production of gas from the submarine deposits

located in the Eastern Nankai trough off the coast of Japan. It would certainly be interesting to determine the EROI for this process.

The results obtained in this paper indicate that methane hydrate plugs in oil producing pipelines could be conveniently eliminated with the insertion of electrical heaters. Problems with MH plugs can be analyzed and solved along the lines of the present paper using different temperature boundary conditions. For these problems the EROI concept is not pertinent.

References and Notes

1. Makogon Y.F. *Hydrates of Natural Gas*; PennWell Publishing Company: Tulsa, OK, USA, 1981.
2. Sloan E.D. *Clathrate Hydrates of Natural Gases*; Marcel Dekker Inc.: New York, NY, USA, 1998.
3. Carroll, J. *Natural gas Hydrates*, 2nd ed.; Elsevier: Oxford, UK, 2009.
4. Kvenvolden, K.A. Gas hydrates as a potential energy resource: A review of their methane content. In *The Future of Energy Gases*; USGS Professional Paper 1570. USGS: Reston, VA, USA, 1993; pp. 555-561.
5. Demirbas, A. *Biohydrogen: For Future Engine Fuel Demands*; Springer-Verlag: London, UK, 2009.
6. Arata, N., Sukizaka S., Awashima Y., Okada Y., and Ogisako E., Overview of the R&D Program For An Environmental Impact Assessment Of Hydrate Exploitation in Japan. In *Proceedings of OCEANS'08 MTS/IEEE conference*, Quebec, Canada, September 2008, IEEE Press.
7. Callarotti, R.C. , *Electromagnetic heating of oil*, in *SPE Handbook of Petroleum Engineering Vol. 6; Chapter 12*, Lake, L., Ed., Society of Petroleum Engineers: Houston, TX, USA, 2007; Volume 6, pp. 567-609.
8. Callarotti, R.C., Methane Hydrates As An Energy Source, In *Proceedings of the International Annual Conference Interdisciplinary Approaches to Sustainability*, CIEMADEeS Second International Annual Conference, Gurabo, Puerto Rico, 3–5 November 2006, retrieved from http://ciemades.org/gurabo06_eng.html
9. Callarotti, R.C. Energy Efficiency In The Electrical heating Of Methane Hydrate Reservoirs. SPE paper 137585. In *Proceedings of the Canadian Unconventional Resources and International Petroleum Conference, CURIPC 10*, Calgary, Alberta, Canada, 19–21 October 2010; Society of Petroleum Engineers: Houston, TX, USA
10. Chun-Pyo, H. *Computer Modeling of Heat and Fluid Flow in Materials Processing*; Institute of physics printing: Bristol, UK, 2004.
11. Gupta, A. Lachance, J.; Sloan, E.D.; Koh, C.A. Measurements of methane hydrate heat of dissociation using high pressure differential scanning calorimetry. *Chem. Eng. Sci.* **2008**, *63*, 5848-5853.
12. Waite, S.F. Stern, L.A.; Kirby, S.H.; Winters, W.J. ; Mason, D.H. Simultaneous determination of thermal conductivity, thermal diffusivity and specific heat in sI methane hydrate. *Geophys. J. Int.* **2007**, *169*, 767-774.
13. Dale, A.; Lythall, C.; Aucott, J.; Sayer, C. High precision calorimetry to determine the enthalpy of combustion of methane. *Thermochim. Acta* **2002**, *382*, 47-54.
14. Speight, J.G. *Synthetic Fuel Handbook*; McGraw Hill: New York, NY, USA, 2008.

Sustainability **2011**, *3*

15. Yamakawa, T. , Ono S., Iwamoto A., Sugai Y., and Sasaki K.; A Gas Production System From Methane Hydrate Layers By Hot Water Injection And BHP Control With Radial Horizontal Wells. SPE paper 137801. In *Proceedings of the Canadian Unconventional Resources and International Petroleum Conference, CURIPC 10*, Calgary, Alberta, Canada, 19–21 October 2010; Society of Petroleum Engineers: Houston, TX, USA

© 2011 by the authors; licensee MDPI, Basel, Switzerland. This article is an open access article distributed under the terms and conditions of the Creative Commons Attribution license (<http://creativecommons.org/licenses/by/3.0/>).

Part IV: Looking Forward

Article

Predicting the Psychological Response of the American People to Oil Depletion and Declining Energy Return on Investment (EROI)

Jessica G. Lambert* and Gail P. Lambert

Next Generation Energy Initiative, Inc., 32 First Street, Marcellus, NY 13108, USA;

E-Mail: GLambert.NGEI@gmail.com

* Author to whom correspondence should be addressed; E-Mail: JLambert.NGEI@gmail.com;
Tel.: +1-315-278-7954; Fax: +1-315-804-6555.

Received: 29 June 2011; in revised form: 1 August 2011 / Accepted: 5 August 2011 /

Published: 7 November 2011

Abstract: Oil has played a crucial role in the United States' continued but increasingly tenuous economic prosperity. The continued availability of cheap, high energy return on investment (EROI) oil, however, is increasingly in doubt. If cheap oil is increasingly constrained, how might that impact the American psychological sense of personal and national well-being? We employ general systems theory and certain key paradigms from psychology and sociology to predict the possible societal response to global peak oil and the declining EROI of whatever oil is produced. Based on these frameworks, the following three defense mechanisms seem likely to be employed by individuals and groups within society if and when confronted with stresses associated with declining oil availability. These are: denial of one's passive helpless state, desire to establish a scapegoat, and arousal of affiliative needs and increased subgrouping. A group's "survival" is a function of its unified sense of direction and the stability of necessary interdependencies and linkages. We suggest that the ability of the U.S. society, taken as a whole, to adapt to the stresses derived from the declining EROI of oil will increase during periods of moderate stress, and then decline after reaching its maximum ability to cope with stress. The integrity of interdependencies and linkages—power, communication, affect, and goals—must be preserved for continued social unity. Americans will need to acknowledge the reality of biophysical constraints if they are to adapt to the coming energy crisis.

Keywords: energy; EROI; Maximum Power Principle; stress, Psychological Defense Mechanisms

1. Introduction

Over the course of modern human history, societies have experienced many periods of economic prosperity followed by decline. According to Tainter [1], Odum [2], and Cleveland *et al.* [3], these economic fluctuations have tended to result, directly or indirectly, from variations in a society's access to cheap and abundant energy. Events within the past few decades appear to be consistent with these patterns. The last four out of five national recessions, which have been punctuated by financial institution collapse and bankruptcy, have coincided with higher oil prices [4].

The oil industry has historically played and continues to play a crucial role in the U.S. economy, transportation, trade, and in the maintenance of affluence, *i.e.*, "the Western way of life". There has been more than a three-fold increase in energy consumption in the U.S. over the past 50 years [5]. U.S. economic well-being, national prosperity and stability is inextricably linked to the production and consumption of energy, especially oil [6]. There is a great deal of evidence that we may be entering a period where energy and energy services are much less available to the US and other OECD (Organization for Economic Co-operation and Development) countries. For decades we as a global society have spent an increasingly greater proportion of our global energy on discovering and extracting lower quality, less accessible energy resources [7]. Growth of global oil production has stagnated since 2004 [8]. Energy return on investment (EROI), the ratio of energy supplied to society divided by the direct and indirect costs of its production and delivery [9], provides one means of estimating the cost of oil, one which allows us to measure or estimate how much net oil is available to the economy and might be available in the future [10,11]. While this presumably provides us with more accurate and specific information on future availability than price alone, it does not address the potential effect of changes in oil availability on societal processes. It appears clear that the impending energy crisis will create technological issues and political problems. What is far less clear is the impact on societal processes and more generally on the psychological well being of citizens.

There are significant differences of opinion amongst various members of the peak oil community as to how individuals and small groups within society are likely to react to the effects of the declining supplies and EROI of oil. Some scientists predict that severe oil scarcity will constrain food production, exacerbate poverty in marginal sub-cultures, limit production and conveyance of essential goods and services, expand rifts among social groups, strain other limited environmental resources, and destabilize the state's authority and ability to govern [12]. Others believe that very high-energy usage by U.S. society is not required either for prosperity or for American psychological well-being [13]. Nevertheless the most likely scenario is that Americans (and others) will not be happy about any reduction in their lifestyle as measured by traditional economic criteria. Many researchers believe that Western societies will probably experience significant social-psychological disruption and even societal disintegration.

Although, sociological and psychological assessments performed in the wake of previous energy crises provide crucial components to our understanding of reductions in energy flow, so far they fail to

provide paradigms for discussing the possibility of an indefinite energy decrease that may influence the essence of Western social life. No one knows for sure what the psychological or sociological ramifications of declining oil availability will be, but it is important to begin evaluating and preparing for the social aspects of what might be a very different future. We write this paper not to provide a dogmatic catalog of probable psychological consequences of these far reaching technological, political and societal issues, but rather to open a dialogue on the issues.

Many of the examples used, and theories stated, in this article are extreme versions of the normal psychological and sociological phenomena that occur routinely in the day-to-day functions of any group or society. This paper discusses a segment of the wide spectrum of psychological and sociological responses to extreme stresses such as those that may accompany an energy crisis of large and continuing magnitude. We propose that the main psychological response to energy-related limitations and constraints will be the production of stress [a psychological term which, as we will develop, is far more complex than the usual use of the term], a feeling that ensues because demands exceed the resources an “individual” is able to mobilize, producing physical and psychological reactions that result in mental [14]. This mental tension will probably produce, to varying degrees, the psychological and sociological reactions described in this article.

Historically, a society able to procure and intelligently utilize abundant resources typically experiences economic prosperity. The opposite is also usually true; a society entrenched in an environment with scarce resources, as a rule, experiences economic paucity [12]. If energy is as important for civilization and our economy as we believe, and if and as traditional liquid fossil fuel energy supplies decrease in quality and quantity while the human population continues to grow, we are forced to ask: “How will individuals and small groups within a population accustomed to an increasing and seemingly unending supply of cheap and abundant oil react when faced with a future of declining oil availability?”. Curiously, sociologists and social psychologists have barely entered into this discussion. While limited in their education in, and understanding of, the complex technology of the peak oil and related issues, many sociologists nevertheless are competent to examine the possible social ramifications of stress more generally and the related societal processes. What we wish to do here is to apply this general expertise to the stress conditions that are likely to occur from the extensive changes resulting from depleting and ever lower quality oil reserves. A review of political and social responses to scientific pronouncements of declining oil reserves over the past decades reveals a major disconnect between scientific knowledge of depleting oil assets and societal action. Political leaders, traditional economic analysts [15], and mainstream society have largely ignored or downplayed the implications of diminishing oil reserves. The rather baffling question is: “Why have repeated scientific warnings of declining oil reserves and depletion of domestic as well as foreign sources been generally disregarded?”. How are people and society likely to respond to this decline if it continues or accelerates? This is an extremely difficult but potentially important question. We turn to the general psychological literature on the response of humans to stress as a starting place for considering this question. There is substantial literature in the fields of psychology and sociology regarding the responses of people when faced with overwhelming crises resulting from war, pestilence, extended crop failure or resource depletion. We apply this literature to establish an understanding of the probable response of people to stress associated with diminishing oil availability. The objective of this

paper is to examine the possible societal and individual stress that is likely to be perceived by American society resulting from resource depletion associated with the decline of oil.

2. General Systems Theory and Stress

Stress, in the sense the word is used in psychology, occurs when there is a union between a stressor (the cause of the stress) and the “individual” perceiving the stressor; stress cannot exist without exposure to, and perception of, the stressor. Throughout this paper we refer to “stress” with the understanding that all stress exists only because it is perceived. Hobföll’s Conservation of Resources stress model links the production of stress directly to the perceived threat of resource depletion, actual resource depletion, and lack of gain in resources following energy investment [16]. He suggests that people strive to acquire, maintain, and protect resources and that when these resources are threatened, when there is potential or actual loss of these resources, stress is induced. While Hobföll speaks of stress caused by various types of resource depletion and references ‘people’ as his level of analysis, we believe that his thinking is applicable to societal as well as individual stress. We suggest that the American public, as a whole, will experience stress as an outcome of perceived and real resource depletion associated with the decline of oil. These possible psychological and social reactions will not be limited to the individual and small group level but will be exhibited on the societal level.

Boulding’s general systems theory suggests that observations and analyses of behavior and actions of “individuals” (the term Boulding uses to describe the unit of analysis) at lower levels may be used to understand and suggest possible behaviors and actions of “individuals” at higher levels. In other words, societies are composed of small groups, small groups are composed of individuals, individuals are composed of organs, organs are composed of cells, *etc.* [17,18]. While acknowledging differences associated with scale, we believe that an assessment of societal response to oil depletion using research and theory designed for smaller scale analysis may provide insight into patterns of social behavior. According to Boulding, although the definition of the “individual” (unit) may vary greatly, every scientific discipline studies some sort of “individual” and each of these “individuals” exhibit “behavior”, action or change that is related in some way to the environment of which that “individual” is a part [17]. This model, based on the premise of similar typologies among working components at various vertical levels within a society, establishes the theory of scale-free dynamics within social systems. This results in social networks that surpass the specifics of a distinct system and are inherently tied to, and reflective of, the action taken by “individuals” occupying similar roles at higher and lower levels within a network. Boulding further suggests that when the individual is a human being, it is not only the person but also the roles of those persons that create the next level, the social system of which they are a part [17,18]. The connectedness between these levels facilitates analysis of behavior, actions and changes at multiple levels. In other words, observations/analyses of behavior occurring at one level can be employed to provide a better understanding of behavior occurring at adjacent levels. We believe that examining relevant individual psychological and small group sociological research, which explores individual and group reactions to experiences perceived as stressful, provides a starting point to facilitate an analysis of possible small group and societal reactions to depleting oil resources.

3. General Human Response to Stress

Irving Janis in his 1958 book, *Psychological Stress*, developed a paradigm of general human reaction applicable to various severe stressors. Janis' research on general patterns of human response to new stressors concludes that human adjustment and response to threatening or stressful situations varies with the amount of perceived threat. These responses occur as a series of phases independent of the specifics of the stress analyzed. The more immediate an anticipated threat of danger, the greater the motivation to diminish anxiety by minimizing one's perception of potential danger or by denying the gravity of the situation [19]. These expressions of denial tend to be manifested by over-optimistic expectations that:

- (1) Minimize their perception of the probability or magnitude of the potential danger,
- (2) Maximize the person's perception of their ability to cope with the danger, or
- (3) Maximize the person's perception of their chances of receiving adequate help or gratification from the potentially dangerous situation [19].

New stimuli tend to be perceived and interpreted within the context of the known and familiar and viewed as non-threatening until such interpretations are no longer sustainable. When assessing future danger, there is a tendency to extrapolate past trends linearly and draw upon previous experiences to define present circumstances [20]. Fear reactions are not extinguished; they are merely subdued temporarily until the threat is past or clear evidence of danger is brought into the narrowed focus of attention. Once aware of the reality and magnitude of a significant genuine threat, individuals are forced to reconsider their optimistic assumptions, and they tend to feel and display the fear that they had temporarily managed to inhibit [19]. As long as Americans do not perceive the direct and tangible effect of declining EROI of oil, they can and will likely continue to exhibit minimal response.

Here the question of the pathology of denial arises. At what point shall denial be deemed pathological? Experts in a myriad of fields including ecology, engineering, and economics have been ringing oil resource depletion warning bells since the 1970s American Oil Crisis [21]. To many, the 1973 Arab Oil Embargo served as an indicator of the impact of future global peak oil, and members of the scientific community have been cautioning the world ever since [22]. In the face of seemingly unquestionable evidence to the contrary, why have some "individuals" within U.S. society continued to deny the impending energy crisis?

Denial is deemed pathological if there is an unwavering rejection of a highly undesirable fact about a present situation in the face of evidence that is clearly perceived and generally regarded by others as "unquestionable" [19]. The resulting impaired judgment appears to be the handiwork of conscious suppression coupled with unconscious repression colluding to create and maintain a "pseudo-optimistic" attitude [19]. Although it appears, at this writing, that the majority of Americans have never heard of the term "peak oil" and few are knowledgeable about timelines for possible oil depletion, most have some awareness of the previous (1970s) oil crisis and the possibility of repeating that scenario. We ask, "What will happen when reality sets in, when the world's oil production peak is finally conclusively verified and we start the slide back down the energy curve? Will we futilely attempt to hold fast to our comforting delusions"?

4. Defense Mechanisms Associated with Perceived Stress

According to Janis, once the reality of a crisis situation has filtered through, a variety of potential defensive reactions spring to life. Three of these defense mechanisms seem most likely to accompany the perceived stress associated with a possible oil crisis:

- (1) Denial of one's passive, submissive state,
- (2) Use of "scapegoat" mechanisms, and
- (3) Increased affiliative needs and the formation of closely-knit sub-groups.

These defense mechanisms are often accompanied by a temporary gap in memory, with retrospective distortion of pertinent facts surrounding the threatening situation [19]. This process is a manifestation of a conscious turning away from, and an unconscious curtailing of, thought processes involved in comprehending the threatening situation.

4.1. Rejections of the Passive Submissive State

The concepts put forth by Janis are not new in psychology. Anna Freud, Sigmund's daughter, suggested two interrelated, unconscious defense mechanisms related to the rejection of one's passive submissive state: (1) identification with the aggressor, the one in control, the one with the power [23]; and (2) the fantasy that one can inflict the feared damage upon the aggressor, a denial of one's actual passive, helpless state. "Originally described as a defense used by children to cope with overwhelming fears of a powerful parent, this mechanism has also been observed in adults who are under the realistic threat of severe punishment from powerful authority figures..." [19]. In these circumstances, powerless persons react to their passive submissive state by expressing the fantasy that they are the aggressor, in the "all-powerful position," and the authority figure is passively helpless [23]. We utilize general systems theory to indicate that this shift in perception is applicable to various positions and levels of societies: political and military leaders, politicians and societies as a whole can shift from an initial recognition of impotence to a belief that they possess the necessary power to control or at least influence the desired outcome.

According to the laws of physics, power in the physical realm is defined as the ability to perform work [24]. The ability of developed nations to perform work: to manufacture, to industrialize, to exploit, create, and maintain a strong economy, is intrinsically linked to access to and utilization of petroleum-based energy [25]. Without energy one is unable to perform work and is therefore rendered powerless. Henri Bérenger in 1921 summarized this position, "He who owns the oil will own the world, for he will own the sea by means of heavy oils, the air by means of the ultra-refined oils, and the land by means of the petrol and the illuminating oils. And in addition to these he will rule his fellow men in an economic sense, by reason of the fantastic wealth he will derive from oil—the wonderful substance which is more sought after and more precious than gold itself." [26]

The intrinsic link between access to and control of petroleum and military power [27] was clearly demonstrated during World War II. The Allies crippled the German military by targeting fuel supplies that were imperative to German military operations as well as to their industrial sector. Allied forces won the infamous Battle of the Bulge because the Germans simply "ran out of gas" [26]. Germany, with no oil and moderate amounts of coal, had insufficient energy to sustain Hitler's military machine.

The U.S. military also experienced a taste of the impact of insufficient oil on military action when General Patton found his Third Army forces without the necessary fuel to go into battle in Germany [28]. At this time the U.S. was the major global oil supplier, producing approximately 75% of the petroleum used throughout the world [29]. Ownership of this massive piece of the energy pie greatly facilitated the outcome of this war [26]. At the end of World War II, the United States was a world super power and because it owned the oil, it *did* own the world and *did*, in an economic sense, rule over its fellow men. Today, the Middle East has 58% of the world's proven oil reserve [30]. The U.S. no longer commands the oil genie. Although Americans may continue to feel a sense of economic entitlement, this is possibly an indicator of a collective denial of U.S. economic and perhaps even military vulnerability.

The major global energy holders are the Middle Eastern countries, controlling 57.5% of the world's demonstrated oil reserves [30]. Saudi Arabia, alone, possesses the lion's share, approximately 20%, of global oil reserves [31]. This large and essential energy reserve provides Saudi Arabia and other Middle Eastern oil producing countries with the ability to influence production, trade, and the day-to-day activities of Western culture [31]. The U.S. energy/power position is even more untenable, because it uses some 22% of the world's oil consumption while owning only 1.7% [30] of the world's oil reserves [32]. If oil does translate into political and economic power then nations in possession of abundant and easily accessed oil are truly in positions of power. The power that the U.S. once wielded as a result of controlling the lion's share of the world's oil has shifted. Denial of this shift in energy resource power and refusal to accept the accompanying submissive state has required the implementation of a new national definition of power.

Today, the "American way of life" is dependent upon and is unable (with current technology) to exist without accessing energy, mainly oil, from others [33]. To sustain this way of life, the U.S. must now rely upon military strength, diplomatic relations, and a large but deteriorating economic situation to maintain the energy flow from other nations. The U.S. military expenditures in 2009 exceeded \$660 billion (USD), which is 43% of the world's total military budget, an amount greater than the combined expenditures of the other top 15 nations with the highest military expenditures for 2009 [34]. This large military budget provides a strong overseas military presence, one purpose of which is to insure the constant energy flow necessary for the perpetuation of the day-to-day activities and affluence of Western culture.

One measure of power is gross domestic product (GDP), the value of all final goods and services produced within a nation in a given year. U.S. GDP, currently over 14 trillion USD, has been the largest in the world economy since the end of WWII [35]. But here too the production and consumption of the goods and services that comprise the U.S. GDP are fundamentally reliant upon oil supplied from outside the U.S. and increasingly by Middle Eastern countries [36]. The fragile diplomatic relations between the U.S. and Middle Eastern countries, during the post WWII era are fundamentally linked to the maintenance of the world oil trade status quo and U.S. reliance upon a world economic system that requires very large U.S. imports of oil and other basic and also manufactured resources. The Arab Oil Embargo [37], Desert Storm [38], the "9/11" fall of the Twin Towers [36], the Iraq "war" [39] and the War on Terrorism [36] are all direct or indirect manifestations of the U.S. need for foreign oil and the complex responses of both the U.S. and those who supply it [40]. Thus as the U.S. has become increasingly dependent upon imported resources, resource-rich "developing nations" increasingly are

able to impact the destiny of U.S. wealth, prosperity and, perhaps, national security. U.S. economic and military reliance on energy from potentially unfriendly foreign sources [41,42] in conjunction with the jarring reality of U.S. susceptibility to foreign attacks, heightened by the 9/11 terrorist attack [43], has made Americans aware of their vulnerability, to an extent that the U.S. populace has hitherto not been exposed. In cases such as these, a sense of impotence can shift to a belief, or fantasy, that the necessary power to control or at least influence the desired outcome may be obtainable if sufficient resources are diverted to this endeavor [23]. The demand by the U.S. to envision itself as in an “all-powerful position” has resulted in an exaggerated global military presence designed to influence oil rich nations’ willingness to abide by established Western trade practices favoring U.S. economic prosperity.

In conclusion, we argue that the U.S. military presence in the Middle East was facilitated by a national sense of loss of international power, economic control, and less effective attempt to control the flow of oil. U.S. foreign oil dependence has grown while U.S. production has declined. Thus, the U.S. is, in a sense, replacing its previous world oil prominence with extensive global military prominence.

4.2. Scapegoat Mechanism

Janis’ second defense mechanism, scapegoating, appears initially as a latent attitude rather than overt action. According to Janis, scapegoating is the wish, fantasy, or desire that “if somebody has to suffer, let it be him rather than me” [19]. To effectively accomplish this, intolerance, bias, prejudice, and stereotypes are established enabling those impacted to deflect their frustrations to other people through the imposition of discriminatory injustices and, if necessary, death and destruction to be directed toward the “target” without guilt. These de-humanizing processes not only facilitate the establishment of a scapegoat, they justify actions which are then taken against individuals and groups defined as flawed and inadequate [44]. This egocentric concern for one’s own well being at the expense of others yields a narcissistic disconnect from traditional moral grounding and can be accompanied by guilt and depression, and even fears of retribution, that “next time it will be my turn.” Once scapegoating has occurred, these emotions and concerns for “payback” and/or revenge may result in excessive docility, apathy, and other depressive symptoms. Use of de-humanizing scapegoating to justify actions taken to bolster one’s own situation is particularly likely among persons exposed to extremely stressful situations where escape is believed to be highly improbable or impossible [45].

Traditionally, conflicts between rich and poor, once played out in the streets of industrial cities, had been subdued by an increase in the wealth of the nation as a whole (*i.e.*, “a rising tide lifts all boats”). Throughout the past five decades, however, the Ginni coefficient (a measure of the equitability of the distribution of wealth) steadily increased, indicating greater inequality between rich and poor. During this period American workers were relatively quiescent about this because their paychecks, even when corrected for inflation, tended to increase. That general trend has now ceased; take-home income for U.S. working families actually decreased by eight percent during the 2000 to 2009 period [46]. This cessation of income growth is almost certainly associated directly or indirectly with a reduction in the growth rate of oil production and the net energy from it. As the growth in oil production diminishes (*i.e.*, the sequence to “peak oil”) and the EROI of oil and other major fuels continues to decline, it seems fairly likely that the economic pie will continue to contract.

As the EROI of global oil declines, it is likely that larger portions of the “working class” population will become impoverished, fewer manufacturing jobs will be available, and the need for manual labor supporting these manufacturing jobs will continue to decline [21]. The global manufacturing landscape has already experienced these trends. Current movement towards mechanization and automation [47] has resulted from the managerial goal of low labor cost and high labor productivity. One effect has been the displacement of workers from relatively high-paying industrial jobs [48]. Industry has turned to international competition and modern petroleum-based technology to meet its goals of enhanced productivity, with fewer workers required to accomplish the same task, and lower production costs [49]. Increased productivity has traditionally allowed both labor and management to make a greater profit, and this had played a significant role in the great wealth accrued by America throughout the middle of the last century. The ongoing trend towards computerization and robotics throughout the U.S. economy (*i.e.*, everything from retail store self-scanning checkout stations to automated manufacturing plants) and movement from domestic production to international labor markets has resulted in higher labor productivity. The downside is a decreased need for labor within the U.S. economy, especially for the industrial manufacturing jobs that once provided enormous collective wealth for the American working class [50]. As labor opportunities dwindle, there is a tendency to seek scapegoats on whom to blame decreased employment prospects. Recent government campaigns to limit or halt immigration during periods of economic recession and high domestic unemployment [12,51] and periodic campaigns to buy products “made in America” exemplify societal responses to fears of perceived (and real) employment scarcity. Increased apathy and depression manifest during extended periods of increased unemployment and decreased probability of re-employment [52].

The desire to identify and blame the culprits behind the myriad of social and economic problems (related to the issue of decreasing cheap energy) is not limited to issues surrounding imported products and immigration. The American populace and mass media are accustomed to seeking scapegoats from among the leaders of various sectors of society for what they perceive as the inept handling of the multitude of social issues and economic crises facing the country. Failing industry, banking and investment collapse, and government policies and decisions have been subject to government committee investigation, media scrutiny, and become common topics of conversation across the United States [53]. Without regard for the political party currently in power or the decisions currently being made, Americans choose to blame those on Wall Street, the various CEOs and CFOs of industry, the White House, and the politicians on Capital Hill for the current “state of distress” rather than recognizing the increasing reality of the end of growth of oil and cheap energy [54].

4.3. Affiliative Needs and Sub-Grouping

Janis reports a third response to perceived stress: an arousal of affiliative needs (the desire to associate with others that hold or espouse similar ideologies and commonly perceived needs). This group-level defense mechanism is likely to occur during highly stressful moments, especially when the danger of being injured or killed is imminent [19]. This is usually expressed as an unusually high need for companionship and affection among individuals within the group [19] and coincides with a willingness to drop normal psychological barriers. When a large group of people are faced with impending demise or physical damage, these strong affiliative needs tend to result in the formation of

sub-groups of individuals of like minds within the larger group [20]. Factions of strangers may experience a sudden sense of unity when exposed to perceived danger.

For example, the American citizenry's reaction to the terrorist attack on the United States on 11 September 2001 and its aftermath exemplifies this psychological and sociological response. America's momentary abandonment of conventional social barriers (e.g., strangers on the streets of New York City embracing and consoling one another immediately following the Twin Tower collapse) and subsequent societal communion reflect strong affiliative needs during a time of perceived stress. Acts of increased patriotism in the form of increased flag purchases, flag flying, and bumper stickers espousing nationalistic phrases clearly support the presence of this phenomenon. A simple comparison of U.S. flag sales for Wal-Mart Stores, Inc. on 11 September 2000 (6400 flags) and 12 September 2000 (10,000 flags) *versus* those purchased on the day of the attack, 11 September 2001, (116,000 flags) and the following day, 12 September 2001, (250,000 flags) [55] demonstrates an immense and immediate pro-American communal response to the attack and perceived threat of attack [56]. This intense single-minded nationalism eventually shifted to the formation of sub-groups espousing varying levels of anti-Terrorist/pro-American affection as variations in perceptions became apparent [57].

Currently the U.S. retains access to an abundant although expensive supply of oil. Declining oil reserves and production, in both the U.S. and the world, however, will likely lead to a disruption in oil supply and eventual damage to the U.S. social, political, and economic framework [12]. The current popular call for "fiscal responsibility" is an example of societal reactions to this new perceived scarcity. Disruption of the societal framework by interruptions in oil supply, at least in the short-term, is apt to rekindle the intense affiliative needs and subsequent sub-grouping behaviors observed in the aftermath of the 9/11 terrorist attack. It is possible that these affiliative needs and resulting re-kindled like-minded groups espousing a "we *versus* they" mentality may result in the U.S. exercising diplomatic and military measures to secure resources (oil) necessary to ensure the continued "American-Western way of life".

4.4. Net-Effect of Employment of Defense Mechanism

The net effect caused by the employment of these modes of defense is the formation of an illusion of personal invulnerability. Survival of one or more dangerous situations tends to reinforce these feelings [19]. The 1973 Arab Oil Embargo first exposed the precariousness of the US-OPEC oil trade. The resulting severe fuel shortage produced numerous energy saving policies (e.g., reduced speed limits) and technological changes (e.g., installation of residential solar hot water panels and production of smaller automobiles). After oil availability and prices returned to previous levels, energy saving efforts and concerns about oil availability waned. Apprehensions were assuaged, American life returned to normal, and speed limits and the size and power of most American automobiles gradually climbed.

This reaction is not unlike that of WWII British air-raid victims studied by Janis. Air-raid victims reported that although they immediately sought shelter upon hearing the first air-raid sirens, they did not continue to do so for subsequent sirens. Even though initially they were quite certain that they were going to be killed, when the all-clear signal went off without incident, they felt secure that they were in no danger. Having survived a previous strike(s), they continued their routine activity during subsequent

air-raid attacks; they no longer felt threatened and did not seek shelter even though some were killed [45]. This is an extreme example of denial of vulnerability and desensitization, a psychological process where repeated exposure to a fearful circumstance significantly alters the subsequent responses.

Although the threat produced by the 1973 Arab Oil Embargo was not life threatening, as was the London air strikes, it was the first oil shortage, controlled by foreign nations, experienced by U.S. citizens. The U.S. experienced domestic peak oil production in the lower 48 states in the early 1970s [58]. This coincided with the rise of OPEC, the usurpation of Aramco and other subsidiaries of multinational oil companies by Saudi Arabia and other OPEC states, and the quadrupling of the price of oil in 1973–1974 [59]. This brush with peak oil and oil shortage provides a window into the psychological and sociological responses of the American people to the relatively high intensity stresses of declining oil availability. The subsequent reduction in oil availability resulted in short fuel supplies, higher fuel prices, long queues, and consumer supply limits [60]. What followed were severe recessions, inflation [61], and a loss of jobs [62], in other words a very large stress to our society. The acuity of the '73 oil crisis led to an almost ubiquitous realization by the American people of U.S. dependence on oil for the maintenance and support of its economic machine.

While some within the U.S. sought a more aggressive solution to the problem of obtaining oil from foreign sources [63,64], the prevailing opinion within the U.S. populace was that government should take a more passive role in international affairs, be cognizant of its limitations, and focus on domestic problems [65]. Denial of one's passive submissive state does not seem to have played a significant role in the U.S. response to the oil crisis of '73. While the '73 oil crisis did represent a strong stress event in U.S. history, it is important to distinguish this event from our current circumstances as U.S. oil production at that time accounted for almost 80 percent of domestic oil needs [66]. Additionally, the OPEC embargo accounted for only a 4 percent reduction in U.S. oil consumption [66]. Unlike our current energy situation, the U.S. was perceived as a powerful energy producer and was largely immune to the whims of foreign states.

This decrease in oil availability was generally met with strong opposition. According to Belk *et al.*, most American consumers failed to see themselves and the general public as a major cause of the energy crisis [67]. As President Carter indicated, many Americans “deeply resented that the greatest nation on earth was being jerked around by a few desert states”. [64] The U.S. populace sought scapegoats in OPEC countries, the governments of large oil-importing nations, oil companies, and portions of the public that were perceived as wasting finite energy resources [67]. The choice of scapegoat depended upon an individual's perception of “personal responsibility” for the energy crisis. Belk *et al.* found that those individuals that ascribed the collective problem of energy shortages to personal causes were more likely to place the locus of blame on the general public and typically preferred conservation solutions. Conversely, individuals that attributed the collective problem of energy shortages to non-personal causes were more likely to blame oil companies and generally favored government actions against these firms [67]. These stark differences in causal attribution further divided the public along ideological lines and increased sub-grouping phenomena [68].

As the decade progressed, the U.S. populace continued to express concerns over the U.S. energy situation. Throughout the 1970s U.S. majorities indicated that, as a nation, the U.S. was investing “too little” in the development of the country's energy resources [69]. The Iranian Revolution, the subsequent 1979 energy crisis, and the events that followed radically influenced U.S. foreign policy.

Strikes, demonstrations, and protests curtailed Iranian oil production and export leading to reduced oil availability and higher gas prices [70]. In addition to issues experienced during the previous energy crisis, the U.S. populace was forced to face its impotence in thwarting the September 1979 election of Fidel Castro as the leader of the Non-Aligned Movement, the November 1979 Iranian hostage crisis, and the December 1979 Soviet invasion of Afghanistan. The American public's skepticism of détente and the intensions of its southerly neighbor were strengthened after intelligence uncovered the existence of a Soviet combat brigade in Cuba [65]. The following month, Castro assumed his role as leader of the Non-Aligned Movement, a position that afforded Cuba, a perceived enemy of the U.S., with influence over OPEC and other critical oil producing nations [71]. To add insult to injury, Castro delivered a statement on April 24, 1980 that permitted the unrestricted exodus of Cuban nationals. In the months that followed almost 125,000 Cubans arrived in southern Florida [72], many of whom were perceived as "social undesirables". Cuba's benefactor, the then USSR, further threatened U.S. foreign oil interests. A Harris poll concluded that a 78 percent majority thought the Soviet invasion of Afghanistan was a strategy to acquire "more influence over the oil-producing countries of the Middle East." [73] As Yankelovich and Kaagan stated, the American people "felt bullied by OPEC, humiliated by the Ayatollah Khomeini, tricked by Castro, out-traded by Japan and out-gunned by the Russians" [65].

The stress from these energy related circumstances increased affiliative needs and unified the American people toward a common purpose. A poll conducted by Yankelovich, Shelly, and White, found an 80 percent majority believed that the Iranian situation had helped to unite the nation [65]. OPEC, the Ayatollah Khomeini, Castro, and the USSR presented the U.S. populace with ready scapegoats on whom blame for the '79 energy crisis could be attributed. The disquieting realities of late 1979 and early 1980 left the American people frustrated, angry, and anxious over America's novel but pervasively submissive role as an international leader. Faced with the perception of a strategically weaker America, loss of prosperity, and a plethora of failed, impeded, or ineffective foreign policy initiatives, the U.S. populace experienced a decided change that historian commonly identify as a watershed event [65]. President Carter's remarks are a testament to America's perceived sense of emergency, "Let our position be absolutely clear: An attempt by any outside force to gain control of the Persian Gulf region will be regarded as an assault on the vital interests of the United States of America, and such an assault will be repelled by any means necessary, including military force" [74]. Carter's inability to act decisively to effect these sentiments in the eyes of the American people ultimately led to the election and ascension of the Reagan administration; a decidedly different leader charged with redefining America's posture of assertiveness [65]. The American people had grown tired of foreign bullies and wished to reject their passive submissive state by adopting a tougher stance in the international arena.

U.S. government dealings with "troublesome" OPEC nations, during the decades that followed, have been persistently bellicose, determined to avert the loss of control experienced in the wake of the 1979 energy crisis [75,76]. Conversely, the American people were far quicker to forget the tumult of the late 1970s and early 1980s [69]. When the embargo ended and oil prices returned to previous levels, life returned to "normal"; the instability and volatility of the oil trade was largely ignored or denied by the American populace. The economic rebound of the late 1980s and 90s left the people of the U.S. with a false sense of invulnerability and in a state of denial regarding the severity of the

energy crisis situation and only a vague, lingering, perception that eventually long-term changes would be required to facilitate continuous acquisition of foreign oil [77].

5. Impact of Intensity and Duration of Exposure to Stressors

According to Torrance, for groups to survive, they must have, at a minimum, a unified sense of direction or path that, if followed, will assure survival and stable patterns of interdependencies and “linkages”. Torrance suggests that clarity in both of these areas is essential to group survival [78]. The connections and relationships, or linkages that he refers to are the distribution of power within the group, the establishment and maintenance of communication networks, the emotional bonds among members, and the communal goals of the group; these act as the “glue” that bonds group members to one another. Torrance further proposes that a group’s success at maintaining this “glue” is mediated by the variables of duration and intensity of stress. According to Torrance, groups exposed to unabated stress will eventually experience fatigue, the breakdown of essential linkages and finally collapse. He notes that groups may vary dramatically in the length of time required to reach collapse and that the intensity of stress experienced influences this time frame. Before the breaking-point is reached, a variety of positive and negative effects may occur; prior to their demise, groups under stress may initially flourish. The ability to adapt to stressors and flourish is facilitated or thwarted by the effectiveness or ineffectiveness of the previously defined linkages. Torrance’s research suggests that bonds among group members will initially increase with increased perceived stress. Increased bonding will occur until an apex is reached where, although perceived stress may continue to increase, a decline in the strength of these bonds will begin to occur causing disorganization and eventual disintegration of the group. Seyle’s 1975 differentiation of two types of stress: eustress and distress [79] describes similar reactions to that described by Torrance. When response to a stressor enhances the functioning of the individual, it is considered a positive coping response: eustress. This positive response to stressors continues until some theoretical apex is reached. At this point, according to Torrance, although the intensity of stress may continue to rise, a decline in the strength of integrating bonds is likely to occur, causing disorganization and eventual disintegration [80]. Seyle defines this as distress; when stressors persist, unresolved *via* coping mechanisms and adaptation, distress results. One’s experiences, expectations, and resources available for coping with the stressor, as well as the duration of exposure to the stressor, influence the outcome [79].

Figure 1 is our visual conceptualization of Torrance’s ideas on the impact of duration and intensity of perceived stress on group integration. The x-axis represents the duration of a group’s exposure to stress. The y-axis denotes the intensity or degree of stress to which a group is exposed. A society exposed to moderate degrees of stress for a moderate amount of time has the capacity to exist and perhaps thrive under stressful conditions (area C). Area B of this graph illustrates that persistent, unabated stress negatively impacts a group’s ability to perform the necessary integrating maintenance functions that assure survival and stable patterns of interdependencies and linkages. Area A illustrates the impact on a group exposed to sufficiently extreme stressors; the group’s ability to perform integrating maintenance functions will suffer. In other words, groups not only experience a breakdown in their integrative functions when exposed to sufficiently intense stress (area A), they also experience a breakdown in these functions if consistently exposed to varying degrees of unabated stress [80],

without regard for the intensity of that stress (area B). The graph suggests that in combination these two facets of perceived stress: intensity of the stressor and duration of exposure to a perceived stress, result in group breakdown and eventual collapse. It suggests that not only can a group's maximum coping capacity be exceeded but also when this is exceeded, the integrative activities that bond segments of the group together no longer adequately function and a breakdown of that group results. Examples of societal breakdown or collapse resulting from exposure to extreme stress over a short period or modest exposure over a prolonged period are rare. This dearth of historical examples may be due to the complex inter-group dynamics between large social states. Societies exposed to modest degrees of stress for long periods may dissolve completely (e.g., the decline of Easter Island [81]) or may be subsumed by another social state (e.g., the fall of Rome to the Germanic Tribes [82]). Societal breakdown resulting from acute traumatic stress usually follows war or natural disasters and may be accompanied by a period of societal decline (e.g., the fall of Athens to Sparta [83]). It is important to note that all societal collapses are complex, multifaceted, and result from a variety of causal factors.

Figure 1. The interaction of two independent variables: intensity of a stressor and the duration of perceived stress- the impact on group integration.

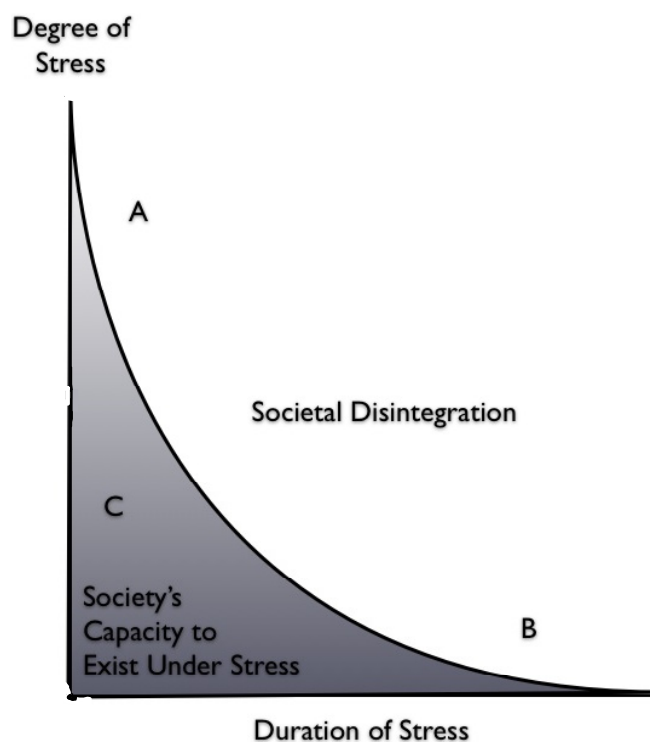

6. Torrance's Model Applied to Future Decline of Oil

Applying general systems theory, we extrapolate societal response to the perceived stress of declining oil availability from general individual and group level responses to stress. We suggest that when groups are conceptualized or envisioned as the collective 'individuals' within a society, Torrance's model of group reaction to intensity and duration of stress can be used to examine societal reactions to stressors that vary in intensity and to which exposure is continuous and unabated. We suggest that Torrance's model can be used to understand the stress introduced to western society

by declining oil. Because oil is a critical non-renewable natural resource, inherently limited and finite, the eventual yet inevitable decline of oil is likely to introduce societal stressors. It will not act as the sole stressor and it may not cause social disintegration or collapse. Rather, it is intrinsically linked with economic, political, and social factors (the underpinnings of an industrial society) that could, if the U.S. persists in a business as usual mentality, unite to produce the breakdown of society [12]. There will undoubtedly be vast differences in the length of time required for various societies, under the stressors associated with the declining EROI of oil, to reach a “breaking-point” or enter a decline in organization and integration. However, if and as this breaking-point is reached, negative effects including confusion, inefficiency, recklessness, apathy, fatigue, hostility, and changes in leadership may be exhibited [80]. We already see some signs of what we perceive as response to declining EROI as the increasing difficulty of governing in the United States at all levels and increasing political hostility of the different political parties.

As we apply Torrance’s paradigm to describe possible responses to stressors resulting from declining oil, we recognize that the ability to adapt may be either facilitated or thwarted by the strength of a society’s interdependencies and “linkages”; the glue binding that society together [80]. The distribution of power, communication networks, emotional bonds, and communal goals within a society normally act as the “glue” bonding members with one another. They unite to form a network of connections that result in a society’s perceived sense of unity and that society’s ability to effectively perform integrating maintenance functions [80]. According to Torrance, as stressors increase, the ability to perform increases until there is a maximum linkage efficiency and effectiveness is reached. If exposure to stressors continues unabated, the linkages binding groups together weaken and the forces “tearing apart” the group exceed the forces maintaining it. We suggest that Torrance’s model of the impact of stressors on social interaction, when envisaged as a plotline, resembles an inverted U-shaped curve. Figure 2 conceptualizes the effect of varying exposure to stressors on interdependencies and linkages that bond various portions of society to one another.

For the purpose of this study we will call this inverted U-shape the ‘Bonding Force Curve’. The Bonding Force Curve applies Torrance’s paradigm, describing societal reactions to perceived stress, to an inverted U-shaped curve model of the dynamic relationship between societal bonding forces and perceived stress. The curve’s inflection point represents the level of bonding at which a group’s performance of integrating maintenance functions becomes de-coupled by increased stress resulting in a decline in a group’s bonding forces.

A variety of authors have found similar empirical inverted U-shaped curve phenomenon related to stress and performance (e.g., Wade’s 1987 analysis of the relationship between resource scarcity and cooperation [84]). Even if the conceptualization of the inverted U-shaped curve is highly simplistic and unable to fully account for the complex relations between humans and their environment [85,86], the proposed model should be considered useful in a global context. Given this theory, we suggest that societies would derive some cohesive benefits from stressors inherent to the declining EROI of oil. These benefits may occur as a heightened sense of societal bonding derived from effective communication, constructive use of power, optimistic affect, and shared collective goals. These benefits will likely continue until society reaches the maximum theoretical advantage derived from increased perceived stress. Once this apex is exceeded, the fabric of society will begin to unravel.

Unfortunately, it is impossible for us to predict or define where the U.S. currently rests on the curve; only in retrospect will we be able to apply a timeline to this trend.

Figure 2. According to Torrance, as stress increases bonding forces increase until a theoretical apex is reached. A decline in the strength of integrating bonds then occurs even though the intensity of stress continues to rise.

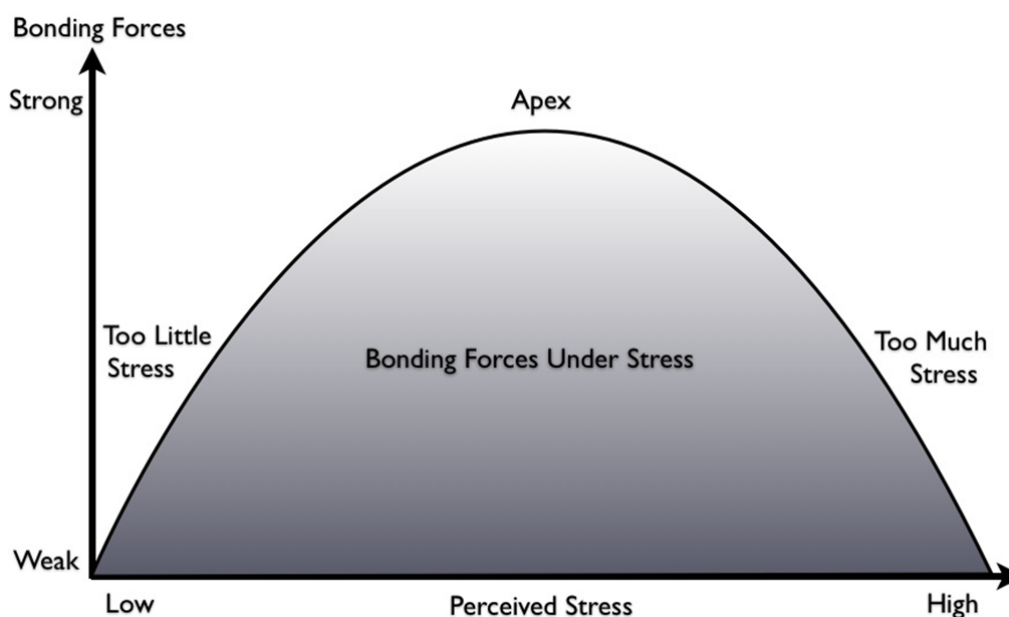

6.1. Communication

Communication, potentially the most readily apparent linkage among group members, is likely to be compromised under high degrees of perceived social stress. According to Torrance, the following conditions appear to be the most prominent in weakening communication linkages necessary for survival within the group [80]:

- (1) Failure of a group member to inform others of what he/she is doing [87],
- (2) Failure to pool information which would provide a basis for diagnosing the seriousness of the danger and reducing resistance to acceptance of its seriousness [88],
- (3) Confining communication to dyads or cliques rather than to the entire group [88],
- (4) Failure to use group judgments in making decisions, and the use of leadership techniques which interfere with this type of communication [89],
- (5) Power differences which interfere with communication of information needed in decision-making [90], and
- (6) Unwillingness to disagree in the decision-making process [91].

Torrance suggests that vertical communication, under stress that is perceived as moderate, becomes more frequent with increasing intensity and/or duration of stress. Once the degree of perceived stress exceeds the group's ability to effectively handle that stress, not only will vertical communications become less frequent, they will become muddled, often reaching only a select few within the group [78].

Famous examples of the impact of truncated vertical communication include President Nixon's infamous Watergate team [92] and President Kennedy's Bay of Pigs Crisis [93].

Applying general systems theory to Torrance's research, which means assuming that the societal level will be the same as the group level, we suggest that leaders of nations experiencing crisis situations are likely to direct fewer communications to the lower status group: the general populace. Those in positions of leadership will instead probably engage in lateral communication within a trusted leadership group while simultaneously reducing vertical communications directed toward mainstream society. The result will be that mainstream society will receive limited and delayed information concerning details of the crisis situation. According to Torrance, the opposite is also true at the group level; when lower group members perceive a large power distance between themselves and their leader, those lower group members may not feel accountable or obligated to communicate pertinent decision-making information with those in leadership positions [78]. To elucidate the severity of consequences to truncated communication within groups, Torrance recounts a story of a lieutenant colonel who was observed, by four crew members, to be sitting on his unattached dinghy during an over-water bail-out. The lieutenant colonel perished as none of these crewmembers felt an obligation to communicate his situation to him [78]. The combined effect of these diminished communication processes at both the group and societal levels is miscommunication, poor judgment, and incorrect decisions, sometimes with large consequences.

The establishment of effective communication among intergovernmental groups has, historically, been a common problem in government. Historically, this issue has been exacerbated by the propagation of competing objectives and personal agendas [94]. Recent United States Environmental Protection Agency (EPA) and Pentagon failures to communicate on superfund sites [95] provide an example. A second example of competing agendas and poor communication is the 2010 funding of a 600-megawatt wind energy production venture between U.S. and Chinese energy groups (U.S. Renewable Energy Group, Cielo Wind Power LP, and Shenyang Power Group) in western Texas [96]. Designed to bring renewable energy as well as installation and managerial jobs to the area, this project was stalled by negative press and congressional concerns regarding the manufacturing source (China) of component parts for the \$450 million (USD) grant [96]. Many of these communication and agenda issues have been addressed through the formation of Federal government oversight taskforces and workgroups intended to target specific policy and social issues perceived as having overlapping or parallel agency efforts. Still, many groups seeking to maximize their own ability to receive "adequate gratification" from and cope with the impending oil crisis continue to exploit existing divisions amongst Federal, State, and regional agency efforts. Unless these communication and coordination issues are purposefully addressed and a common thread of understanding is reached, communication among groups will continue to be threatened by intra-group and inter-group stress.

6.2. Leadership and Power

According to Torrance, during times of perceived crisis, vertical communication tends to decrease and leadership groups typically do not seek decision-making input from lower-status individuals within the group [90]. There is constriction of control and limited downward informational communication to those in lower levels of the social hierarchy, as this is deemed non-essential and

perhaps dangerous [97,98]. Reduced vertical communication results in perceived social isolation from the leader, loss of confidence, and an aversion to further expansion and structuring of leadership. A breakdown in shared understanding between leaders and members of a group, results in greater horizontal informational communication within the social network/group [90]. We suggest that deterioration of hierarchical communication between the leaderships and the “rest of society” will compound any existing stress associated with the declining EROI of oil.

According to Katz, excessive stress may result in conflict within the current leadership group [99]. This is especially true if blame is attributed to members of the leadership [100] and typically corresponds with changes in authority and the leadership process [101]. D.W. Conrath’s codicil to Torrance’s research further elaborates upon changes in the leadership process; the expansion and structuring of leadership is directly linked to conditions of high perceived stress within the leadership sub-group [102]. The range of judgments considered by leaders during the decision making process is a function of group members’ willingness to disagree. The correctness of a decision is positively related to the range of judgments considered [91]. Under conditions of extremely structured and consolidated power, low status persons are more reluctant to express their thoughts and opinions for fear of being found in opposition to high status individuals. Inability to communicate true opinions frequently leads to miscalculations in policy decisions and often makes the difference between continued societal unity and societal disintegration [103].

The Third Reich and German anti-Semitic sentiment are eloquently instructive on this point. The anarchy, chaos, and resource scarcity of the post-WWI era lead to changes in the German authority (from Kaiser Wilhelm II eventually to Hitler [104]) and leadership process (Monarchy to Democracy to Fascism [104]). The extreme structure and consolidated power of the Nazi regime following the severe stress of the post-WWI era, coalesced to produce a populous that willingly turned a blind eye to atrocities performed on people they previously called their neighbors. This example, while extreme, demonstrates the complete passivity of people under high degrees of stress when faced with the fear of being found in opposition to authority figures.

Expansion and increased structuring of leadership (*i.e.*, the systematic hierarchical and horizontal organization of leadership to establish, guide, and direct uniform compliance with group policy) during periods of perceived stress, is evidenced in almost every historically prominent government “power grab”, e.g., Julius Caesar [105], Napoleon [106], and Hitler [107]. Structuring of the government, in these cases, was preceded by widespread societal fears of perceived crisis. Individually, group members typically do not desire expanded leadership and/or additional structuring of leadership [78]. A group’s collective unconscious desire for direction and individual lethargy when faced with the gravity of a crisis situation, colludes to produce a perfect scenario for a political “power grab” and leadership structuring. Under these conditions, democratic processes tend to fail, liberties are eroded, and power is centralized under a central power figure or group. History has a way of repeating itself. Unless constructive changes to current energy policy are formalized and implemented, the United States may experience continued restructuring of leadership and progressive centralization of political power.

6.3. Affect and Goals

Positive group affect (the emotional milieu within a group) and group activity focused on the formation and attainment of group goals increase during moderately stressful conditions and are followed by a rapid decline upon reaching an apex of stress. This pattern occurs in situations of high intensity stress and/or when stressors continue unabated over a prolonged period of time [80]. A group's capacity to survive is dependent upon its skills in organizing its efforts. As a result, disorganized groups show signs of disintegration more readily than organized groups. The ability of a group to coalesce and maintain clarity of purpose is dependent upon its capacity to perform quick, adequate analyses of novel situations, provide clear and concise uniform communication among all group members and maintain the group goal of survival [78]. Random trial-and-error behavior, resulting from a lack of clarity of purpose and insufficient information, is detrimental to the attainment of group goals [108].

The U.S. involvement in Vietnam provides an example of altered group affect and splintered goals during a period of societal exposure to intense, unabated stress. After a very brief period of unified goals and optimism, the U.S. populace plunged into emotional turmoil and diametrically-opposing objectives [109]. This was a situation marked by intense as well as unabated stress as U.S. [110] military troops were exposed to guerrilla warfare on a scale and dimension never previously experienced. As the atrocities of jungle mayhem, news of the day's carnage, and seemingly astronomical American casualties blared across TV screens, the American populace splintered into factions; those opposing the war demonstrated in Washington and rioted on college campuses; those supporting the war effort picketed and campaigned for order at home [109]. The ability of the U.S. to quickly and adequately analyze its military situation was compromised, factions of society were set in opposition to one another, and the emotional tenor of the country as a whole was one of distress, all of which are recognizable signs of social disintegration.

Similarly, poorly organized effort and lack of clarity of purpose are currently evident in the unplanned development of renewable energy. There is an abundance of government and privately funded research in a sundry of "green" energy arenas with little coordination of efforts or evaluation of their net energy contribution. Experimentation within the transportation industry alone includes everything from ethanol to bio-diesel to hydrogen fuel cells, each of which is highly subsidized, highly subject to hype and rarely analyzed by objective science [111]. Industrial energy research areas include everything from effectively harnessing wind, to capturing solar energy using photovoltaic cells, and from diverting river and tidal currents, to growing algae, corn, and willow biomass. Each area initially promises to "solve" the potential U.S. energy crisis resulting from decline in oil reserves, yet each falls short of the necessary EROI to be considered an alternative comparable to oil [112]. If a nearly comparable solution is not found, disillusionment will likely follow. The uncertainty, engendered by unclear and contradictory communications and goals, will likely result in a breakdown of each individual member's ability to accurately decipher and predict their current and future circumstances [78]. This may result in unstable group affect (depression, apathy and ultimately surrender into hopelessness) as we face the real possibility that there may not be an effective and efficient alternative to the energy on which we so completely depend [113].

7. Integration vs. Disintegration

Hamblin found, “Present in every crisis situation is a solution that requires the cooperation of all or most of the members of the groups involved” [113]. During a crisis situation with no apparent solution, integration does not increase, rather it decreases. As each progressive solution fails, frustration mounts, and individual attempts at survival occur. Groups disintegrate when faced with a threatening situation and the solution involves individual competition. This pattern of evoked responses appears to be based in a simple rational model: if the likely solution to a crisis requires cooperative action, group integration increases. Group disintegration results when the crisis situation appears to either have no solution or the optimum solution requires individual action. According to Hamblin, groups remain together only if there are valid and functional reasons [113]. Society will remain intact only while there is a unified purpose that benefits the society as a whole. If the U.S. continues to dissipate its remaining energy on futile efforts to maintain a “business as usual” mentality, then the American public will squander its remaining opportunities to work together with unified purpose; to prepare for the energy crisis at hand.

Seyle’s General Adaptation Syndrome (GAS) concurs with Hamblin’s research on group disintegration. Seyle’s research demonstrates stress reactions where the intensity of stress is so great, it exceeds the organism’s maximum effective coping ability. GAS theory suggests that if stress exceeds an individual’s ability to effectively cope (for our purposes, the point of optimum societal bonding/unity) then the reaction appears to follow a three-stage process: recover or resistance, exhaustion, and burnout [114]. Seyle’s period of recovery or resistance is similar to the decreasing efficiency and effectiveness of society (evidenced by the initial declining side of the curve, Figure 2 as it clings to traditional energy practices while attempting to remediate the current energy crisis. Seyle’s, Torrance’s and Hamblin’s paradigms all concur that should stress-causing events continue unabated, exhaustion sets in, followed by symptoms of burn-out including diminished responsiveness to the needs of others [114]. Groups disintegrate [91] and as each progressive solution fails, frustration mounts, and individual attempts at survival occur [113].

8. The Power of Unified Purpose

A society with a unified vision for resolving its “real” energy issues has the capacity to alter its projected energy path [115]. Concentrated focus on a crisis situation retards social growth and can exacerbate existing calamities [116]. A clear vision of a desired outcome leads to clarity of purpose among group members, a unified collective objective, and more coordinated pooled resources to achieve the desired outcome. Only through the application of unified purpose will the U.S., as a collective, be able to mediate its voracious use of energy and effectively utilize its remaining resources to wean itself from dependency on oil. Abraham Lincoln’s comment appears salient; “You cannot escape the responsibility of tomorrow by evading it today” [117]. The current challenge for the U.S. and other energy intensive, oil driven Western cultures is to develop a shared vision for an energy independent future that:

- (1) Acknowledges the biophysical constraints of reality,
- (2) Effectively envisions the true collective objective,

- (3) Clearly states goals, and
- (4) Establishes flexible and evolving methods of implementation [118].

We suggest that unified purpose and vision would result in a comprehensive, adaptive, integrated, and biophysically-based process based on a collective understanding for reducing current and anticipated U.S. oil consumption. In practical terms, a unified purpose would provide the U.S. with a social process to determine how to best use existing natural resources, employ sustainable practices, and plan for an “energy independent” future. The actions we take today have the potential to exponentially affect the world of tomorrow. If steps are taken to avert the coming energy crisis and develop a low energy intensive society, we may still be able to avert many, and possibly all, of the above outcomes.

9. Summary

We have developed a framework for understanding possible Western societal reactions to stresses caused by the depleting quality and quantity of oil reserves by applying Boulding’s understanding of general systems theory to Janis’, Torrance’s, and Hamblin’s work on individual and small group reactions to stress. We examined past societal responses to perceived stress and possible future adaptive behaviors to energy (oil) scarcity using psychological and sociological frameworks originally designed for behavioral analysis at the individual and small group levels.

The U.S. has defined its energy security by extrapolating its current and future energy circumstances from an examination of its history. Historically, the U.S. has been capable of producing and procuring, for the last century and a half of rapid economic growth, all of the oil required for the “American way of life”. With few exceptions, it has been able to do so unfettered by the biophysical realities of finite energy resources. As a result, the U.S. populace has generally ignored scientific evidence of depleting oil reserves and remained immersed in the day-to-day minutiae of life. We suggest that, if and when serious oil shortages become a reality, three defense mechanisms: denial, establishment of scapegoats, and an increased need to affiliate are likely to be employed to facilitate the continuance of this American myth of plenty and perception of invincibility.

U.S. foreign policies in the Middle East are manifestations of the interactive effect of all three defense mechanisms. The first defense mechanism is demonstrated as denial of the severity of U.S. dependence on foreign oil from countries with whom it is on less than friendly terms and the impact of this dependency. Continuous and favorable foreign oil trade is necessary for the maintenance of the U.S. and world economic status quo. The sense of and actual vulnerability created by this dependence on favorable foreign oil trade with potentially hostile nations helps establish a second defense mechanism: the sometimes latent, sometimes active, wish to establish scapegoats on whom aggression can be expressed and blame may be placed. This de-humanizing process facilitates discriminatory injustices and is used to justify aggressive actions taken by the U.S. against individuals, groups and nations defined as flawed and inadequate. Prejudicial stereotypes and cultural intolerance, once established, permits acts of aggression to be perceived as justified and perpetrated with minimal culpability. Individuals holding and espousing similar ideologies and embracing similar stereotypes find themselves drawn to one another. This increased need to affiliate with (the third defense mechanism) and share common opinions, beliefs, and feelings with like-minded people results in the

formation of sub-groups such as political splinter groups. This shared sense of unity culminates in a “we/they” mentality, perpetuating stereotyping, scapegoating and aggression. These defense mechanisms work in concert to create an exaggerated sense of invulnerability and a willingness to assert power, in the form of military might, in order to ensure the steady flow of oil necessary to maintain the world economic status quo and a sense of entitlement and justification.

We suggest that, despite continued scientific evidence of peak oil, oil depletion, and declining EROI, the U.S. populace will continue to exhibit these psychological and sociological defense mechanisms on a broad societal scale until sufficiently clear, irrefutable evidence to the contrary brings about a shift in perception and changes in actions. As the gap between increasing U.S. oil consumption rates, declining EROI of oil, and oil depletion expands, demands for government intervention programs (designed to combat growing unemployment and poverty) will probably increase. At the same time, economic paucity and recession will result in calls for decreased government spending cutting these very programs. As a result, the division between the “haves” and “have-nots” in American society will likely bolster affiliation within sub-groups on different sides of the issue. The influence of intense and unabated individual and societal stress created by the inevitable decreasing quantity and EROI of oil will likely adversely impact the interdependencies and linkages that bind society together. The impact on communication is clear: truncated communication not only separates leaders from their populace, it limits information flow. The result is poor decision-making at a time when quick, adequate analyses of new information and circumstances coupled with clear, concise, uniform communication among all group members is essential.

Faced with seemingly impossible challenges, a dearth of solutions, and unabated stress, leadership groups, the leaders and political party in power are likely to seek expanded influence and increased structure resulting in larger, more centralized political power. The American populace, driven by fears of economic and social repercussions resulting from oil depletion, will probably experience lethargy and an unconscious desire to be guided by those in positions of power. The gravity of the impending energy crisis, and the possibility that there may not be an adequate alternative to oil, will likely result in discordance between the American populace and those in positions of leadership. It is probable that this discordance will result in disillusionment within the populace and expanded and increasingly mistrusted and maligned centralized leadership.

The capacity for the United States to alter its current and projected economic and energy course is dependent upon its leaders’ abilities to formulate and effectively communicate a clear vision and unified purpose in the energy field, establish clear renewable energy goals, commit to a rigorous energy-use reduction plan, prioritize energy research, and implement an energy policy that creates a viable energy future. The American populace will need to acknowledge the reality of biophysical constraints, and embrace a renewable, energy efficient “American way of life”.

Acknowledgements

We are grateful for the valuable assistance and constructive comments received from Susan Lambert, Bess Lyon, Timothy Mordaunt, and Kevin Stallings as well as from a series of anonymous reviewers whose sometimes negative comments, while not always in agreement with our approach or product, forced us to write what we perceive as a much better paper.

References and Notes

1. Tainter, J.A. *The Collapse of Complex Societies*; Cambridge University Press: Cambridge, UK, 1988; pp. 39-123.
2. Odum, H.T. Energy, ecology, and economics. *Energy Soc. A Spec. Issue* **1973**, *2*, 220-227.
3. Cleveland, C.J.; Costanza, R.; Hall, C.; Kaufmann, R. Energy and the U.S. economy: A biophysical perspective. *Science* **1984**, *225*, 890-897.
4. Hall, C.; Groat, A. Energy price increases and the 2008 financial crash: A practice run for what's to come? *Corp. Exam.* **2010**, *37*, 19-26.
5. *Annual Energy Review 2008, Table 1.3 Primary Energy Consumption by Source, 1949-2008*; U.S. Energy Information Administration: Washington, DC, USA, 2008.
6. Hall, C.; Klitgaard, K. *Energy and the Wealth of Nations: Understanding the Biophysical Economy*; Springer Publishing Company: New York, NY, USA, 2011; pp. 71-94.
7. Hall, C.; Day, J. Revisiting the limits to growth after peak oil. *Am. Sci.* **2009**, *97*, 230-237.
8. Gowdy, J.; Hall, C.; Klitgaard, K. The end of faith-based economics. *Corp. Exam.* **2010**, *37*, 5-11.
9. Hall, C.; Cleveland, C. Petroleum drilling and production in the United States: Yield per effort and net energy analysis. *Science* **1981**, *211*, 576-579.
10. Gagnon, N.; Hall, C.; Brinker, L. A preliminary investigation of the energy return on energy invested for global oil and gas production. *Energies* **2009**, *2*, 490-503.
11. King, C.; Hall, C. Relating financial and energy return on investment. *Sustainability* **2010**, *3*, 1810-1832.
12. Homer-Dixon, T. *Environment, Scarcity, and Violence*; Princeton University Press: Princeton, NJ, USA, 1999; pp. 29-86.
13. Inglehart, R.; Klingemann, H.-D. Genes, culture, democracy, and happiness. In *Culture and Subjective Well-being*; Diener, E., Suh, E.M., Eds.; MIT Press: Cambridge, MA, USA, 2000; pp. 165-187.
14. Lazarus, R.E.; Fulkman, S. *Stress, Appraisal, and Coping*; Springer Publishing Company: New York, NY, USA, 1984; pp. 144-285.
15. Hall, C.; Klitgaard, K. The need for a new, biophysically based paradigm in economics for the second half of the age of oil. *Int. J. Transdiscipl. Res.* **2006**, *1*, 4-22.
16. Hobföll, S.E. Conservation of resources: A new attempt at conceptualizing stress. *Am. Psychol.* **1989**, *44* 513-524.
17. Boulding, K.E. General systems theory—The skeleton of science. *Manage. Sci.* **1956**, *2*, 197-208.
18. Grosser, G.; Wechsler, H.; Greenblatt, M. *The Treat of Impending Disaster*; MIT Press: Cambridge, MA, USA, 1964; pp. 11-88.
19. Janis, I.L. *Psychological Stress*; John Wiley and Sons, Inc.: New York, NY, USA, 1958; pp. 13-199.
20. Jacobson, S.R. Individual and group response to confinement in a skyjacked plane. *Am. J. Orthopsychiatry* **1973**, *43*, 459-460.
21. Hall, C.; Cleveland, C.; Kaufmann, R. *Energy and Resource Quality: The Ecology of the Economic Process*; Wiley-Interscience: New York, NY, USA, 1986; pp. 34-68.

22. Campbell, C.; Laherrère, J. The end of cheap oil: Global production of conventional oil will begin to decline sooner than most people think, probably within 10 years. *Sci. Am.* **1998**, *278*, 78-84.
23. Freud, A. *The Ego and the Mechanisms of Defense*; Hogarth: London, UK, 1937, pp. 38-43.
24. Ayres, R.; Ayres, L.; Warr, B. Exergy, power and work in the US economy, 1900–1998. *Energy* **2003**, *28*, 219-273.
25. Ayres, R.; Warr, B. Accounting for growth: The role of physical work. *Struct. Change Econ. Dyn.* **2005**, *16*, 181-209.
26. Tertzankian, P. *A Thousand Barrels A Second: The Coming Oil Break Point and the Challenges Facing an Energy Dependent World*; McGraw-Hill: New York, NY, USA, 2006, pp. 23-58.
27. McConnell, D.; Hardemon, R.A.; Ransburgh, L.C. The logistics constant throughout the ages. *Air Force J. Logist.* **1999**, *23*, 20-23.
28. Berragan, G.W. High command and staff course staff ride paper: Who should bear primary responsibility for the culmination of Patton's US third army on the mosell in 1944? Are there lessons for contemporary campaign planning? *Def. Stud.* **2003**, *3*, 161-172.
29. Copaken, R.R. Oil as a strategic commodity. In *The New Global Oil Market: Understanding Energy Issues in the World Economy*; Shojai, S., Ed.; Praeger Publishers: Westport, CT, USA, 1995; pp. 217-224.
30. *International Energy Statistics, Crude Oil Proved Reserves (Billion Barrels)*; U.S. Energy Information Administration: Washington, DC, USA, 2009. Available online: http://tonto.eia.doe.gov/oil_gas/petroleum/info_glance/petroleum.html (accessed on 5 September 2010).
31. *World Factbook: Saudi Arabia*; U.S. Central Intelligence Agency: Washington, DC, USA, 2010. Available online: <http://www.cia.gov/library/index.html> (accessed on 19 October 2010).
32. *BP Statistical Review of World Energy, June 2010*; BP: London, UK, 2010. Available online: <http://www.bp.com/statisticalreview> (accessed on 10 December 2010).
33. Huber, M.T. The use of gasoline: Value, oil, and the "American way of life". *Antipode* **2009**, *41*, 465-486.
34. *SIPRI Yearbook 2010: Armaments, Disarmament and International Security*; Stockholm International Peace Research Institute: Solona, Sweden, 2010.
35. *Annual data from 1969 to 2009 (Table 1.1.5 Gross Domestic Product)*; U.S. Bureau of Economic Analysis: Washington, DC, USA, 2010. Available online: http://www.bea.gov/National/nipaweb2010/DownSS2_Test.htm (accessed on 29 October 2010).
36. Billon, P.L.; Khatib, F.E. From free oil to 'freedom oil': Terrorism, war, and US Geopolitics in the persian gulf. *Geopolitics* **2004**, *9*, 109-137.
37. Paust, J.J.; Blaustein, A.P. The Arab oil weapon—A threat to international peace. *Am. J. Int. Law* **1974**, *68*, 410-439.
38. Hiro, D. *Desert Shield to Desert Storm: The Second Gulf War*; Authors Choice Press: Lincoln, NE, USA, 1992; pp. 9-98.
39. Jhaveri, N.J. Petroimperialism: US oil interests and the Iraq war. *Antipode* **2004**, *36*, 2-11.
40. Hudson, M.C. To play the hegemon: Fifty years of US policy toward the middle east. *Middle East J.* **1996**, *50*, 329-343.
41. Bentley, R.W. Global oil & gas depletion: An overview. *Energy Policy* **2002**, *30*, 189-205.

42. Stern, R. Oil marketing power and United States national security. *Proc. Natl. Acad. Sci. U. S. A.* **2006**, *103*, 1650-1655.
43. Landau, M.J.; Solomon, S.; Greenberg, J.; Cohen, F.; Pyszczynski, T.; Arndt, J.; Miller, C.H.; Ogilvie, D.M.; Cook, A. Deliver US from evil: The effect of mortality salience and reminders of 9/11 on support for president George W. Bush. *Personal. Soc. Psychol. Bull.* **2004**, *30*, 1136-1150.
44. Noël, L. *Intolerance: A General Survey*; McGill-Queen's University Press: Montreal and Kingston, QC, Canada, 1994; pp. 11-76.
45. Janis, I.L. *Air War and Emotional Stress*; McGraw-Hill: New York, NY, USA, 1951, pp. 177-189.
46. Swann, C.; Pethokoukis, J. An inevitable slide for Americans' standard of living. In *The New York Times*. 7 October 2010. Available online: <http://www.nytimes.com/2010/10/08/business/08views.html?src=busln> (accessed on 19 October 2010).
47. Faunce, W.A. Automation and the division of labor. *Soc. Probl.* **1965**, *13*, 149-160.
48. Hecht, J. Classical labour-displacing technological change: The case of the US insurance industry. *Camb. J. Econ.* **2001**, *25*, 517-537.
49. Levine, L.A. *CRS Report for Congress: Offshoring (a.k.a. Offshore Outsourcing) and Job Insecurity Among U.S. Workers—RL32292*; United States Congressional Research Service: Washington, DC, USA, 2007. Available online: <http://fpc.state.gov/documents/organization/93469.pdf> (accessed on 5 December 2010).
50. Berman, E.; Bound, J.; Grilliches, Z. Changes in the demand for skilled labor with U.S. manufacturing: Evidence for the annual survey of manufacturers. *Q. J. Econ.* **1994**, *109*, 367-397.
51. Meyers, E. The causes of convergence in western immigration control. *Rev. Int. Stud.* **2002**, *28*, 123-141.
52. Mossakowski, K.N. The Influence of past unemployment duration on symptoms of depression among young women and men in the United States. *Am. J. Public Health* **2009**, *99*, 1826-1832.
53. Kiecolt, K.J. Group Consciousness and the attribution of blame for national economic problems. *Am. Polit. Res.* **1987**, *15*, 203-222.
54. Seeger, M.W. The Challenger tragedy and search for legitimacy. *Cent. States Speech J.* **1986**, *37*, 147-157.
55. Bratta, P.M. Flag display post-9/11: A disclosure on American nationalism. *J. Am. Cult.* **2009**, *32*, 232-243.
56. Parker, C.S. Symbolic versus blind patriotism: Distinction without differences? *Polit. Res. Q.* **2010**, *63*, 97-114.
57. Burney, S. Manufacturing nationalism: Post-september 11 discourse in United States media. *Stud. Media Inf. Lit. Educ.* **2002**, *2*, 1496-6603.
58. Salameh, M. *Peak Oil: A Reality or Hype?* USAEE Working Paper. Cleveland, OH, USA, 2008; pp. 5-11.
59. Mitchell, T. McJihad: Islam in the U.S. global order. *Soc. Text* **2002**, *20*, 1-18.
60. Pisarski, A.; Terra, N. American and European transportation response to the 1973-74 oil embargo. *Transportation* **1975**, *4*, 291-312.
61. Murphy, D.; Hall, C. Energy return on investment, peak oil, and the end of economic growth. *Ann. N. Y. Acad. Sci.* **2011**, *1219*, 52-72.

62. Knoop, T. *Recessions and Depressions: Understanding Business Cycles*; Praeger Publishers: Westport, CT, USA, 2004; pp. 141-190.
63. Ignotus, M. Seizing Arab oil: How the U.S. can break the oil cartel's stranglehold on the world. *Harper's Mag.* **1975**, March 1975, 45-62.
64. Carter, J. The moral equivalent of war. *Time Magazine*, 120, 1982. Available online: <http://www.time.com/time/magazine/article/0,9171,949597,00.html> (accessed on 20 March 2011).
65. Yahkelovich, D.; Kaagan, L. Assertive America. *Foreign Aff.* **1980**, 59, 696-713.
66. Newman, P.; Beatly, T.; Boyer, H. *Resilient Cities: Responding to Peak Oil and Climate Change*; Island Press: Washington, DC, USA, 2009; pp. 15-34.
67. Belk, R.; Painter, J.; Semenik, R. Preferred solution to the energy crisis as a function of causal attributions. *J. Consum. Res.* **1981**, 8, 306-312.
68. Yahkelovich, D. *Coming to Public Judgment: Making Democracy Work in a Complex World*; Syracuse University Press: Syracuse, NY, USA, 1991; pp. 115-137.
69. Farhar, B. The polls-poll trend: Public opinion about energy. *Public Opin. Q.* **1994**, 58, 603-632.
70. Abrahamian, E. Mass Protests in the Iranian Revolution, 1977-79. In *Civil Resistance and Power Politics: The Experience of Non-violent Action from Ghandhi to the Present*; Roberts, A., Ash, T.G., Eds.; Oxford University Press Inc.: New York, NY, USA, 2009; pp. 162-178.
71. Fernández, D. Cuba in the Middle East. In *Cuban Foreign Policy: The New Internationalism*; Suchlicki, J., Fernandez, D., Eds.; University of Miami: Miami, FL, USA, 1985; pp. 127-174.
72. Hufker, B.; Cavender, G. From freedom flotilla to America's burden: The social construction of the mariel immigrants. *Sociol. Q.* **1990**, 31, 321-335.
73. Harris, L. Soviet invasion of Afghanistan angers Americans. *ABC News-Harris Surv.* **1980**, 2, 1-4.
74. Carter, J. *State of the Union Address 1980*; Department of State, Bureau of Public Affairs: Washington, DC, USA, 1980.
75. Meacher, M. Our Only Hope Lies in Forging a New Energy World Order. *The Telegraph*, 26 June 2006. Available online: <http://www.telegraph.co.uk/finance/2941858/Our-only-hope-lies-in-forging-a-new-energy-world-order.html> (accessed on 18 April 2011)
76. Jhaveri, N. Petroimperialism: US oil interests and the Iraq War. *Antipode* **2004**, 36, 2-11.
77. Farhar, B.C. Trends in US public perception and preferences on energy and environmental policy. *Annu. Rev. Energy Environ.* **1994**, 19, 211-239.
78. Torrance, E.P. Small groups under stress conditions. *Am. Sociol. Rev.* **1954**, 19, 751-755.
79. Selye, H. Confusion and controversy in the stress field. *J. Hum. Stress* **1975**, 1, 37-44.
80. Petrullo, L.; Bass, B.M. *Leadership and Interpersonal Behavior*; Holt, Rinehart and Winston: New York, NY, USA, 1961; pp. 104-113.
81. Diamond, J. Easter's End. *Discover Magazine*, 1 August 1995. Available online: <http://discovermagazine.com/1995/aug/eastersend543> (accessed on 15 March 2011).
82. Goldsworthy, A. *How Rome Fell*; Yale University Press: New Haven, CT, USA, 2009; pp. 11-154.
83. Copeland, D.C. *The Origins of Major War*; Cornell University Press: Ithaca, NY, USA, 2001; pp. 11-34.
84. Wade, R. *Village Republics, Economic Conditions for Collective Action in South India*; Cambridge University Press: Cambridge, UK, 1987.

85. Hanoch, Y.; Vitouch, O. When less is more: Information, emotional arousal and the ecological reframing of the Yerkes-Dodson Law. *Theory Psychol.* **2004**, *14*, 427-452.
86. Baldi, E.; Bucherelli, C. The inverted “U-Shaped” dose-effect relationships in learning and memory: Modulation of arousal and consolidation. *Nonlinearity Biol. Toxicol. Med.* **2005**, *3*, 9-21.
87. Marshal, S.L.A. *Men Against Fire: The Problem of Battle Command*; William Morrow & Co.: New York, NY, USA, 1947; pp. 123-137.
88. Torrance, E.P. Techniques for studying individual and group adaptation in emergencies and extreme conditions. In *Air Force Human Engineering Personnel, and Training Research*; Finch, F., Cameron, F., Alfred, A., Eds.; Knopf Inc.: Washington, DC, USA, 1956; pp. 286-297.
89. Ziller, R.C. Scales of judgment: A determinant of the accuracy of group decisions. *Hum. Relat.* **1955**, *8*, 153-164.
90. Torrance, E.P. Some consequences of power differences on decision making in permanent and temporary three-man groups. In *Small Groups: Studies in Social Interaction*, Revised ed.; Hare, A.P., Borgatta, E.F., Bales, R.F., Eds.; Alfred A. Knopf Inc.: New York, NY, USA, 1965; pp. 600-609.
91. Torrance, E.P. Group decision—Making and disagreement. *Soc. Forces* **1957**, *35*, 314-318.
92. Gouran, D.S. The watergate cover-up: Its dynamics and its implications. Speech Communication Association: Houston, Texas, United States of America, 27 December 1975. Available online: <http://eric.ed.gov:80/PDFS/ED112443.pdf> (accessed on 17 March 2011)
93. Vandenbroucke, L.S. Anatomy of a failure: The decision to land at the Bay of Pigs. *Polit. Sci. Q.* **1984**, *99*, 471-491.
94. ENSR International. *Avoiding and Resolving Intergovernmental Conflicts with Interstate Natural Gas Facility Siting, Construction, and Maintenance*; The INGAA Foundation, Inc.: Washington, DC, USA, 2005.
95. German, B. *EPA and the Pentagon: A Failure to Communicate on Superfund Cleanups*. The Hill: Washington, DC, 17 August 2010. Available online: <http://thehill.com/blogs/e2-wire/677-e2-wire/114627-epa-and-the-pentagon-a-failure-to-communicate-on-superfund-cleanups> (accessed on 20 September 2010).
96. Burnham, M. *China's A-Power to Build U.S. Wind Turbines Factory*. The New York Times: New York, NY, USA, 17 November 2010. Available online: <http://www.nytimes.com/gwire/2009/11/17/17greenwire-chinas-a-power-to-build-us-wind-turbine-factor-22742.html> (accessed on 9 October 2010).
97. Staw, B.M.; Sandelands, L.E.; Dutton, J.E. Threat rigidity effects in organizational behavior: A multilevel analysis. *Adm. Sci. Q.* **1981**, *26*, 501-524.
98. Seeger, M.W.; Sellnow, T.L.; Ulmer, R.R. *Communication and Organizational Crisis*; Praeger Publishers: Westport, CT, USA, 2003; pp. 105-124.
99. Katz, R. The influence of group conflict on leadership effectiveness. *Organizational Behavior & Human Performance* **1977**, *20*, 265-286.
100. Gemmill, G. The Mythology of the Leader Role in Small Groups. *Small Group Research* **1986**, *17*, 41-50.
101. Hamblin, R.L. Leadership and crises. *Sociometry* **1958**, *21*, 322-335.

102. Conrath, D.W. Communications environment and its relationship to organizational structure. *Manage. Sci.* **1973**, *20*, 586-603.
103. Asch, S.E. Opinions and social pressure. *Sci. Am.* **1955**, *193*, 31-35.
104. Kitchen, M. *A History of Modern Germany 1800-2000*; Blackwell Publishing: Oxford, UK, 2006; pp. 203-315.
105. Meier, C.C. Caesar Divi filius and the formation of the alternative in Rome. In *Between Republic and Empire: Interpretations of Augustus and His Principate*; Kurt, A., Raaflaub, A., Toher, M., Eds.; University of California Press, Ltd.: Berkeley, CA, USA, 1990; pp. 54-70.
106. Brown, H.G. Ending the french revolution: Violence, justice, and repression for the terror to napoleon. *J. Interdiscip. Hist.* **2008**, *38*, 453-461.
107. Rath, J.; Schum, C.W. Fascist or authoritarian? In *Social Roots of European Fascism*; Larsen, S.U., Hagtvet, B., Myklebust, J.P., Eds.; Universitetsforlaget: Bergen, Norway, 1980; pp. 249-256.
108. Tyre, M.J.; Hippel, E. The situated nature of adaptive learning in organizations. *Organ. Sci.* **1997**, *8*, 71-83.
109. Groll, M. *Vietnam War Coverage on U.S. Television News Casts*; Munich, GRIN Publishing GmbH: Munich, Germany, 2004; pp. 7-15.
110. Allen, J. From morse to modem: Developments in transmission technologies and their impact upon the military-media relationship. In *War, Culture, and the Media: Representations of the Military in 20th Century*; Stewart, I., Carruthers, S.L., Eds.; Associated University Presses: Cranbury, NJ, USA, 1996; pp. 148-164.
111. *Alternative & Advanced Fuels, Alternative Fuels & Advanced Vehicles Data Center*; U.S. Department of Energy, Energy Efficiency & Renewable Energy: Washington, DC, USA, 2010. Available online: <http://www.afdc.energy.gov/afdc/fuels/index.html> (accessed on 9 October 2010).
112. Special Issue "New Studies in EROI (Energy Return on Investment)". Hall, C.A.S., Ed.; *Sustainability*, in press. Available online: http://www.mdpi.com/journal/sustainability/special_issues/New_Studies_EROI/.
113. Hamblin, R.L. Group integration during a crisis. *Hum. Relat.* **1958**, *11*, 67-76.
114. Selye, H. The General-Adaptation-Syndrome. *Annu. Rev. Med.* **1951**, *2*, 327-342.
115. Rothbaum, F.; Weisz, J.R.; Snyder, S.S. Changing the world and changing the self a two-process model of perceived control. *J. Personal. Soc. Psychol.* **1982**, *42*, 5-37.
116. Weick, K.E. Enacted sensemaking in crisis situations. *J. Manage. Stud.* **1988**, *25*, 305-317.
117. McLellan, V.K. *Wise Words and Quotes*; Alive Communication Inc.: Colorado Springs, CO, USA, 1996; p. 229.
118. Costanza, R. Visions of alternative (unpredictable) futures and their use in policy analysis. *Conserv. Ecol.* **2000**, *4*, 1-5. Available online: <http://www.ecologyandsociety.org/vol4/iss1/art5/>. (accessed on 6 November 2011).

Article

Implications of Energy Return on Energy Invested on Future Total Energy Demand

Shinuo Deng and George R. Tynan *

Center for Energy Research and Department of Mechanical and Aerospace Engineering UCSD,
9500 Gilman Drive, La Jolla, CA 92093, USA

* Author to whom correspondence should be addressed; E-Mail: gtynan@ucsd.edu;
Tel.: +1-858-534-9724; Fax: +1-858-534-7716.

*Received: 5 January 2011; in revised form 10 July 2011 / Accepted: 10 November 2011 /
Published: 13 December 2011*

Abstract: Human society is now at the beginning of a transition from fossil-fuel based primary energy sources to a mixture of renewable and nuclear based energy sources which have a lower Energy Return On Energy Invested (EROEI) than the older fossil based sources. This paper examines the evolution of total energy demand during this transition for a highly idealized energy economy. A simple model is introduced in which the net useful energy output required to operate an economy is assumed to remain fixed while the lower EROEI source gradually replaces the older higher EROEI primary energy source following a logistics substitution model. The results show that, for fixed net useful energy output, total energy demand increases as the ratio $EROEI_{new}/EROEI_{old}$ decreases; total energy demand diverges as $EROEI_{new}$ approaches unity, indicating that the system must collapse in this limit.

Keywords: EROEI; energy demand; total energy demand

1. Introduction

Energy plays a critical role in enabling and sustaining human societies and is subject to strict physical conservation laws arising from thermodynamics. Human society is now at the beginning of a transition from fossil-fuel based primary energy sources to a mixture of renewable and nuclear based energy sources which have a lower Energy Return On Energy Invested (EROEI) than the older fossil

based sources. Thus the impact of this transition on total energy demand is of particular interest. In this paper we examine this issue using a highly idealized and simplified model to illustrate the essential impacts that EROEI has on energy demand.

Suppose that the *net* useful energy, E_{net} that is required to operate an economy is constant over time, and this useful net energy is obtained from an energy “system” as illustrated in Figure 1. Here the term system is used to denote the collection of equipment, transportation and distribution networks and people that is required to extract, refine and deliver energy in a form that can be used by human society.

Figure1. Schematic of an energy system.

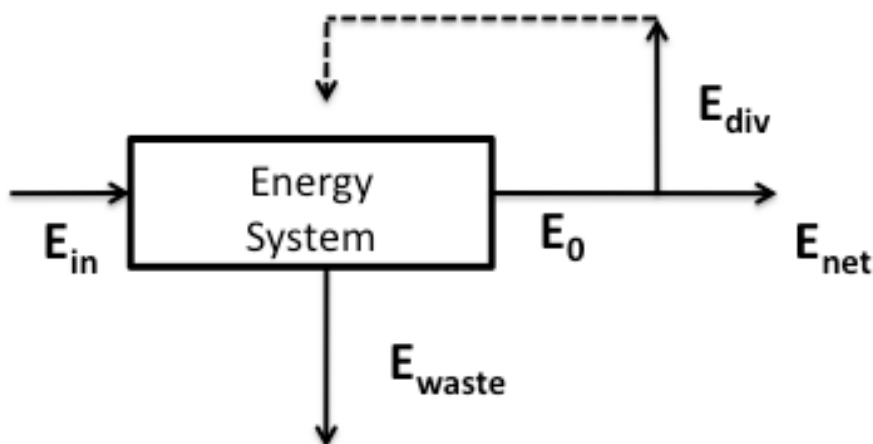

In this schematic system, E_{in} is the primary energy input from an external source (e.g., the thermal energy content of a stored energy resource like coal, petroleum, natural gas, or fissile material, or the energy input acquired from the power input from the environment, integrated over the lifetime of the system in the case of renewable energy sources). Note that this energy has a high enthalpy or quality and thus can be converted into useful form economically. This energy is delivered to the system, which then converts some of this energy input into either useful output energy, denoted as E_o , or into an energy waste stream, E_{waste} , which denotes the waste energy which is rejected from the system to the environment (usually in the form of heat).

The energy system itself requires some input of useful energy in order to function (e.g., the extraction of petroleum and subsequent refining and delivery of fuel products requires a significant input of useful energy which is then no longer available to meet other human needs; the location, extraction, refining and enrichment of fissile material requires an energy input; the manufacture of wind turbines, solar thermal and/or solar photovoltaic systems requires an up-front energy investment). We can account for this energy cost using this simplified model by noting that out of the useful output energy, E_o , some useful energy E_{div} must be diverted for use in creating and operating the energy system itself. This diverted energy would include e.g. the energy cost to extract, refine, transport and deliver fuels such as gasoline, diesel, enriched fissile material and so forth, along with any up-front energy costs to build the apparatus that provides these fuels from raw feedstock. For renewable systems, the diverted energy includes the energy cost to build, install and maintain the system over its life, along with the energy cost of the energy delivery and ancillary energy storage systems (e.g., batteries) that may accompany the adoption of renewable sources. This diverted energy is dissipated as

low grade heat by the creation and operation of the energy system and, as a result, it is not available to further productive use. Thus the quantity E_{net} is left and represents the net useful energy available to meet the remainder of human energy needs (e.g. the electrical energy, fuel energy content, or useful high grade heat) required for all other industrial, commercial, agricultural and domestic uses.

At this point it is important to note the relationship and distinction between EROEI and conversion efficiency, η . This latter efficiency is usually defined as $\eta = \frac{W}{E_{fuel}}$ where E_{fuel} denotes the stored energy content of some refined fuel product (e.g., gasoline, diesel, enriched fissile material, and so on) and W denotes the useful work output from the conversion apparatus. Note that, unlike the EROEI discussion above, the energy cost to refine and deliver the fuel to the point of use is not considered in the calculation of efficiency. The efficiency is limited to a value that is less than unity by the physics of the system conversion apparatus (e.g. for a heat engine it is limited by the engine's thermodynamic cycle, materials limits and/or combustion temperature of the fuel; in other conversion engines such as fuel cells other quantities determine the conversion efficiency). Referring to Figure 1, the quantity E_{fuel} would then correspond to the energy content of the refined fuel, which is produced by the energy system and would thus be denoted as E_{net} in Figure 1.

The EROEI and system efficiency do become linked when considering renewable energy systems. In such systems, there is an up-front energy cost or investment that must be made in order to create the system and install it in a location where it can then generate useful energy. The conversion efficiency for such renewable systems is then usually defined in terms of a ratio of power input and output, *i.e.*, $\eta_{renew} = \frac{P_{out}}{P_{in}}$ where P_{out} denotes the output power of the system while P_{in} denotes the power input into the system from nature (ultimately obtained from solar irradiation). The EROEI of such a system is then defined by the energy output of the renewable system, integrated over the system lifetime, divided by the energy cost of the system. Obviously in this case efficiency does enter into the EROEI estimate, as does the lifetime and up front energy cost of the system.

In this article we are *not* examining the role of conversion efficiency as such in energy systems. Instead, we are focusing on the energy required to harvest either stored or incoming energy and convert it into useful form, and then look at the effect of the EROEI on total energy demand.

With these considerations in mind, the net useful energy available for needs other than the energy system itself, E_{net} , can be expressed in terms of the energy system output energy, E_o , and the diverted energy, E_{div} as

$$E_{net} = E_o - E_{div} \quad (1)$$

We now define the energy returned on energy invested (EROEI), E_R , as the ratio

$$E_R = \frac{E_o}{E_{div}} \quad (2)$$

Comparing this expression to the definition of efficiency given earlier, the distinction between the two concepts should become clearer: EROEI is a measure of how much of the useful energy delivered by the system must be diverted or otherwise used to create and operate the energy system and, as has been argued elsewhere [3], plays a crucial role in the sustainability of human civilization.

Energy into and out of the system must be conserved. Thus we can write an energy balance on the system

$$E_{in} + E_{div} = E_{waste} + E_0 \quad (3)$$

and we can use equation (1) to then re-write this as

$$E_{in} = (E_{waste} - E_{div}) + (E_{net} + E_{div}) \quad (4)$$

We are interested in developing an expression relating the net energy output of the system and the energy input to the system. Thus we write this as

$$E_{in} > E_{net} + E_{div} = E_{net} \left(1 + \frac{E_{div}}{E_{net}} \right) \quad (5)$$

where the inequality arises by noting that $E_{waste} \geq E_{div}$, i.e., waste energy stream dissipated by the energy system is at least as large as the diverted energy input into the energy system due to the fact that the diverted energy used to operate the energy system is ultimately dissipated as heat. Using equation (1), this inequality can be re-arranged to give

$$E_{in} > E_{net} \left(1 + \frac{E_{div}}{E_0 - E_{div}} \right) \quad (6)$$

Using equation (2) for the definition of EROEI, we can re-arrange this expression to give

$$E_{in} > E_{net} \left(1 + \frac{1}{E_R - 1} \right) \quad (7)$$

This expression can be re-written as

$$E_{in} > E_{net} \left(\frac{E_R}{E_R - 1} \right) \quad (8)$$

which is the final relation that provides a *lower bound* on the energy E_{in} that *must* be extracted from nature in order to provide a quantity E_{net} of useful energy for human needs using an energy system that has an EROEI given by E_R . Note that when $E_R \rightarrow 1$ then the energy input E_{in} required to provide a finite net energy demand E_{net} then diverges to infinity. Obviously in this case the system will then breakdown.

2. Technology Substitution Model

Technology substitutions, in which a new solution to a human need is gradually adopted and replaces an older solution, can often be modeled with a logistics model as shown by Fischer and Pry [1] in which the market fraction f of a new primary energy source starts small, grows and then eventually saturates. As shown by Fischer and Pry, $f(t)$ satisfies the logistics equation $\frac{df}{dt} = r_0 f(1-f)$ and has the form [1]:

$$f(t) = \frac{1}{1 + e^{-r_0(t-t_0)}} \quad (9)$$

where r_0 denotes the growth rate at early time, when $f \ll 1$, and t_0 denotes the time when $f = 0.5$, i.e., when the technology has reached 50% of the ultimate final market potential (when $f = 1$). Note that the model breaks down for very early times ($t \ll 0$) since it predicts $f(t) > 0$ in such a case. However, once f becomes larger than about 0.01, the model has been able to accurately capture many technology substitutions that occurred in the 20th century. Figure 2 below illustrated the market evolution over time.

Figure 2. Market Penetration vs. time.

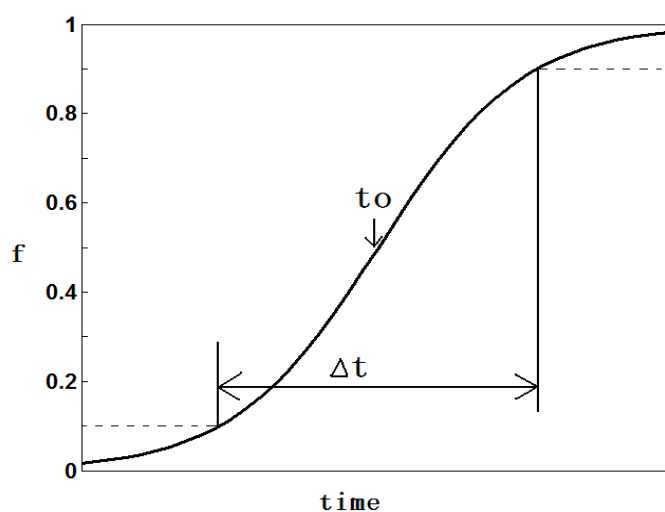

The time when the market penetration, f , reaches 0.5 is called as the mid-point time, t_0 , while the time for f to go from 0.1 to 0.9 is defined as the “takeover time”, Δt . An examination of the solution $f(t)$ given in equation (9) shows that the takeover time Δt is set by the early growth rate, r_0 , and is given as $\Delta t \approx \frac{4.4}{r_0}$. Marcelli *et al* [2] have shown that primary energy substitutions in the 19th and 20th century have also followed this model. The typical replacement times have been in the range of 40–60 years, corresponding to early time market fraction grow rates in the range of 7–10% per annum. A number of more recent studies of energy substitutions can also be found [2-18]; although there does not appear to be clear consensus on the utility of the logistics model, many authors use this model or a variant thereof in examining energy transitions. Thus for the purposes of this paper, which seeks to isolate and examine the effect on total energy demand precipitated by a transition from a high EROEI primary energy source to a lower EROEI source, we shall assume that the transition follows this model.

3. Idealized Model of an Energy System in Transition

Our goal in this article is to clearly isolate and highlight the impact that a transition from a higher EROEI primary energy source to a new source that has a lower EROEI has on the required total energy input from nature. Thus let us consider that we have an energy substitution occurring in which a new primary energy source is replacing an old primary energy source. Each energy system can be described schematically via the energy flows described above and, together, the two energy sources provide the net energy, E_{net} , required for useful purposes by human beings.

Figure 3 below provides a schematic of this system. Here E_{R1} denotes the EROEI of the old primary source, and E_{R2} denotes the EROEI of the new primary source. They are both assumed to be constant with time and larger than 1. We assume that an energy substitution is underway, such that f_2 can be described by the expression given earlier for $f(t)$. Furthermore in this idealized model we assume that there are only two primary energy sources available, such that $f_1(t) + f_2(t) = 1$. Thus as the new energy source is adopted, the older source market fraction decreases. To further simplify the model, let us assume that the total net energy, E_{net} , is fixed, but the source of this net energy gradually shifts from the first to the second primary energy sources. Note that this clearly disagrees with real human energy demand, which is growing at $\sim 1\text{--}2\%$ per year. However, we adopt this assumption here to clearly illustrate the impact that an energy transition to lower EROEI sources has on human demand for energy from the natural world. Increases in net energy demand will simply force a further increase on the energy inputs above those identified here.

Figure 3. Systems 1 and 2 represent the old and new energy system, respectively.

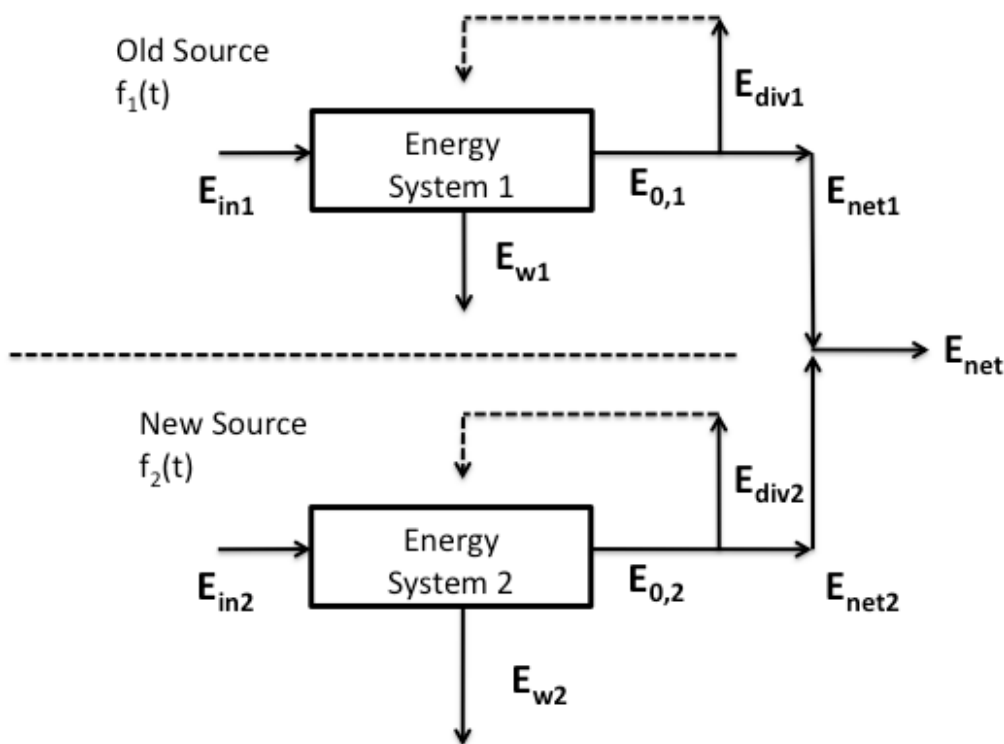

With these issues in mind, we can write energy balances for the two systems in a manner analogous to the above energy balance. Defining the total energy input from either stored energy reserves or from the environment (in the case of renewable primary energy sources) as $E_{tot} = E_{in_1} + E_{in_2}$ we can then write E_{tot} in terms of the market fraction and EROEI of each energy source as

$$\frac{E_{tot}}{E_{net}} \geq (1 - f_2) \left(\frac{E_{R1}}{E_{R1} - 1} \right) + f_2 \left(\frac{E_{R2}}{E_{R2} - 1} \right) \quad (10)$$

which forms the primary result we are interested in. Here $f_2(t)$ follows the substitution model given above, and $f_1 = 1 - f_2$.

Let us examine the behavior of this solution. Taking E_{R1} as a free parameter, at time long after t_0 (for example, when the transition is nearly completed with $f_2 = 0.8$), the variation of E_{tot}/E_{net} vs. E_{R2}/E_{R1} is shown in Figure 4. We find that if E_{R1} is larger than E_{R2} (which is the case for the transition from high quality fossil fuels to replacement liquid fuel sources), then E_{tot} , normalized by E_{net} , (which is assumed fixed in this idealization) will increase as the ratio of E_{R2}/E_{R1} decreases as shown in the figure. For example, if an old high EROEI source with $E_{R1} = 10$ is replaced with a source with $E_{R2} = 2$ then for fixed net energy demand, the energy input from nature must roughly double. If $E_{R2} \sim 1.3\text{--}1.5$ as e.g. for many proposed biofuels, then the energy input will be 3–4 times higher than for the higher EROEI source.

Figure 4. Plot of E_{tot}/E_{net} vs. ratio of EROEI, E_{R2}/E_{R1} for several values of E_{R1} .

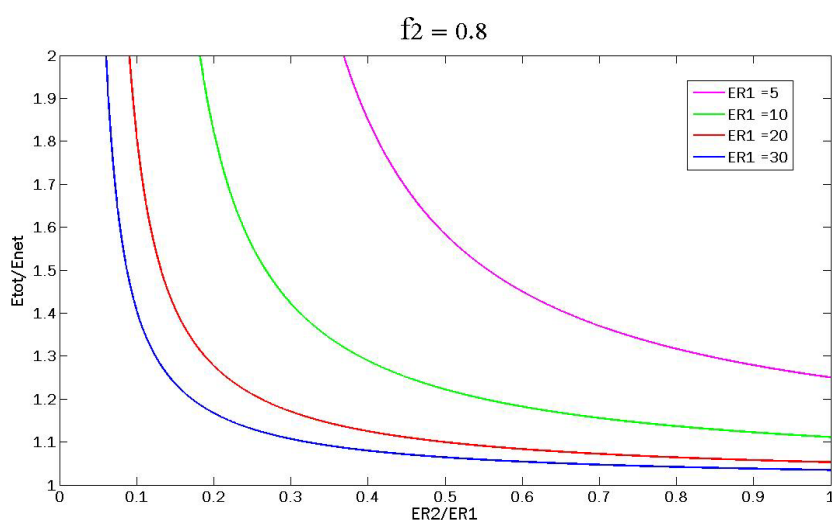

We can also examine the time variation of the energy input using this simple model. In order to do this, we take E_{R2}/E_{R1} as a free parameter and fix E_{R1} (in this case $E_{R1} = 30$ is chosen, roughly comparable to recent values for fossil fuels). In this case, the time evolution of E_{tot}/E_{net} then can be found as shown in Figure 5.

Figure 5. Time Evolution for different E_{R2}/E_{R1} ratios.

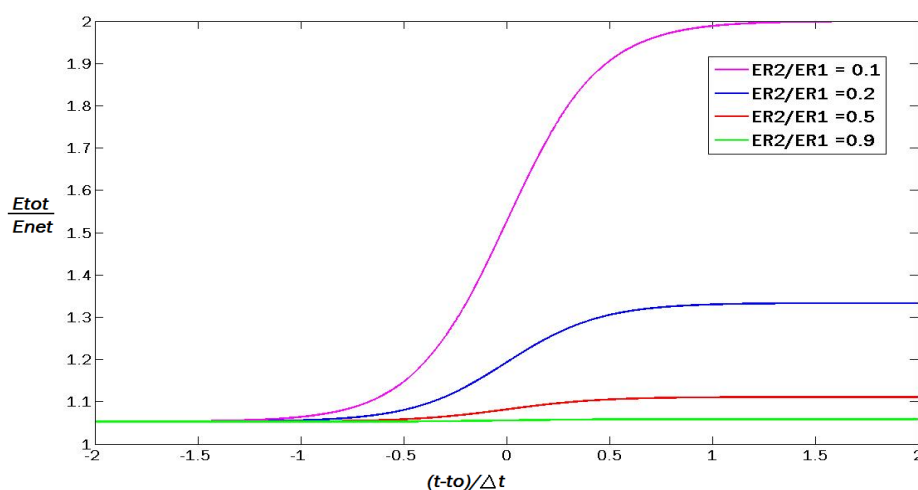

The results show that if $E_{R1} > E_{R2}$, then E_{tot} will increase as the new energy source is taking over the market. The timescale for this change is simply the replacement time Δt which historically [2] has been in the range of 40–60 years for other primary energy source transitions.

4. Application and Discussion

Estimates [19] for the EROEI of several primary energy sources and fuels currently used or being considered for the future are listed in Table 1. We can apply these results to the generation of electrical energy by considering the relative EROEI for coal and natural gas (which currently dominate electricity production worldwide) and new electrical energy sources such as nuclear, solar PV, hydropower or wind. A shift from coal (with an EROEI ranging from 50–80) to nuclear fission (with an EROEI of 5–15) gives a ratio of new EROEI to old EROEI ranging from approximately 0.05 to 0.3. Referring to Figure 5, we then see that the total energy input that must be extracted from nature would be expected to increase by a value ranging from 20–30% up to values of 200–300%. The precise value depends on the exact EROEI taken for the coal and fission systems. Similarly, the replacement of coal-produced electricity with a renewable source such as solar PV will give a ratio of EROEI values ranging from 0.1–0.2, which gives a total energy demand increase of 30–200%. Furthermore we note that the manufacture of the solar PV systems will require an up-front energy investment, which is then returned over the life of the system; provision of this upfront energy demand would then likely occur from fossil fuel systems. The impact of this energy capital investment on near term fossil fuel energy demand is important, but also goes beyond the scope of this paper. One can easily use the values given in Table 1 and Figures 4 and 5 to estimate the impact and evolution of other electrical energy substitutions.

Table 1. EROEI for energy sources and fuels. Values taken from reference [19].

Fuel	Coal	Oil	Gas	Ethanol	Biodiesel	Nuclear	Solar PV	Hydropower	Wind
EROEI	50–80	20–40	15–25	1–1.5	1.5–3	5–15	8–10	20–40	15–25

Another critical energy substitution that may occur in the coming decades is the replacement of petroleum-based liquid fuels with biologically-produced liquid fuels such as ethanol and biodiesel. Using the estimated EROEI values in Table 1 and the results of Figure 5, we can estimate the growth in total energy input need to provide a fixed transportation energy demand. The results suggest that substitution of ethanol or biodiesel for petroleum-based fuels will raise E_{tot} by 50–600% to meet a fixed demand for liquid transportation fuels. Especially in the case of ethanol, whose EROEI is close to 1, E_{tot} increases nearly six times. Clearly such a substitution will result in substantial increases in the costs for such fuels, and may also force limits on the overall production in the future.

5. Conclusion

The effect of EROEI on total energy input to a human-produced energy system in which the net useful energy demand is fixed in time is studied. Replacement of higher EROEI sources with lower EROEI sources results in an increase in the total energy input. Using published EROEI estimates for existing and new primary energy sources, we estimate that total energy inputs will need to increase by

a minimum of 40% (and could increase by as much as 400%) to provide a fixed net useful energy for human societies. Growth in net useful energy demand will further increase these estimates. The timescale for these increases is given by the primary energy source replacement time, which historically has ranged from 30–50 years. Near-term production of the energy systems (e.g., solar panels, wind turbines, fission power plants) needed to convert these new primary energy sources to usable forms will force further increases in near-term energy demand; these effects have not been included here and will also put further upward pressure on net energy demand.

References and Notes

1. Fisher, J.C.; Pry, R.H. Simple substitution model of technological change. *Technol. Forecast. Soc. Chang.* **1971**, *3*, 75-88.
2. Marchetti, C. Primary energy substitution models—Interaction between energy and society. *Technol. Forecast. Soc. Chang.* **1977**, *10*, 345-356.
3. Philipson, L.L. Market penetration models for energy-production devices and conservation techniques. *Technol. Forecast. Soc. Chang.* **1978**, *11*, 223-236.
4. Warren, E.H. Solar-energy market penetration models—Science or number mysticism. *Technol. Forecast. Soc. Chang.* **1980**, *16*, 105-118.
5. Bodger, P.S.; Tay, H.S. Logistic and energy substitution models for electricity forecasting—A comparison using New-Zealand consumption data. *Technol. Forecast. Soc. Chang.* **1987**, *31*, 27-48.
6. Silvennoinen, P.; Vaananen, J. Forecasting technological substitution—The logistic model of energy-systems revisited. *Technol. Forecast. Soc. Chang.* **1987**, *32*, 273-280.
7. Prai, L. Projections for energy mix in India. *J. Sci. Ind. Res.* **1989**, *48*, 5-7.
8. Coppola, L.; Marschoff, C.M. Technology substitution in the energy market—A one-to-one competition approach. *Energy* **1993**, *18*, 273-280.
9. Reddy, A.K.N.; Reddy, B.S. Substitution of energy carriers for cooking in Bangalore. *Energy* **1994**, *19*, 561-571.
10. Reddy, B.S. A multilogit model for fuel, shifts in the domestic sector. *Energy* **1995**, *20*, 929-936.
11. Kwasnicki, W.; Kwasnicka, H. Long-term diffusion factors of technological development: An evolutionary model and case study. *Technol. Forecast. Soc. Chang.* **1996**, *52*, 31-57.
12. DeCanio, S.J.; Laitner, J.A. Modeling technological change in energy demand forecasting—A generalized approach. *Technol. Forecast. Soc. Chang.* **1997**, *55*, 249-263.
13. Grubler, A.; Nakicenovic, N.; Victor, D.G. Modeling technological change: Implications for the global environment. *Annu. Rev. Energ. Environ.* **1999**, *24*, 545-569.
14. Grubler, A.; Nakicenovic, N.; Victor, D.G. Dynamics of energy technologies and global change. *Energy Policy* **1999**, *27*, 247-280.
15. Knapp, K.E. Exploring energy technology substitution for reducing atmospheric carbon emissions. *Energy J.* **1999**, *20*, 121-143.
16. Masini, A.; Frankl, P. Forecasting the diffusion of photovoltaic systems in southern Europe: A learning curve approach. *Technol. Forecast. Soc. Chang.* **2003**, *70*, 39-65.
17. Riahi, K.; Rubin, E.S.; Taylor, M.R.; Schrattenholzer, L.; Hounshell, D. Technological learning for carbon capture and sequestration technologies. *Energy Econ.* **2004**, *26*, 539-564.

Sustainability **2011**, *3*

18. Lund, P.D. Exploring past energy changes and their implications for the pace of penetration of new energy technologies. *Energy* **2010**, *35*, 647-656.
19. Hall, C.A.S.; Balogh, S.; Murphy, D.J.R. What is the minimum EROI that a sustainable society must have? *Energies* **2009**, *2*, 25-47.

© 2011 by the authors; licensee MDPI, Basel, Switzerland. This article is an open access article distributed under the terms and conditions of the Creative Commons Attribution license (<http://creativecommons.org/licenses/by/3.0/>).

Article

Deriving an Improved Dynamic EROI to Provide Better Information for Energy Planners

Ioannis N. Kessides ^{1,*} and David C. Wade ²

¹ The World Bank, 1818 H Street, NW, Washington, DC 20433, USA

² Argonne National Laboratory, 9700 S. Cass Avenue, Argonne, IL 60439, USA

* Author to whom correspondence should be addressed; E-Mail: ikessides@worldbank.org;
Tel.: +1-202-473-9345.

*Received: 10 January 2011; in revised form: 4 August 2011 / Accepted: 1 September 2011 /
Published: 8 December 2011*

Abstract: The two most frequently quantified metrics of net energy analysis—the energy return on (energy) investment and the energy payback period—do not capture the growth rate potential of an energy supply infrastructure. This is because the analysis underlying these metrics is essentially static—all energy inputs and outputs are treated the same, regardless of where they occur in the life cycle of the infrastructure. We develop a dynamic energy analysis framework to model the growth potential of alternative electricity supply infrastructures. An additional figure of merit, the infrastructure doubling time, is introduced. This metric highlights the critical importance of the time phasing of the initial energy investment for emplacing a given infrastructure, as opposed to the ongoing O&M energy expenditures, for the infrastructure’s growth potential. The doubling time metric also captures the influence of capacity factor, licensing and construction time lags.

Keywords: doubling time; dynamic EROI; sustainability; net energy

1. Introduction

The world is facing an enormous energy challenge. Concerns about the rate of depletion of the more readily accessible fossil fuel resources, energy security, and climate change, are giving rise to a raging policy debate at the global level. A number of energy sources and technological options are being

examined and actively pursued. However, there are highly divergent views on the constraints and opportunities associated with all of these options. Consequently, the energy environment remains opaque and uncertain. There have been persistent questions, for example, as to whether some of the energy options (e.g., corn-based ethanol) produce less energy than they consume (directly plus indirectly). These concerns in turn have generated renewed interest in net energy analysis. In particular, recent work has produced new perspectives, deeper insights, and more careful calculations of the energy return on (energy) investment (*EROI*), and the energy pay back period (τ_1)—two of the most frequently quantified metrics of net energy and life cycle analysis. Research efforts during the past few years have focussed on: evaluating the potential impacts of a declining *EROI* on economic activity [1]; calculating the minimum *EROI* for a sustainable society [2]; providing a systematic review of what is known about the *EROI* and τ_1 of major fossil fuels and renewable resources [3-7]; and analyzing the measurement errors associated with current estimates of the *EROI* [8].

There is also an ongoing debate about the ability of renewable generating technologies for scaling to materiality—*i.e.*, scaling to the terawatt level [9-11]. This is an important consideration, because global electricity demand is projected to almost double from around 16,000 TWh in 2007 to just under 29,000 TWh in 2030. Over 80% of that growth is projected to come from developing countries. The compound average growth rate of demand between 2007 and 2030 is estimated to be around 2.5% per annum for the world as a whole (1% for OECD and 3.9% for non-OECD countries). Such a growth rate might, at first glance, appear to be modest. However, the base is substantial—so the implied absolute increase in demand is huge. To put things into perspective: In 2007, global electricity generation capacity was around 4,500 GW. By 2030 it is projected to increase to just under 8,000 GW. This would be equivalent to adding 3.5 countries like the US (1039 GW) or 5 continents like OECD-Europe (847 GW) to the electricity supply pool [12].

The life cycle parameters derived from net energy analysis are helpful in assessing energy systems on the basis of energetics—*i.e.*, in terms of energy input and output over their lifetime. As such, they are useful in comparing alternative energy systems in terms of their use of society's productive resources for delivering a given amount of energy, and ultimately, in terms of their efficiency. However, the conventional energy analysis is essentially static. All energy inputs and outputs are treated the same, regardless of where they occur temporally in the life cycle of the energy technology [13]. The underlying equations of such analysis do not have a transient term. This limits the potential role of net energy analysis in energy planning where human preferences in energy use across time should properly be taken into account.

This paper develops a model describing the dynamic behavior of an energy facility (or a technology) under a plowback constraint—*i.e.*, a certain fraction of the facility's (or technology's) power output is plowed back into the self-replicating construction of new facilities and their associated resource supply and delivery infrastructures, while the rest of its output is made available to meet society's active energy demand. The requirement that each energy technology makes a contribution towards the national energy demand besides taking care of its own expansion (and thus avoids being a net energy sink) [14] is motivated by the tight demand and supply balance facing most countries around the world. Our dynamic energy analysis indicates that the single numerical values of life cycle energy metrics, *EROI* and τ_1 , are not sufficient for assessing the capacity of a given infrastructure to support rapid growth rates.

It is important to understand the "structure" and time dependencies of the energy investments required for emplacing and maintaining such an infrastructural facility. For this we propose and derive a third metric, the Doubling Time, τ_2 , which clarifies the way in which certain physical characteristics (e.g. the intermittency and low conversion efficiency and power density of energy flows) limit a given energy infrastructure's capacity for expansion and self-replication. The doubling time metric τ_2 measures the amount of time required for a given energy facility to produce and accumulate enough excess energy, after making a contribution to national energy demand, to replicate itself by constructing another facility of similar capacity—*i.e.*, it measures the capability of a given energy infrastructure to sustain and reproduce itself from its own output while making sufficient residual energy available for societal use. The doubling time metric for a given energy facility depends on several fundamental characteristics of its underlying technology, including: the capacity factor; amount of energy required for constructing and emplacing a unit of nameplate capacity; fraction of the facility's gross energy output used for its operation and maintenance; time required for constructing and emplacing a new facility; and effective lifetime of the facility.

Utilizing literature values of *EROI*, τ_1 , and other physical parameters based on life cycle analyses of different electric power generation sources, we find significant differences between fossil fuel fired plants, nuclear power, and renewable technologies in terms of their ability to achieve high rates of indigenous capacity expansion. The low power density of renewable energy extraction and the intermittency of renewable flows impose deep physical limits to their growth trajectory.

2. Historical Evolution of Energy Supply Infrastructures

At a simplified level of representation, an energy supply infrastructure consists of resource collection and concentration channels feeding into a conversion node that transforms the energy resource into more "convenient" energy carriers. These in turn supply distribution channels delivering energy to final users of energy services. The energy carriers have the capacity to deliver either heat or work. The converters transform a resource energy carrier into a delivery energy carrier that is more suitable to user needs. The resource delivery and the distribution channels involve spatial transport of energy carriers. In combination, they ship the energy content of the resource to the end user.

In general, each link in the energy supply chain produces wastes during the process of resource harvesting, transport, conversion and end use. The wastes range from solid to gaseous to heat. They may be chemically or radio toxic. They may be persistent or transitory.

Prior to the late 1700's the underlying energy resource was derived strictly from the sun. The radiant energy fluxes from the sun were collected and concentrated principally in three forms: (i) harvesting of foodstuffs which were carted to towns where they supplied animals and men who in turn were capable of delivering work; (ii) harvesting wood and straw and putting it into a processed form suitable for conversion into fire to heat and light; (iii) rain water concentrated onto streams and rivers running downhill where a waterwheel energy converter transformed it to work. Thus, the pre-industrial societies relied mainly on biomass fuels and animate energy converters [15]. This multi-millennium-old energy infrastructure prevailed in Europe and the Americas until the beginning of the 19th century and in most of Asia and Africa until the middle of the 20th century [16]. It still comprises the principal energy supply for a large segment of the world population today.

2.1. The Role of Energy Density and the Power Density of Energy Conversion

Table 1 compares the gravimetric energy density (amount of energy per unit of weight) of pre-industrial biomass fuels with the fossil resources of the industrial era and the nuclear fuel resource of the atomic era. Air-dry wood has energy density around 16 MJ/kg and most other biomass fuels have energy densities below 20 MJ/kg, while good quality bituminous coal is over 24 MJ/kg. The energy density of crude oil is just below 42 MJ/kg and that of refined oil products is 43-46 MJ/kg. Moreover, the energy density of uranium is over $3 \cdot 10^6$ MJ/kg. Solid and liquid fuels have an even greater advantage in terms of volumetric density (amount of energy per unit of volume) in comparison to biomass and gaseous fluids: natural gas rates around 35 MJ/m³ while crude oil has approximately 35 GJ/m³, *i.e.* its volumetric density is one thousand times higher [17-19].

Table 1. Energy densities of energy carriers.

Energy Carrier	Energy Density (MJ/kg)
Wood	16
Coal	22-25
Oil	42
Nuclear fuel	$3 \cdot 10^6$

The historic transitions from biomass to coal and then from coal to petroleum entailed a movement towards more concentrated sources of energy. Higher energy density carriers present significant advantages in terms of their extraction, portability, shipping and storage costs, and conversion options [17]. The greater the energy density (gravimetric and volumetric) the more energy transported or stored for the same amount of weight or volume. The changeover to a high energy density supply infrastructure took place not only at the resource harvest links in the supply chain but also at the conversion nodes and delivery links.

Table 2 compares the power densities (energy flux per unit of horizontal surface) of alternative electricity supply infrastructures. All renewable generation technologies have power densities that are substantially lower (2-3 orders of magnitude) than the fossil-fuelled modes. The modest energy density of renewable sources and the very low power density of renewable energy extraction imply that these new technologies will require much larger infrastructures, spread over significantly greater areas, relative to today's infrastructure of fossil fuel extraction, combustion and electricity generation, to produce an equivalent quantity of energy [17,20]. Renewable technologies will generally require larger energy expenditures for the initial emplacement of their facilities—*i.e.* they will entail higher emplacement energy costs per unit of nameplate capacity.

Table 2. Power densities of alternative electricity supply infrastructures.

Power Source	Power Density (W/m ²)	
	Low	High
Natural Gas	200	2000
Coal	100	1000
Solar (PV)Oil	4	9
Solar (CSP)	4	10
Wind	0.5	1.5
Biomass	0.5	0.6

2.2. Excess Energy Availability as a Driver of Social Change

Advances in most human endeavors—transportation, agriculture, commerce, science and technology, health care, household life—were driven directly or indirectly by the changes in society’s underlying energy systems and the availability of surplus energy. Indeed, the extraordinary expansion of the human population, economic growth and rising standards of living were powered by high-*EROI*, high energy surplus fossil fuels [2,20-21].

In the pre-industrial age, the attainable energy density at the output of a converter node was constrained by practical capacities of the harvest and shipping channels which supplied it. This in turn constrained the population density that could be supported. Food collection and delivery constrained the concentration of population to what its hinterland could support—primarily small villages embedded in the hinterland itself, to reduce delivery distances to a day’s travel or so. Waterwheels driving grain mills and sawmills of the 1800’s delivered very modest amounts of power. As a result, the cities of the preindustrial age were relatively small and societies were predominantly rural and agricultural [22].

Throughout the pre-industrial era, not only population densities, but overall populations were constrained by the infrastructure for food (energy) delivery. Malthus stated the constraint on a nation’s overall population as a function of arable land availability (*i.e.*, food/energy supply). Sustainability was maintained for many centuries preceding the late 1700’s as a quasi-steady state balance of energy supply and population – but it was maintained at a small world population and at a medieval lifestyle of stagnant (and small) GDP per capita [23].

The transition to high energy density carriers and converters, where it has taken place in the Western industrialized nations, has dramatically changed the character of society. Population is now concentrated in cities, many of which are huge compared to the pre-industrial era. Population migrated to the factory towns of England and America during the 1800’s to exploit the concentrated energy density from coal-fueled steam power. Factory production rapidly replaced the earlier cottage industry regime of societal organization.

There are several underlying causes for these historical changes in society that accompanied the evolution in energy supply infrastructure. They happened in part because the new energy supply infrastructure delivered an increased net surplus energy relative to that required to maintain the earlier medieval

steady state. Also, institutional arrangements were made which facilitated corresponding concentration of capital and labor to match the concentration of energy.

3. Transition Towards a Sustainable Global Energy Supply Infrastructure

In the 21st century, world society is attempting to achieve a transition to a new energy supply infrastructure that supports the tenets of sustainable development. The requirements of the enabling energy supply infrastructure include:

- Capacity to deliver net excess energy;
- Scalability;
- Longevity;
- Environmental friendliness;
- Capacity to achieve required growth rates.

The requirement for “generation of net excess energy” is the essential ingredient for the supply infrastructure to facilitate economic growth.

“Scalability” pertains to its practical capacity to supply the required vast amounts of energy to support rising global energy demand—the New Policies Scenario of the International Energy Agency (IEA) projects global energy consumption to increase by 36% from 2008 to 2035, rising from 12,300 Mtoe to 16,750 Mtoe [12].

“Longevity” pertains to the long term availability of the energy resource at current and projected levels of use into the distant future.

“Environmental friendliness” pertains to minimizing the waste burden generated by the infrastructure emplacement and operation and to reducing the carbon footprint.

“Capacity to achieve required growth rates” pertains to dynamic response capability of the infrastructure to grow under constraints of energy plowback required to support infrastructure growth and operation.

For the purposes of this paper, it is postulated that the energy carriers that deliver end use services will remain unchanged (electricity and liquid chemical fuels) because they are already optimized for high energy density, versatility and convenience. Rather, it is assumed that the transition to a sustainable energy supply infrastructure will occur in the resource harvesting and concentration and in the associated energy conversion nodes in the supply chain.

As evidence mounts on the threats of climate change, pressures are increasing for a major shift away from fossil fuels and towards renewable and other low-carbon energy sources. However, if history is of any guide, the transition to a low-carbon economy will be slower and more challenging than some optimists have claimed. Fossil fuels will be displaced but only gradually. In the New Policies Scenario of the IEA, for example, the share of fossil fuels in the primary energy mix will decline only modestly from 81% in 2008 to 74% in 2035 [12].

The impediments to a rapid energy transition derive from technological, economic, and social factors. First, technological innovations have to become available. Transitions require a specific sequence of

scientific advances, technical innovations, and organizational changes. If any one element of this sequence is missing or delayed, then the transition period becomes lengthier [24]. Second, since existing assets usually have long economic lifetimes, there is active resistance on the part of their owners to any change that would lead to their premature replacement. Finally, social reluctance to change and active resistance of stakeholders in the legacy infrastructure retard entry of new technologies. Significantly in that regard, market entry sometimes can result only because of changes in institutional arrangements (that are resisted by the stakeholders in the current regime).

Immutable physical upper bounds are imposed on the pace of entry by the energy balance of the proposed infrastructure itself. Energy must be expended to emplace and operate new infrastructure and this reduces the excess energy available for societal use. There are fears, for example, that a very rapid transition to a renewable-energy economy could lead to the cannibalization of energy from existing power plants and thus exacerbate the current global energy scarcity [25].

4. Figures of Merit for Energy Supply Infrastructures

Assume energy demand increases incrementally due to population growth and/or increase in annual energy use per capita. This demand increase will be accommodated by increasing the capacity of the supply infrastructure. When the number of deployed converter nodes, extent of area required to harvest the fuel resource, and the associated shipping needed for delivery to the converter are increased, then an incremental cost is incurred in the form of energy expended to emplace the new infrastructure and to operate it. This energy cost must be borne by the existing and new infrastructure. If this cost gets larger as a fraction of the capacity of the infrastructure to deliver energy, then the rate of delivery of net energy declines.

To assess the ability of alternative electricity generating technologies in facilitating the transition towards a sustainable global energy supply infrastructure we employ two existing figures of merit and propose a third one. Our analysis is guided by a simple and yet fundamental principle invoked by Hall et al [2]: that for any being or system to survive and grow, and thus make a contribution to sustainable development, it must gain substantially more energy than it uses in obtaining that energy. Moreover, as Cleveland [25] rightly notes, the size and rate of delivery of such surplus energy are important in assessing sustainability.

4.1. Energy Return in Energy Investment

Several figures of merit are in use to characterize the net (excess) energy output to be derived from emplacing or enlarging an energy supply infrastructure under an energy plowback constraint. One example is the energy return on (energy) investment (*EROI*). It is defined as [2, 26-28]:

$$EROI = \frac{\text{gross quantity of energy delivered over the infrastructure lifetime}}{\text{quantity of energy expended to emplace and operate the infrastructure over its lifetime}}$$

The numerator is given by:

$$(\text{Numerator}) = P_{np} \cdot \psi \cdot T$$

where

Sustainability **2011**, *3*

- P_{np} is the nameplate power capacity of the infrastructural facility;
- ψ is the facility's average load or capacity factor;
- T is the effective lifetime of the facility.

The denominator is equal to: the sum of the energy, E , expended to initially emplace (and ultimately decommission) the infrastructural facility, plus the energy expended for the operation and maintenance (O&M) of the facility over its lifetime:

$$(\text{Denominator}) = E + P_{np}\psi hT$$

where

- E is the energy expended to emplace and ultimately decommission the facility;
- h is the "hotel load fraction", *i.e.* the fraction of gross energy produced that is diverted for the operation and maintenance of the facility.

Thus,

$$EROI = \frac{P_{np}\psi T}{E + P_{np}\psi hT} \quad (1)$$

Note that in this definition:

- the energy content of the fuel resource harvested and processed is not included in the denominator – *i.e.*, only the energy needed for the infrastructure per se is accounted for;
- the conversion efficiency from fuel energy carrier to product energy carrier is embedded in the numerator – and the energy unit is joules of heat for both numerator and denominator.

Inspection of the formula shows that $EROI$ will be increased by:

- reducing $\frac{E}{P_{np}}$, the emplacement energy/nameplate capacity;
- increasing ψ , the load factor;
- reducing h , the O&M energy fraction of production;
- increasing T , the facility's lifetime.

When determining the numerical value of $EROI$ for an energy supply infrastructure, it is necessary to consider the entire supply chain from harvesting the resource to delivering energy services to end users – summing up all the energy expended to emplace and operate that supply chain. This involves a life cycle analysis (LCA) to evaluate energy consumption elements in every stage of the supply chain—the resource collection, energy conversion, and the energy distribution and delivery links of the infrastructure.

The extent of upstream and downstream energy expenditures to emplace new infrastructure is not standardized, and as a result, ranges of values for *EROI* are found in the literature. LCAs are extensive undertakings when performed individually for a specific infrastructure, and are even more complex when done to enable a comparison of alternative infrastructures under consistent assumptions. Still, there are several comparative LCAs in the literature that have taken care to report values for *EROI* under consistent assumptions for alternative candidate infrastructures.

Given an *EROI* value for a candidate infrastructure, the excess energy available for societal use is [3,29]

$$\begin{aligned} \text{(Lifetime Excess Energy)} &= \text{(Lifetime Gross Energy Output)} - \text{(Lifetime Energy Input)} \\ &= \text{(Lifetime Gross Energy Output)} \cdot \left[1 - \frac{1}{\text{EROI}} \right]. \end{aligned}$$

As Hall [30] points out, while much of human progress can be attributed to technology, much of that technology has been a means for using more energy for human ends. Surplus energy is what facilitates economic growth, technological progress, and most human endeavors. If energy supply infrastructures with high *EROI* are deployed then only a small portion of society's energy budget would be required by the energy sector itself. The rest could be utilized to support all economic, commercial, and social activities that are so critically dependent upon energy [20].

The *EROI* as a figure of merit pertains to "efficiency" of an infrastructure—its ability to deliver excess energy to society—integrated over its lifetime (given an assumption about the availability of a resource input). However, it does not address:

- scalability (because it is a ratio);
- longevity (because it assumes the availability of a resource);
- capacity to achieve required growth rates.

An informative way to think about *EROI* is in terms of the fraction of lifetime gross energy output that is expended for initial emplacement and that which is needed for operation and maintenance:

$$\text{EROI} = \frac{P_{np}\psi T}{E + P_{np}\psi hT} = \frac{1}{\frac{E}{P_{np}\psi T} + h} \quad (2)$$

i.e.,

$$\text{EROI} = \frac{1}{\left(\begin{array}{c} \text{fraction of gross production} \\ \text{expended for initial emplacement} \end{array} \right) + \left(\begin{array}{c} \text{fraction of gross production} \\ \text{expended for O\&M} \end{array} \right)}$$

The first term represents an initial "capitalization" expenditure of energy. And the second term represents an ongoing "variable" expenditure. However, unless the details of the LCA are available, this breakdown is not evident because when *EROI* values are reported, the two components of the denominator become subsumed and indistinguishable within a single number.

4.2. Energy Payback Period

A second figure of merit, the “energy payback period”, τ_1 , is used to characterize the “capital” component. The energy payback period is a measure of the time interval required for the infrastructure – once it is installed – to deliver net energy sufficient to cover the initial energy investment [31,32]

$$\tau_1 P_{np} \psi (1 - h) = E \quad (3)$$

or

$$\tau_1 = \frac{E}{P_{np} \psi (1 - h)} \quad (4)$$

Writing

$$\frac{\tau_1}{T} = \frac{E}{P_{np} \psi (1 - h) T} \quad (5)$$

it can be seen that the ratio of energy payback period to infrastructure lifetime, τ_1/T , will be much less than 1.0 (which is obviously desirable) if:

- $\frac{E}{P_{np}}$ the energy expended for emplacing a unit of nameplate capacity is small;
- ψ the capacity factor is large;
- h the portion of gross production going to O&M is much less than 1;
- T the infrastructure’s effective lifetime is long.

If the detailed reporting of a LCA includes values for both $EROI$ and τ_1 , then it is possible to “back calculate” the two subcomponents of $EROI$.

4.3. Doubling Time

The doubling time metric, τ_2 , is a measure of the time interval required to accumulate enough excess energy to deploy new infrastructure sufficient to double power output. It is necessary to develop equations for the infrastructure’s dynamic response in order to find a mathematical expression for the doubling time figure of merit [33].

Consider the growth of an energy park where at time t :

$$\begin{aligned} P(t) &= \text{power available for societal use} \\ P_{np}(t) &= \text{installed nameplate power capacity} \end{aligned}$$

The annual-average power available for societal use is related to installed nameplate power as:

$$P(t) = P_{np}(t)\psi(1-h)(1-\beta) \quad (6)$$

where β is the fraction of produced power that is plowed back into the construction of new plants and their associated resource supply and delivery infrastructures.

Based on the availability of energy diverted from societal use to build new infrastructure, the incremental capacity $dC(t)$ under construction during time period dt is:

$$dC(t) = C(t + dt) - C(t) = dt \left[\frac{(1-h)\psi\beta P_{np}(t)}{q} - \frac{C(t)}{\lambda} \right] \quad (7)$$

where:

- $C(t)$ = nameplate plant capacity under construction at time t ;
- $q = \frac{E}{P_{np}}$ is the energy expended to construct a unit of nameplate power capacity and its supporting infrastructure;
- λ = average facility licensing and construction time.

The net capacity of nameplate power coming on line during time interval dt is the net of new build and decommissioning:

$$dP_{np}(t) = P_{np}(t + dt) - P_{np}(t) = dt \left[-\frac{1}{T}P_{np}(t) + \frac{C(t)}{\lambda} \right] \quad (8)$$

Collecting the above results, the system equations that define the dynamics of growth for the energy supply under an energy plowback constraint are:

$$\begin{aligned} \frac{d}{dt}P_{np}(t) &= -\frac{1}{T}P_{np}(t) + \frac{C(t)}{\lambda} \\ \frac{d}{dt}C(t) &= \frac{(1-h)\psi\beta P_{np}(t)}{q} - \frac{C(t)}{\lambda} \end{aligned} \quad (9)$$

or in matrix notation

$$\frac{d}{dt} \begin{Bmatrix} P_{np}(t) \\ C(t) \end{Bmatrix} = \mathbf{A} \begin{Bmatrix} P_{np}(t) \\ C(t) \end{Bmatrix} \quad (10)$$

where

$$\mathbf{A} = \begin{Bmatrix} -\frac{1}{T} & \frac{1}{\lambda} \\ \frac{(1-h)\psi\beta}{q} & -\frac{1}{\lambda} \end{Bmatrix} \quad (11)$$

The initial boundary conditions (assuming steady state) are

$$P_{np}(t_0) = P_0 \quad (12)$$

$$C(t_0) = \lambda \frac{(1-h)\psi\beta}{q} P_0.$$

The most positive eigenvalue of the state transition matrix, \mathbf{A} , sets the upper bound on the rate of energy supply growth attainable for a given reinvestment factor, β . The eigenvalues, α , of \mathbf{A} are solutions of the quadratic equation:

$$\det |\mathbf{A} - \alpha \mathbf{I}| = 0 \quad (13)$$

$$\det \begin{vmatrix} -\frac{1}{T} - \alpha & \frac{1}{\lambda} \\ \frac{(1-h)\psi\beta}{q} & -\frac{1}{\lambda} - \alpha \end{vmatrix} = 0$$

or

$$\alpha^2 + \alpha\left(\frac{1}{\lambda} + \frac{1}{T}\right) + \frac{1}{\lambda T} - \frac{1}{\lambda} \frac{(1-h)\psi\beta}{q} = 0 \quad (14)$$

This equation can be solved for the eigenvalues, α , using the quadratic formula:

$$\alpha = \frac{-\left(\frac{1}{\lambda} + \frac{1}{T}\right) \pm \sqrt{\left(\frac{1}{\lambda} + \frac{1}{T}\right)^2 + \frac{4}{\lambda T} \left[\frac{(1-h)\psi T\beta}{q} - 1\right]}}{2} \quad (15)$$

There are two eigenvalues. By inspection, at least one is positive if $\frac{(1-h)\psi T\beta}{q} > 1$. Calling the most positive eigenvalue α^* , the persisting solution of the state equations is simple exponential growth at an annual rate of α^* , starting from the steady state initial condition:

$$P_{np}(t) = P_0 e^{\alpha^* t} \quad (16)$$

$$C(t) = \lambda \frac{(1-h)\psi\beta}{q} P_0 e^{\alpha^* t}$$

The doubling time figure of merit τ_2 – applicable to growing infrastructures under an energy plowback constrained is defined as

$$\tau_2 = \frac{\ln 2}{\alpha^*} \quad (17)$$

and is the time interval it takes to accumulate the energy needed to double the emplaced infrastructure—given a specified energy reinvestment fraction, β .

The upper bound on achievable growth rates, α^* , constrained by energy plowback, is determined by the following infrastructural characteristics:

- λ : licensing and construction time period;
- T : asset lifetime;
- ψ : capacity factor;
- β : energy plowback fraction;
- h : O&M plowback fraction;
- q : amount of energy expended to emplace a unit of nameplate capacity.

The sources for numerical values for these parameters are as follows: T , ψ , h , and q are usually documented in the life cycle analyses that produce values for $EROI$ and/or τ_1 ; licensing and construction time period, λ , is known from actual plant construction practice; and the energy plowback fraction, β , is a parameter to be assumed in parametric scoping studies.

5. The Structure of Net Excess Energy and the Growth Potential of Alternative Infrastructures

We have noted above the essential role of surplus energy availability ($EROI \gg 1$) in enabling economic growth and the historical evolution toward higher energy density carriers and higher power density converters as an effective way to increase the value of $EROI$.

The current energy infrastructure of industrial and many developing countries is based on fossil resources. This infrastructure does not meet the tenet of sustainable development. But it is not enough merely to restructure it at its current overall level because energy demand will be growing in the 21st century in response to increasing per capita energy use and increasing world population.

After improvements in efficiency of energy use and conversion are exhausted, growth in energy supply will necessitate emplacement of additional energy infrastructure assets. These emplacements will consume energy. Indeed, to support energy infrastructure expansion, it will be necessary for some fraction of the energy from both legacy and newly emplaced assets to be diverted from societal use and reinvested in order to support the next increment of capacity expansion.

This section will examine the dynamics of growth of energy supply under the constraint of energy plowback for incremental infrastructure emplacement. Using the idealized model developed above, it is possible to: (i) identify the essential constraints on feasible rates of growth; and (ii) clarify why the single numerical values of the $EROI$ are not by themselves sufficient for assessing the growth potential of alternative energy infrastructures—*i.e.* that it is important to analyze and understand the structure and time dependencies of the energy investments that are required for emplacing and maintaining these infrastructures.

5.1. The Importance of Up-Front (Emplacement) Energy Investment and Load Factor

To meet rapid growth in energy demand a high value of α^* (a short doubling time) is desirable. Examination of (14) indicates that the infrastructure's indigenous growth α^* will be larger when

$$\frac{(1-h)\psi T\beta}{q} > 1 \text{ and } \lambda T < 1 \quad (18)$$

With the exception of the energy plowback fraction, β , all the other parameters determining the above inequalities reflect the infrastructure's underlying physical and technological characteristics. Substantial differences between fossil fuel-based and renewable infrastructures in terms of these underlying characteristics have very significant implications for their differential ability to sustain high rates of indigenous growth.

One of the most fundamental attributes of renewable technologies is intermittency, which refers to the fraction of time that a given energy source/facility is available to society [20]. An important consequence of the intermittency of these technologies (*i.e.*, the fact that wind does not blow all the time and the sun does not shine all the time) is their low capacity or load factor—*i.e.*, low ψ values. By contrast, because of the continuous nature of fossil fuel extraction, most conventional (fossil-fueled and nuclear) generating technologies have very high load factors (high ψ values) and are “dispatchable.”

Fossil-fueled and renewable technologies also have substantially different energy and power densities. The lower energy density of renewable sources as compared to fossil fuels implies that the former require significantly larger infrastructures—labor, capital, materials and energy—to produce an equivalent amount of energy [20]. Similarly, the low power density of renewable energy extraction implies that for renewable infrastructures large quantities of energy must be expended to emplace a unit of nameplate power capacity—*i.e.*, for renewable conversion nodes, q is large.

The fact that renewable technologies have low ψ and high q values while fossil-fueled generating modes have high ψ and low q values (and hence the ratio $\frac{\psi}{q}$ has much larger values for fossil-fueled as compared to renewable technologies), has important consequences for their respective abilities to achieve high rates of indigenous growth. What matters to doubling time is the time phasing of the initial capital vs the ongoing O&M components of $EROI$. Consider the case of a renewable technology whose $EROI$ is similar to that of a fossil-fueled generation mode. Given a value for $EROI$, it is easy to see from (3) that

$$\frac{(1-h)\psi T\beta}{q} = \left\{ \frac{\psi T}{q} \left[1 - \frac{1}{EROI} \right] + 1 \right\} \beta \quad (19)$$

Even with the same value of $EROI$, the renewable technology could still have a much smaller value $\frac{\psi}{q}$ (relative to the fossil fueled technology) because of its intermittency and low power density. Assuming that the two technologies have similar T values (and the energy plowback fraction β is the same), then (18) implies that the value of $\frac{(1-h)\psi T\beta}{q}$ for the renewable technology will be much smaller relative to that of the fossil fueled technology. This in turn implies, according to (14), that the renewable

technology will have a much lower achievable growth rate, α^* (and correspondingly longer doubling time τ_2) relative to the fossil fueled generating mode.

5.2. Illustrative Example: Growth Potential under an Energy Plowback Constraint

IEA [34] performs a life cycle analysis (LCA) of different electricity generation sources (coal, oil, LNG, nuclear, wind, PV, solar thermal, hydro, and geothermal) in Japan. And it applies a consistent set of net energy formulas across the different generation options. The study's analysis is based on power outputs and annual capacity factors for the most typical generation plants in Japan—for fossil fuels and nuclear the reported values for annual capacity take into account periodic inspections while for renewables they are the maximum obtained under normal operating conditions in Japan. The estimates of the net supplied energy by each power generation system are based on a standardized power plant with nameplate capacity of 1,000 MW and an assumed life expectancy of 30 years for each plant. From the net supplied energy data, the energy payback period of each generation option is being estimated.

The IEA study was published in 2002. Thus, the study's reported estimates of LCA parameters are considerably outdated—especially for wind which has been experiencing very rapid technical change. Moreover, capacity factors and consequently net energy returns for renewables are highly site-dependent. Clearly, the wind and solar resources of Japan are not necessarily comparable to those found in the best sites around the world. However, the objective of our illustrative analysis is not to obtain the most accurate point estimates or representative values of net energy parameters. Instead, what we seek to show is that the single numerical values of $EROI$ are not by themselves sufficient to evaluate the potential of alternative energy supply infrastructures for indigenous growth.

The study provides estimates of $EROI$, ψ , τ_1 and assumes that $T = 30$. For both coal-fired generation and wind power, $EROI = 6$. Coal has a much larger capacity factor ($\psi = .75$) relative to wind ($\psi = .20$). Moreover, coal has a much shorter estimated energy payback period ($\tau_1 = 0.15$ years) in comparison to wind ($\tau_1 = 3.39$ years). From these values we can back-calculate $\frac{E}{P_{np}\psi T}$, q , and h .

These estimates are presented in Table 3. For coal, $q = .094$ and thus $\frac{\psi}{q} = 7.98$. For wind, $q = .637$ and $\frac{\psi}{q} = 0.31$. With a 20% plowback (*i.e.* $\beta = .2$), coal-fired plants can attain 73% annual expansion growth rate while for wind power the computed annual growth rate is only 2%.

Thus, coal-fired generation shows potential to support rapid indigenous growth. Wind, on the other hand, seems quite constrained. This at first might appear to be surprising in light of wind's $EROI$ being as large as coal's and its O&M plowback fraction h being smaller than that of coal. To understand this outcome it is necessary to recognize the time phasing of the initial capital energy input vs the ongoing O&M energy inputs making up $EROI$ in (3). The initial capital component for wind, representing the fraction of gross production expended for initial emplacement, is over 25 times larger than that of coal's—or equivalently for coal the ratio $\frac{\psi}{q}$ is over 25 times larger than that of wind's. According to (18), this implies that the ratio $\frac{(1-h)\psi T\beta}{q}$ has a much larger value of 40.08 for coal relative to wind for which the corresponding value is just 1.75. The doubling time τ_2 , again with a 20% plowback, is 1.3

years for coal and 28.5 years for wind. Thus, the ability of wind to rapidly scale up its production by bootstrapping its own energy appears to be limited relative to coal.

Table 3. Breakout of components of EROI and growth potential under energy plowback constraint.

	$EROI$	T	ψ	τ_1	$\frac{E}{\psi P_{np} T}$	h	$q = \frac{E}{P_{np}}$	λ	β	α^*	τ_2
Coal	6	30	0.75	0.15	0.004	0.163	0.094	4	0.2	0.55	1.3
Wind	6	30	0.20	3.39	0.106	0.061	0.637	1	0.2	0.02	28.5

6. Summary and Conclusions

Among the desirable features of an energy supply infrastructure are the ability to deliver large amounts of surplus energy and to grow at the rate required by societal need. The latter is becoming increasingly important in view of the expected substantial growth in global energy demand (mainly from developing countries) and the urgency to stabilize greenhouse gas emissions by transitioning as rapidly as possible to low-carbon energy systems. The two most frequently quantified metrics of net energy analysis, the energy return on (energy) investment and the energy payback period, do not capture the growth rate potential of an energy supply infrastructure. This is because in the analysis underlying these metrics, all energy inputs and outputs are treated the same, regardless of where they occur in the life cycle of a given infrastructure.

We develop a dynamic energy analysis framework to model the growth potential of alternative electricity supply infrastructures. A key feature of our model is the requirement that part of the energy output from a given infrastructure is reinvested for capacity expansion (*i.e.*, the construction of new plants) while the rest is made available to meet society's demand for energy. An additional figure of merit, the infrastructure doubling time, is introduced. This metric highlights the critical importance of the time phasing of the initial energy investment for emplacing a given infrastructure, as opposed to the ongoing O&M energy expenditures, for the infrastructure's growth potential. The doubling time metric also captures the influence of capacity factor, licensing and construction time lags.

The efficacy of the doubling time metric is illustrated by comparing the growth rate potential of fossil (coal) versus renewables (wind) technologies with similar EROIs and using the same energy plowback (reinvestment) fraction for each. The illustration shows that the lower capacity factor and front-loaded capital versus operating energy requirements of wind slow down its achievable growth rate, compared to that of coal.

When the growth rate for a specific supply option is specified by societal need or by policy, the necessary energy input for growth of the chosen supply option will be diverted from societal usage – either by increasing its indigenous energy plowback fraction or by subsidizing its energy requirement from another supply option. While an EROI value well in excess of unity is necessary for self-supplied infrastructure growth, it is not sufficient; capacity factor and energy necessary for emplacement and for operation and time lags for licensing and construction also play an important role.

This paper focusses on the growth potential of alternative electricity supply infrastructures as constrained by innate physical energy balance and dynamic response limits. It seeks to provide a deeper understanding of the powerful physical limits that are facing the alternative generating technologies—physical limits and constraints that cannot be relaxed through economic policy measures. However, the paper’s emphasis on the technical headroom of alternative generating technologies does not seek to supplant the time-honored economic cost-benefit analysis. Nor does it question the power of the incentives provided by market pricing mechanisms for the efficient allocation of scarce energy resources. Instead, it seeks to facilitate a technical reality check on the potential of these technologies to have an impact on the scale required by the global energy problem. It can also furnish more accurate and timely signals of impending critical conditions [35]. Especially in the presence of significant market imperfections and externalities, the paper’s net energy methodology could serve as an important complement to economic analysis for evaluating prospective energy supply architectures.

References

1. Hall, C.A.S.; Powers, R.; Schoenberg, W. In peak oil, EROI, investments and the economy in an uncertain future. In *Renewable Energy Systems: Environmental and Energetic Issues*; Pimentel, D., Ed.; Elsevier: London, UK, 2008.
2. Hall, C.A.S.; Balogh, S.; Murphy, D.J. What is the minimum EROI that a sustainable society must have? *Energies* **2009**, *2*, 25-47.
3. Murphy, D.J.; Hall, C.A.S. Year in review—EROI or energy return on (energy) invested. *Ann. N. Y. Acad. Sci.* **2010**, *1185*, 102-118.
4. Kubiszewski, I.; Cleveland, C.; Endres, P. Meta-analysis of net energy return for wind power systems. *Renewable Energy* **2010**, *35*, 218-225.
5. Bankier, C.; Gale, S. Energy payback of roof mounted photovoltaic cells. *The Env. Eng.* **2006**, *7*, 11-14.
6. Fthenakis, V.; Alsema, E. Photovoltaics energy payback times, greenhouse gas emissions and external costs: 2004-early 2005 status. *Prog. in Photov. : Res. and Appl.* **2006**, *14*, 275-280.
7. Fthenakis, V.; Kim, V.; Alsema, E. Emissions from photovoltaic life cycles. *Environ. Sci. Technol.* **2008**, *42*, 2168-2174.
8. Murphy, D.J.; Hall, C.A.S.; Powers, R. New perspectives on the energy return on (energy) investment (EROI) of corn ethanol. *Environ. Dev. Sustain.* **2011**, *13*, 179-202.
9. Jacobson, M.Z.; Delucchi, M.A. Providing all global energy with wind, water, and solar power, part I: technologies, energy resources, quantities and areas of infrastructure, and materials. *Energy Policy* **2011**, in press.
10. Jacobson, M.Z.; Delucchi, M.A. Providing all global energy with wind, water, and solar power, part II: reliability, system and transmission costs, and policies. *Energy Policy* **2011**, in press.
11. MacKay, D. *Sustainable Energy—Without the Hot Air*; Cambridge University Press: Cambridge, UK, 2008.
12. IEA (International Energy Agency). *World Energy Outlook 2010*; OECD/IEA: Paris, France, 2010.

13. Hagens, N. Applying time to energy analysis. *The Oil Drum* 2010. Available online: <http://www.energybulletin.net/stories/2010-12-13/applying-time-energy-analysis> (accessed on 4 December 2011).
14. Mathur, J.; Bansal, N.K.; Wagner, H-J. Dynamic energy analysis to assess maximum growth rates in developing power generation capacity: case study of India. *Energy Policy* 2004, 32, 281-287.
15. Cleveland, C. Energy quality, net energy, and the coming energy transition. In *Proceedings of Sixth Annual Energy Conference on the Future of Oil as an Energy Source*, Abu Dhabi, United Arab Emirates, 7–8 October 2000.
16. Smil, V. Moore's curse and the great energy delusion. *The American*, November 19, 2008.
17. Smil, V. Power density primer, parts i-v. *Master Resource*, 2010, <http://www.vaclavsmil.com/wp-content/uploads/docs/smil-article-power-density-primer.pdf>.
18. Maciejewska, A.; Veringa, H.; Sanders, J.; Peteves, S.D. Co-Firing of Biomass with Coal: Constraints and Role of Biomass Pre-treatment. DG JRC Institute for Energy, 2006.
19. What is nuclear? <http://www.whatisnuclear.com/articles/nucenergy.html> (accessed on 4 December 2011).
20. Cleveland, C. Energy Transitions Past and Future. *Encyclopedia of Earth*, 2008.
21. Hall, C.A.S.; Klitgaard, K. *Energy and the wealth of nations: understanding the biophysical economy*; Springer: New York, USA, forthcoming.
22. Munro, J.H. Industrial energy from water-mills in the European economy, 5th to 18th centuries: the limitations of power. MPRA Paper No. 11027, 2002. Available online: <http://mpra.ub.uni-muenchen.de/11027/> (accessed on 4 December 2011).
23. Braudel, F. *Civilization and Capitalism 15th–18th Century: Vol I The Structure of Everyday Life*; University of California Press: Berkeley, CA, USA, 1992.
24. Smil, V. *Energy Transitions: History, Requirements, Prospects*; Praeger: Oxford, UK, 2010.
25. Pearce, J. Optimizing greenhouse gas mitigation strategies to suppress energy cannibalism. 2nd Climate Change Technology Conference, Hamilton, Ontario, Canada, 12–15 May 2009.
26. Cleveland, C. Ten fundamental principles of net energy. In *The Encyclopedia of Earth*, 2008; Available online: http://www.eoearth.org/article/Ten_fundamental_principles_of_net_energy (accessed on 1 September 2011).
27. Hall, C.A.S.; Cleveland, C.; Kaufmann, R. *Energy and Resource Quality: The Ecology of the Economic Process*; Wiley Interscience: New York, USA, 1986.
28. Hall, C.A.S.; Cleveland, C. EROI: definition, history and future implications. Presented at ASPO-US Conference, Denver, 10 November 2005.
29. Mulder, K.; Hagens, N. Energy return on investment: towards a consistent framework. *Ambio*, 2008, 39, 74-79.
30. Hall, C.A.S. Provisional results from EROI assessments. *The Oil Drum*, 2008. Available online: <http://www.theoil Drum.com/node/3810> (accessed on 4 December 2011).
31. Gagnon, L. Civilisation and energy payback. *Energy Policy* 2008, 36, 3317-3322.
32. Knapp, K.; Jester, T. Empirical investigation of the energy payback time for photovoltaic modules. *Solar Energy* 2001, 71, 165-172.

33. Utamura, M. Analytical model of carbon dioxide emission with energy payback effect. *Energy* **2005**, *30*, 2073-2088.
34. IEA (International Energy Agency). Environmental and Health Impacts of Electricity Generation; The International Energy Agency–Implementing Agreement for Hydropower Technologies and Programmes, 2002. Available online: <http://www.ieahydro.org/reports/ST3-020613b.pdf> (accessed on 4 December 2011).
35. Berndt, E. From technocracy to net energy analysis: engineers, economists and recurring energy theories of value. MIT WP#1353-82, 1982.

© 2011 by the authors; licensee MDPI, Basel, Switzerland. This article is an open access article distributed under the terms and conditions of the Creative Commons Attribution license (<http://creativecommons.org/licenses/by/3.0/>).

Article

Looking for a Silver Lining: The Possible Positives of Declining Energy Return on Investment (EROI)

Jack P. Manno

SUNY College of Environmental Science and Forestry, Syracuse, NY 13210, USA;

E-Mail: jpmanno@esf.edu; Tel.: +1-315-470-6816; Fax: +1-315-470-6915

Received: 3 February 2011; in revised form: 28 April 2011 / Accepted: 13 June 2011 /

Published: 26 October 2011

Abstract: Declining energy return on investment (EROI) of a society's available energy sources can lead to both crisis and opportunity for positive social change. The implications of declining EROI for human wellbeing are complex and open to interpretation. There are many reasons why frugal living and an energy diet could be beneficial. A measure of wellbeing or welfare gained per unit of energy expended (WROEI) is proposed. A threshold is hypothesized for the relation between energy consumption and wellbeing. The paper offers a biophysical-based social science explanation for both the negative and positive possible implications of declining EROI. Two sets of future scenarios based on environmental and economic trends are described. Six types of social change activism are considered essential if the positives of declining EROI are to balance or exceed the negatives.

Keywords: energy; EROI; human wellbeing; thresholds; degrowth; scenarios; social change

1. The Implications of Declining EROI for Human Wellbeing

Energy Return on Energy Invested (EROI) represents a simple ratio; the amount of energy obtained from any energy-producing activity divided by the energy used to make that amount of energy available for productive activities. EROI is a ratio while a related term, Net Energy, refers to the remainder from subtracting energy *input* from energy *output*. Total Net Energy represents the “productive energy”, the energy available for all the economic, social, cultural and other activities of daily life. Fossil fuels represent dense concentrations of energy available to apply to modern industry and convenience. These qualities are captured mathematically in higher EROI values for fossil fuels compared to other energy sources. The EROI of most alternatives do not come close to producing the

net energy of fossil fuels. As reported in Hall *et al.* [1] and in various papers in this special issue, the recent precipitous decline in EROI for oil and gas, by far the most important energy source of modern industrial economies, suggests that we have utilized (or squandered) what may well be a one-time gift that has powered economic growth since the Industrial Revolution.

Society must make difficult energy choices that have serious consequences for the environment and future generations and they must be made increasingly under conditions constrained by declining EROI, the related phenomenon of Peak Oil and accompanying upward pressures on energy prices. In my opinion, EROI and Net Energy analysis should be considered essential data for informing political and economic choices among alternative energy investments and policies but so far this has rarely been done. It is equally important to understand the many ambiguous and negative consequences of a hyperactive economy driven by cheap energy.

The decline in EROI and Net Energy of fossil fuels results from the fact that most of the readily available high quality reservoirs are already in production. Newer discoveries tend to be in deep water, in remote and hostile surroundings, at great depths, bound in shale or sand or otherwise in conditions requiring considerably more energy to bring to market than has been the norm in the petroleum age. In addition to the increasing energy needed to obtain new oil, EROI also declines when the quality of available fuels is poorer and therefore burns with less intensity. Declining EROI of a nation's energy sources must necessarily lead to reductions in that portion of national income available for discretionary consumption and investment. More energy has to be used simply to obtain energy and therefore less is available for everything else a nation produces or invests in. This will have social consequences. The negative consequences are foreseeable as economic decline of various sorts. Some of the consequences of reduced energy availability, however, might be positive. The reason for this is the focus of this paper.

The implications of declining EROI for human wellbeing are complex and open to interpretation. The most obvious implication is that discretionary spending is likely to decline substantially as more and more of society's output is required to maintain necessary inputs. Economic growth may stall and stagnation could settle in. But considering that a significant but not readily quantified portion of the energy consumed in modern industrial societies powers activities that are destructive to human wellbeing and the environment, choices made to reduce them could benefit everyone. There are many reasons why frugal living and an energy diet could be beneficial. A shift of emphasis towards increasing the amount wellbeing or welfare derived per unit of energy used or invested (Welfare Returned on Energy Invested, or WROI) would make it possible to imagine and plan for a *prosperous way down* [2] or what the European advocates of *décroissance* [3] have defined as “an equitable downscaling of production and consumption that increases human well-being and enhances ecological conditions at the local and global level, in the short and long term.” [4]. It also is in agreement with the nascent movement in the U.S. for a “Steady State economy” [5,6].

2. A Threshold Hypothesis for the Relation Between Energy Consumption and Human Wellbeing

In one of the early issues of the journal, *Ecological Economics*, the Chilean economist Manfred Max-Neef [7] offered a threshold hypothesis. He argued that “For every society there seems to be a period in which economic growth (as conventionally measured) brings about an improvement in the quality of life, but only up to a point—the threshold point—beyond which, if there is more economic

growth, quality of life may begin to deteriorate". Niccolucci *et al.* [8] reviewed data on Index of Sustainable Economic Welfare (ISEW) and Genuine Progress Indicator (GPI), two indicators commonly offered as alternatives to GDP as a measure a nation's progress. Analyzing the relation between GDP and a nation's Ecological Footprint the authors concluded that, "increase in economic wealth often results in worse, not better, conditions for people because the welfare related to a given GDP is 'polluted' and diminished by environmental stress and social pressures". This is consistent with Herman Daly's [5] concept of "uneconomic growth" defined as occurring when "increases in production come at an expense in resources and well-being that is worth more than the items made." Given the tight correlation and logical link between economic growth and total energy use, a similar inverted U curve holds for the relation between increased energy use and a number of measures of wellbeing. The United Nations Development Program estimates that it requires one Ton of Oil Equivalent (TOE)/per capita to reach a fairly high state of national health and development. Energy consumption beyond that buys little additional benefit [9]. Energy analyst Vaclav Smil [10] has estimated that consumption of 1.194–1.672 TOE of commercial energy per person is enough to meet essential physical needs plus high quality education and social services. On average, in 2005 the world's population consumed 1.778 TOE/capita annually [11]. The world's energy glutton, Qatar consumed over 19,000 TOE/capita while in the United States and Canada annual consumption hovers around 8,000 TOE/capita. In general, as annual per capita energy use increases, measures of quality of life increase in step, up to a point after which increases in quality of life are no longer evident. As Smil concluded, "Higher energy use does not guarantee anything except greater environmental burdens" (p. 386). Measures of WROEI would likely demonstrate a significant decline at the margins beyond the modest levels of energy consumption associated with frugal and energy efficient lifestyles.

Similarly, self-reported levels of happiness among the poor tend to rise with increased income while levels of emotional depression decline. The relation between self-reported state of happiness and personal income, however, largely disappears beyond moderate levels of income [12]. Up to a point, one can buy at least a chance at happiness but that point may be well below what is taken for granted in affluent societies. None of this is surprising. Too much energy introduced into a system can overwhelm it. For analogy consider the problem of eutrophication of a lake or pond. An overabundance of fertilizing nutrients entering the water stimulates the growth of plankton and thus excessive photosynthesis and a decline in oxygen that leads to rapidly degrading conditions for most fish. The shore becomes awash in rotting algae and dead fish. Think Lake Erie in the 1970s. Consider also how a starving person rapidly improves by increasing caloric intake. However, the average North American who presently takes in 3,600 calories a day (world average is 2,700 calories) is not well served by adding another pound of steak to his daily diet. Consider the energy that goes into producing, processing, storing, transporting and preparing the average American meat-eating diet emits 8,800 pounds of CO₂ per day, just less than the average US car [13]. The WROEI beyond these points turns rapidly negative.

Many of the means we have to reduce energy use are also steps toward improving one's health. Walk, ride bikes, drive less. Eat more fruits and vegetables, preferably organic and locally grown. The WorldWatch Institute in its State of the World report [14] points out how our isolated, lonely lives expand our energy consumption: "A one person household in the United States uses 17% more energy per person than a two person household". Friendship and sharing meals, tools, conversation,

skill-sharing and other community-building activities go a long way toward reducing our dependence on individual consumption to achieve satisfaction and maintain health, while significantly reducing ecological footprints.

The positive consequences of declining EROI may be less obvious than the negatives but when one looks at the range of inverted U relations between energy consumption and human wellbeing the notion begins to dawn that society should be guided by the concept of an optimal level of energy consumption rather than by the push to maximize economic activity and thus energy. It is completely possible and to some, obvious that wealthy industrial societies have exceeded a sustainable optimum, in particular those nations that can be considered energy gluttons. For those societies on the upward slope of the energy and wellbeing U curve, more available energy should lead to more social and individual wellbeing, increasing WROEI. For modern industrial societies that appear to be on the downward slope where marginal cost of energy use exceeds marginal benefit, declining WROEI, an energy diet would be beneficial. Like most addicts people in modern industrial societies are unlikely to voluntarily choose to live less energy intense lifestyles, despite the best persuasive efforts to encourage simpler living. But facing less availability and higher prices associated with declining EROI, less energy is what we will have.

3. Towards a Biophysical-Based Social Science Understanding of the Inverted U Relation Between Energy and Wellbeing

Declining EROI will likely lead to social change. To understand the nature of this change, consider how in biophysical terms, a society can be thought of as consisting of networks of flows of materials and networks of flows of energy. Through these flows and the products in which these flows are embodied we meet our basic needs for food, clothing, shelter, transportation and warmth as well as all our luxuries and conveniences [15]. People make daily livelihood and lifestyle decisions, consciously and not, based on their notion of how to connect to these flows in order to support themselves, their families and communities. These flows add up to society's metabolism and the combination of these flows and the decisions people make to connect themselves with these flows becomes the self-organizing entity we call an economy.

As society experiences change, whether through new technology, new ideas, changes in financial circumstances, or changes in energy quality and availability; individuals must realign themselves in relation to the altered networks of energy and material flows. Some individuals experience the accompanying changes as threats, others as opportunities, many as both.

The networks of energy and material flows involve transactions at various points of connectedness. Most, if not all, of these connections are through interactions with markets, communities or ecosystems. As citizens, neighbors, family members, and friends we are connected to families and communities; as consumers, producers workers, buyers and sellers we are connected to markets; and as physical beings, mammals, we are connected to land, air, water, sunlight, ecosystems. Obviously these nodes of connectedness, or roles, do not exhaust what it means to be human and they overlap in the life experience of any individual; but they largely structure our relation to energy. Through these connections, people also find much of our meaning and belonging. Throughout history, societies have differed in the degree to which one or the other mode of connectedness has dominated, in other words, through which networks most of the throughput has traveled. In hunter-gatherer societies, energy

and material flows were mediated through earth-based and small community-based connectedness. As Hall *et al.* [16] details, “the history of human cultures can be viewed as the progressive development of new energy sources and their associated conversion technologies”. Each new energy source increased EROI and thus the amount of energy available for social and economic development. Cities became possible and large community-based connected through institutions became dominant. Further energy gains reduced the cost of long-range transport and market-based connectedness became the node through which individuals and groups became connected to the massive networks of energy and material flows. How, where and to what degree one connects to resource flows depends on a person’s place in a community, market, and ecosystem.

Prior to the era of cheap high EROI energy, networks of flows of energy and material resources were far more limited than at present and connections to these networks were primarily community-based and earth based, in other words they were accessed through tribe, guild, family, clan, neighborhood, institutions of governance or directly from fields, forests and waters.

In most modern societies these networks have come to be represented by money in circulation. Each unit of currency, in effect, grants us power to lay claim to or purchase either a certain amount of embodied energy and material resources or to hold rights to claim a certain amount of future resources. The flow of money is thus the means through which present societies primarily participate in the networks of energy and material flows that structure society, whether or not we actually experience and perceive it in that way. First the invention of the global circulatory system of money, and most importantly interest and debt, followed by its computerization has created conditions in which claims and rights for access to energy and material resources has exponentially increased in volume and rate of flow. Thus claims to energy have increased enormously at the same time that EROI, and thus energy availability, is in decline.

High EROI cheap energy made possible the consolidation of international and then, global, networks of energy and material flows with greatly increased volume, velocity and geographic reach. Eventually access to these networks depended almost entirely on financial means. The connectedness that came to matter most was the connection to money. The result has been the overdevelopment of the economy of commodities (goods and services) and the underdevelopment of the economy of relations (between people and between people and the natural world). For a more complete development of this argument see Manno [17,18].

Changes in the patterns of flows, as may result from declining EROI, can trigger powerful fears and, for some, excitement at the opening of new possibilities. These periods of change are both creative (as in necessity birthing invention) and chaotic. Early 20th century historians and social theorists like Toynbee and Spengler focused on the rise and fall of civilizations. More recently others have shown the role of environmental factors, reckless consumption and resource limits in the collapse of complex societies [16,19-22].

Hall *et al.* [16] and many others have suggested that energy availability has been a very important factor in the progressive evolution of human cultures. With more energy available “progress” ensues, populations expand, and complex civilizations become possible. In other writing Hall has suggested that there may be a minimal EROI to support civilization at a given level of complexity and that declining EROI and the related impending peak in oil production threatens very large changes, perhaps even catastrophic collapse. I would argue that the cause is more likely too much energy rather than too

little. The core of my argument is that cheap energy and neoliberal ideology have combined so that an ever-increasing portion of the world's energy and material resources now flows in networks of market-based connections. This has caused critical aspects of human connectedness and social life to become systematically underdeveloped, starved of energy and material resources. As EROI continues to decline, we will need to rediscover and revitalize community-based and ecosystem-based connectedness which are required for lower energy intense forms of meeting human needs, in other words for increasing WREI.

The rise and fall of civilizations is the rise and fall of cultures that have structured people's connections with each other and to resources. Therefore the experience of decline is also experienced as a crisis of meaning. It is likely to be associated with religious conflict and cultural insecurities. New less energy-intense technologies and social arrangements will emerge. There may be conflict between those experimenting with and adopting new low-energy livelihood strategies and those clinging to old norms and beliefs associated with the outdated expectation of cheap energy. Over time, new generations may mature under conditions of more frugal flows of energy and material. One likely outcome is some combination of a renaissance of conviviality in some parts of society and globe along with conflict and decline in others, with both often occurring at the same time and place.

4. Alternative Future Scenarios: Not Just Societal Collapse

Two recent efforts have formalized alternative scenarios related to limits to growth: The Tellus Institutes' Global Scenarios for the Century Ahead: Searching for Sustainability [23] and the scenarios developed for the Millennium Ecosystem Assessment [24]. The similarity between these scenarios and others suggest that while the future may be unknowable, given energy and environment trends, plausible scenarios are not unlimited. Each project posited four scenarios they considered most plausible. Each referred to similar uncertainties: a wide range of possible climate change feedbacks and ecosystem responses, whether and how human values may change, the potential for global cooperation or conflict and many other potential feedback loops that could seriously alter any given scenario. Both seriously question the sustainability of the "business as usual" scenario and suggest social change will happen, the question is toward what end?

4.1. Tellus Scenarios

4.1.1. Conventional Worlds:

- Market Forces—Business as usual. Global incomes, GDP and population grow. Profound inequalities. Conflicts over scarce resources. Collapse.
- Policy Reform—Government directed reforms toward sustainability objectives. Serious reduction in GHG emissions. Internationally agreed poverty reduction strategies.

4.1.2. Alternative Visions:

- Fortress World—Authoritarian order imposed. Elites retreat to protected enclaves. Environmental degradation exacerbated.

- Great Transition–Values shift to a just, sustainable world. Human solidarity and environmental stewardship. Reduction in consumption through frugal lifestyles. Voluntarily reduced population pressures.

4.2. *Mea Scenarios*

- Global Orchestration–Economic cooperation, global growth, trickle-down benefits for environment and other public goods.
- Techno-garden–Ecological engineering and biotechnology follow adoption of reforms based on natural capitalism, profits from mimicking efficiencies of natural processes.
- Adapting Mosaic–Managing socio-ecological systems through adaptive management. Free flow of information, more restricted flow of trade goods and services. Great regional variation. Local/regional co-management.
- Order from Strength–Breakdown of global cooperation, authoritarian responses to social and environmental crises

It is not surprising that plausible scenarios would generally follow along the lines of business-as-usual, utopian and dystopian futures. There will be, as there always is, a struggle for the future among competing perspectives on justice, fairness, righteousness and faith. Energy analysis and social theories can inform what is possible but not necessarily what is likely. Dystopian and utopian tendencies will emerge together and the outcome may be a mix of both for a long time to come. While the state of economic disparity, global climate, biodiversity, water, etc all trend toward the dystopian, social movements are growing to bring about what the Tellus scenarios call the Great Transition and author and organizer Joanna Macy refers to as the Great Turning, the essential adventure of our time: the shift from the industrial growth society to a life-sustaining civilization. Social change activism to bring the Great Turning about groups into six forms of social change activism:

- (1) Softening the blow. On-the-ground work to protect and restore the most vulnerable and endangered ecosystems and people whether through seed banks or food banks, preserves or shelters.
- (2) Institutional and economic reform. Co-housing, web based sharing networks, and larger institutional reforms including community and earth-based stakeholder representation on corporate boards, environmental financial and tax reforms, payments for the provisioning of ecosystem services and many more policy reforms with an eye to improving wellbeing while minimizing energy and material throughput and waste. Other policies will be needed that help communities to adjust to lower levels of energy consumption. These include: reduced working hours, parental leave, benefit packages for part time work, regulation of advertising; tying corporate charters to achievement of social and environmental objectives, innovative models of local-living economies, sustainable communities and transition towns and many more.
- (3) Developing new tools and technology. The crafts of a less energy-intensive lifestyle will bring back the small-scale engineer who develops tools specific to crop, hydrology and other local ecosystem-based phenomena. These will include a range of green technologies, permaculture, ecological engineering and the like.

- (4) Developing a theory base. Intellectual work to explain how overconsumption of resources has led to environmental destruction. The field of Environmental Studies is crucial here. The development of a biophysical social theory based on thorough analysis of networks of energy and material flows could make significant contributions. Comparison of alternative patterns of energy and material use in terms of wellbeing generated per unit of energy invested (WREI) would be valuable.
- (5) Cultural work. The era of cheap energy helped market-based connectedness overwhelm the importance and awareness of culture-based and earth-based connectedness. The building and symbolizing of these “lost” connections is essential work of art, music, and poetry.
- (6) Interpersonal and psychological work. Culture alone may not be enough to bring about a new ecological consciousness. As Clive Hamilton [25] has written, it “will depend not so much on a change of beliefs and attitudes but on the emergence of a new sense of self and the relationship of that self to the natural environment. In the first instance, we therefore need to understand how people construct their sense of self, that is, how they form their personal identity and how they act out those identities in their behavior.” Can renewed forms of culture-based and earth-based connectedness help people handle the stress, fear, anger and other powerful emotions likely to be stimulated during times of major social and cultural transition? Healing from the effects of broken connections between people and the earth may be crucial throughout the transition. Self-identities formed in the age of the consumer will need to be reconstructed as people newly identify themselves as active inhabitants and participants of an ecosystem and engaged citizens in a social system. Declining EROI has the potential to reverse the emphasis back to production from consumption, to actors rather than consumers.

The negative effects of the end of cheap energy are likely to predominate unless a strong movement for social change can explain broadly what is happening and why it is happening. Such a movement must include the restoration of community-based and earth-based connectedness. If social movements pick up their pace and effectiveness in the coming period and create conditions for change that foster human wellbeing while conserving resources and reducing total system throughput, there is a chance, perhaps the only hopeful chance, for a new social renaissance as constraints on the availability of cheap energy necessitate and foster new patterns and networks of flows of energy and material resources.

References and Notes

1. Hall, C.; Powers, R.; Schoenberg, W. Peak oil, EROI, investments and the economy in an uncertain future. In *Renewable Energy Systems: Environmental and Energetic Issues*; Pimentel, D., Ed.; Elsevier: London, UK, 2008; pp. 113-136.
2. Odum H.T.; Odum, E.C. *A Prosperous Way Down*; University Press of Colorado: Boulder, CO, USA, 2001.
3. DeGrowth.net. Degrowth declaration of the Paris 2008 conference. *J. Clean. Prod.* **2010**, *18*, 523-524.
4. Schneider, F.; Kallis, G.; Martinez-Alier, J. Crisis or opportunity? Economic degrowth for social equity and ecological sustainability. *J. Clean. Prod.* **2010**, *18*, 511.
5. Daly, H. Economics in a full world. *Sci. Am.* **2005**, *293*, 100-107.

6. CASSE Center for the Advancement of the Steady State Economy. Available online: <http://steadystate.org/> (accessed on 5 February 2011).
7. Max-Neef, M. Economic growth and quality of life: A threshold hypothesis. *Ecol. Econ.* **1995**, *15*, 115-118.
8. Niccolucci, V.; Pulselli, F.M.; Tiezzi, E. Strengthening the threshold hypothesis: Economic and biophysical limits to growth. *Ecol. Econ.* **2007**, *60*, 667-672.
9. United Nations Development Program. *International Cooperation at a Crossroads: Aid, Trade and Security in an Unequal World*, UN Development Report 2005, 2005. Available online: <http://hdr.undp.org/en/reports/global/hdr2005/> (accessed on 23 October 2010).
10. Smil, V. *Energy at the Crossroads Global Perspectives and Uncertainties*; The MIT Press: Cambridge, MA, USA, 2003.
11. World Resources Institute (WRI) 2010. Earth Trends: The Environmental Information Portal. Available online: <http://earthtrends.wri.org> (accessed on 17 December 2010).
12. Lane, R.E. *The Loss of Happiness in Market Democracies*; Yale University Press: New Haven, CT, USA, 2000.
13. Goodland, R. Environmental sustainability in agriculture: Diet matters. *Ecol. Econ.* **1997**, *23*, 189-200.
14. State of the World 2004. *Worldwatch Institute 2004*; Worldwatch: Washington, DC, USA, 2004.
15. Vanderburg, W.H. *Living in the Labyrinth of Technology*; University of Toronto Press: Toronto, ON, Canada, 2005.
16. Hall, C.; Tharakan, P.; Hallock, J.; Cleveland, C.; Jefferson, M. Hydrocarbons and the evolution of human culture. *Nature* **2003**, *426*, 318-322.
17. Manno, J.P. *Privileged Goods: Commoditization and Its Impact on Environment and Society*; CRC Press: Boca Raton, FL, USA, 2000.
18. Manno, J. Commoditization and Oppression: A systems approach to understanding the economic dynamics of modes of oppression. *Ann. N. Y. Acad. Sci. Ecol. Econ. Rev.* **2010**, *1185*, 164-178.
19. Homer-Dixon, T. *The Upside of Down: Catastrophe, Creativity, and the Renewal of Civilization*; Island Press: Washington, DC, USA, 2006.
20. Diamond, J. *Collapse: How Societies Choose to Fail or Succeed*; Viking: New York, NY, USA, 2005.
21. Tainter, J.A. *The Collapse of Complex Societies*, 1st paperback ed.; Cambridge University Press: Cambridge, UK, 1990.
22. Perlin, J. *A Forest Journey*; Harvard University Press: Cambridge, MA, USA, 1991.
23. Rosen, R.A.; Electris, C.; Raskin, P.D. Global Scenarios for the Century Ahead: Searching for Sustainability. Tellus Institute Report. Available online: <http://www.mdpi.com/2071-1050/2/8/2626/pdf> (accessed on 13 November 2010).
24. MEA (Millennium Ecosystem Assessment Scenarios Working Group) 2005. Scenarion Assessment. Available online: <http://www.maweb.org/en/Scenarios.aspx> (accessed on 15 December 2010).
25. Hamilton, C. Consumerism, self-creation and prospects for a new ecological consciousness. *J. Clean. Prod.* **2010**, *18*, 571-575.

Editorial

Synthesis to Special Issue on New Studies in EROI (Energy Return on Investment)

Charles A.S. Hall

Departments of Environmental and Forest Biology and Environmental Studies, Graduate Program on Environmental Science College of Environmental Science, Forestry State University of New York Syracuse, New York, NY 13210, USA; E-Mail: Chall@esf.edu; Tel.: +1-315-470-6870; Fax: +1-315-470-6954

Received: 10 December 2011 / Accepted: 13 December 2011 / Published: 14 December 2011

Abstract: This paper is a synthesis of a series of twenty papers on the topic of EROI, or energy return on investment. EROI is simply the energy gained from an energy-obtaining effort divided by the energy used to get that energy. For example, one barrel of oil invested into getting oil out of the ground might return fifty, thirty, ten or one barrel, depending when and where the process is taking place. It is meant to be read in conjunction with the first paper in this special issue and also a number of the papers themselves. As such I try to summarize what general trends we might conclude from these varied and often highly technical papers. About half of the papers are reports on empirical analyses of various energy sources such as Norwegian or Gulf of Mexico oil, Pennsylvania gas and so on. About a quarter of the papers are methodological: how do we go about undertaking these analyses, what problems are there, what are the proper boundaries and so on. The final quarter are in a sense philosophical: since it appears that we will be living indefinitely in a world of decreasing EROIs, what are the economic, social and psychological implications? The rest of this paper summarizes the results of these studies.

Keywords: energy; EROI; economic; fuels; quality of fuels

There is, at least in my mind, a remarkable uniformity in the conclusions of essentially all of these papers, and also a very clear confirmation and continuation of the patterns derived in former EROI studies from the 1970s and 1980s but largely forgotten. The most general conclusions are that (1) traditional fossil fuels almost universally have a higher, often a much higher, EROI than most substitutes (especially when backup systems are included), (2) nevertheless, the EROI of essentially all

fossil fuels studied are declining, in many cases sharply, and (3) that the economic implications of these are enormous. I do not see within this suite of studies anything that implies a “business as usual” (*i.e.* growth) as the most likely scenario representing the future. More probably the “undulating plateau” of the past half-decade or so will continue followed by a gradual decline in the availability of our most important fuels. Even our most promising new technologies appear to represent at best minor, even trivial, replacements for our main fossil fuels at least within anything like the present investment and technological environment. Given that government and the public are fed a continual barrage of “solutions” for our energy problem (few if any with quantitative assessments) it is not surprising that there is little concern about, preparation for, or even discussion of preparations for what is likely to be a future of progressively lower net energy availability. Such a decline in net energy is almost guaranteed for the US (and much of the rest of the world) if and as conventional global oil production declines as expected, as a smaller proportion of that produced is available for export, as oil and natural gas becomes energetically, financially and environmentally more costly, as debt issues make our credit less secure, as our 104 nuclear power plants reach retirement age more or less simultaneously and as the population continues to increase. These papers collectively do not offer a clean technical solution to these issues, for depletion seems to be effectively trumping technical progress again and again.

Other main conclusions from this special issue include:

- (1) The energy return on investment for essentially all major fuels for the world (the sun driving natural processes excluded) are declining over time.
- (2) This pattern of declining EROI was found for US oil and gas (Guilford *et al.*), Norwegian oil and gas (Grandell *et al.*), Chinese oil (Yan *et al.*), California oil (Brandt), Gulf of Mexico oil and gas (Day and Moerschbaeher), Pennsylvania gas (Sell *et al.*) and Canadian gas (Freese).
- (3) The more rapidly a given fuel is exploited the more rapidly its EROI at that time declines (*i.e.* EROI for oil and gas declines more rapidly when exploitation intensity is high).
- (4) When assessments are included that include the dynamics of a ramping up a supply system the EROI is likely to become lower than what would otherwise be the case—in other words expansion itself has a large energy cost.
- (5) The EROI declines for the discovery of oil far more rapidly than for oil and gas together—in other words gas seems to subsidize oil (Guilford *et al.*).
- (6) Changes in EROI are reflected in the changing prices of fuels (King and Hall).
- (7) All estimates of EROI are likely to be overestimates because they do not include the energy costs of labor, of finance and other expenditures (Henshaw and King).
- (8) Previous criticisms of the utility of EROI because different studies gave different answers seem not to be especially valid, for the differences are due much less to different estimates of energy costs than to rather philosophical differences of what should or should not be included in costs and gains.
- (9) Different (and legitimate) questions about the boundaries of analysis or philosophies of analysis (Hall, Dale and Pimentel, Henshaw *et al.*) can be accommodated within the new EROI protocol put forth here by Murphy *et al.* The new EROI protocol offered here allows a means of allowing the use of different philosophies while providing a standard procedure that would allow comparison among studies.

- (10) EROI for the *finding* of oil and gas has declined much more precipitously than that for the *production* of oil and gas.
- (11) The only really important change since the earlier studies of the 1980s has not been any of the facts of EROI but rather the public perception of the importance of energy. This flourished during and just after the energy crises of the 1970s, then waned, and has now reemerged. The American public and its leadership are completely unprepared for the consequences.

There are many other unanswered problems to whatever new energy technologies may be coming our way: can the technical progress of photovoltaic systems be continued without using energy-intensive exotic materials, would there be enough copper and other materials, can backup systems be derived for massive wind power systems without bringing the EROI down to unmanageable levels? Can we have anything like our present level of affluence and civilization on fuels of modest EROI? And then there is the question of coal: this remains abundant in the US and several other areas of the world but its environmental problems are of course very severe. Because of the environmental concern about nuclear power and the decline in available oil or at least its growth the increased energy use in the US and other large countries has normally fallen by default to coal. This is likely to continue without some kind of coordinated plan.

Curiously the importance of EROI studies has escaped the notice of our major funding agencies and nearly all of the research reported on here was done without any governmental, or other, funding. We thank all those who believe so strongly in this issue that they were willing to undertake these studies “*pro bono*”. This special issue has not covered several other issues that are likely to be critical. One in particular is the issue of investments. As it stands the price of gasoline at the pump covers only the cost of extracting and refining the oil, it does not cover the cost of replacement, were that possible. Hence when the majority of the existing reservoirs are pumped dry will the public be willing to pay double the otherwise high cost of gasoline to pay for the investments into whatever alternative fuels are available? Some may already be doing that through the very high cost of electric vehicles. What if fleets of electric vehicles add large loads to already overburdened electric utility lines? Who pays for the upgrades?

All of these issues need to be dealt with in some kind of massive objective synthesis. Instead there are advocacy groups for and against each individual fuel with little understanding that arguing against one fuel almost certainly means encouraging another (as in the nuclear-coal issue above). “Green technologies” are not displacing fossil fuels, whose use continues to grow, but simply adding a little to the mix. Large energy companies are easy targets and they certainly do many foolish things. But basically they are doing no more than what citizens are asking for: provide more power for an energy-intensive life style. Even our largest oil companies that periodically make massive and alienating profits are just average with respect to corporate profits when measured over a decade, as they tend to have years with very poor returns as well. Pharmaceutical and soft drink companies have far higher profit rates. If you personally do not like the actions of oil companies that is fine, but I would suggest that you stop buying gasoline or using a bus before you cry out too much. Also there is little understanding that while one fuel or another does indeed tragically kill a dozen miners here or oil workers there (as in any huge industry), that collectively our energy-intensive industrial society has saved probably billions of lives and added decades to our life spans. This is through better nutrition,

more even experienced temperatures and the whole health-medical establishment, all of which are very energy-intensive.

Clearly a massive analysis is necessary to understand all of these questions. There has been little leadership from Washington, especially on the need for massive conservation, but rather cheerleading for technologies that offer little. Most obviously the large federal encouragement for corn-based ethanol has generated a vast bureaucracy that has provided little or no net fuel to the nation despite many scientific studies that indicated long ago that the net contribution of this fuel, even not accounting for the soil erosion, was quite marginal at best. Universities are probably the best vehicles for providing this assessment but funding for such analyses, or even to develop sufficiently well-trained man and woman power, make even this inexpensive and logical step rather unlikely in today's political climate. Given the connection between EROI and fuel price shown by King and Hall in this issue it seems that markets will continue to maintain fossil fuels as dominant fuels until their own EROIs, including backups and perhaps environmental issues, are in the same range, if that ever occurs. Despite all the rhetoric the proportional contribution of oil, gas and coal has not changed much at all since the 1970s. Even if some magic new technology is found, encouraged and the necessary investments are found it is likely to have a low EROI relative to traditional fuels. If it were to grow exponentially it could be a sink of net energy from society for some time, even decades (see Deng and Tyron [1], this issue, and Gutowski *et al.* [2]). There are no simple solutions to our energy dilemma and they need to be understood much better, especially with respect to economics. We try to do that in a new book [3] which examines how we might think quite different about economics from the perspective of energy and all of the issues identified here.

Acknowledgments

I thank all authors and reviewers for this special issue. I also thank Ajay Gupta for help with this chapter.

Conflict of Interest

There are no conflicts of interest associated with this paper.

References and Notes

1. Deng, S.; Tynan, G.R. Implications of energy return on energy invested on future total energy demand. *Sustainability* **2011**, *3*, 2433-2442.
2. Gutowski, T.G.; Gershwin, S.B.; Bounassisi, T. *Energy Payback for Energy Systems Ensembles during Growth*; Institute of Electrical and Electronics Engineers (IEEE): New York, NY, USA, 2010.
3. Hall, C.A.S.; Klitgaard, K. *Energy and the Wealth of Nations. Understanding the Biophysical Economy*; Springer: New York, NY, USA, 2011.

Aims

Sustainability (ISSN 2071-1050) is an international and cross-disciplinary scholarly journal of environmental, cultural, economic and social sustainability of human beings, which provides an advanced forum for studies related to sustainability and sustainable development. It publishes reviews, regular research papers, communications and short notes, and there is no restriction on the length of the papers.

Our aim is to encourage scientists to publish their experimental and theoretical research relating to natural sciences, social sciences and humanities in as much detail as possible in order to promote scientific predictions and impact assessments of global change and development. Full experimental and methodical details must be provided so that the results can be reproduced.

There are, in addition, unique features of this journal:

- manuscripts regarding research proposals and research ideas will be particularly welcomed
- electronic files or software regarding the full details of the calculation and experimental procedure, if unable to be published in a normal way, can be deposited as supplementary material
- we also accept manuscripts communicating to a broader audience with regard to research projects financed with public funds

Please see the Scope of Sustainability at www.mdpi.com/journal/sustainability/about.

Sustainability Indexing & Abstracting

Sustainability is covered by following indexing and abstracting databases: CAB Abstracts, Chemical Abstracts (CAS), Directory of Open Access Journals (DOAJ), e-Helvetica (Swiss National Library Archive), EBSCOhost, EconPapers, Food Science and Technology Abstracts (FSTA), Google Scholar, IDEAS, INSPEC, RePEc, Scopus / SciVerse.

MDPI journals are generally Medline indexed and available in [PubMed](https://pubmed.ncbi.nlm.nih.gov/) where appropriate; we understand the importance of this. We submit our journals to be considered for retrospective Medline indexing as soon as they are eligible.

We understand the importance of coverage in the [Web of Science](https://www.webofscience.com/). This journal has been submitted for evaluation to receive an impact factor as soon as possible.

Sustainability is published by MDPI monthly. If you would like to submit a paper, please first visit the Instructions for Authors website (www.mdpi.com/journal/sustainability/instructions/). Manuscripts should be submitted through the online manuscript submission and editorial system at www.mdpi.com/user/manuscripts/upload.

MDPI publishes several peer-reviewed, open access journals listed at www.mdpi.com. All MDPI journals maintain a rapid, yet rigorous, peer-review and editorial processes.



Final Acknowledgements

I would like to thank the guest editor Prof. Dr. Charles A.S. Hall and associate editor Mr. Doug Hansen of this special issue "New Studies in EROI (Energy Return on Investment)" for the excellent job. I would also like to thank the authors for so many relevant and high quality papers within the specific topic of this special issue, which together are an important contribution to studies on sustainability.

Finally, I would like to use this opportunity to extend a general invitation to scholars whose expertise matches the interdisciplinary areas of sustainability to submit their original research articles or reviews to our journal Sustainability. Further, we also welcome proposals from scholars interested in guest editing a special issue for our journal; please contact the Editorial Office at sustainability@mdpi.com.

Sincerely,

Dr. Shu-Kun Lin

Publisher

This book contains the printed edition of the special issue on New Studies in EROI (Energy Return on Investment) that appeared in *Sustainability* (<http://www.mdpi.com/journal/sustainability/>). *Sustainability* (ISSN 2071-1050; CODEN: SUSTDE) is an international and cross-disciplinary, scholarly, open access journal of environmental, cultural, economic and social sustainability of human beings, which provides an advanced forum for studies related to sustainability and sustainable development. *Sustainability* is published by MDPI online monthly.

Multidisciplinary Digital Publishing Institute (MDPI)
Basel, Switzerland

ISBN: 3-906980-31-6