

[https://www.iaea.org/sites/default/files/21/10/iaea\\_webinar\\_marine-based\\_smrs-merged.pdf](https://www.iaea.org/sites/default/files/21/10/iaea_webinar_marine-based_smrs-merged.pdf)

# BANDI-60: Technology Features and Deployment Pathway

- IAEA Webinar : Advances in Reactor Technologies for Marine-based Small Modular Reactors -

**May 18, 2021**

**B. J. Lee**

**NSSS Design & Development Division**

**KEPCO E&C**

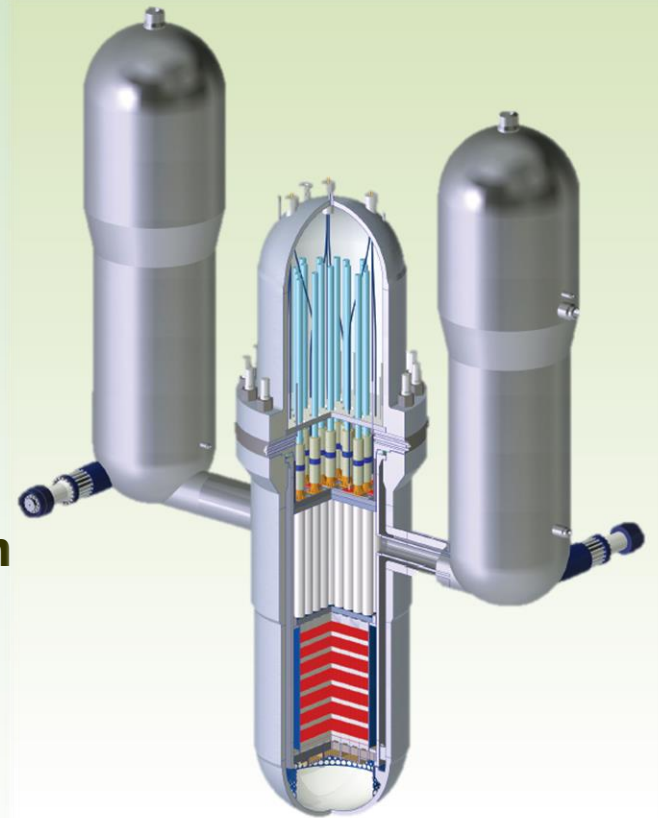

# KEPCO E&C is ...

- Founded in 1975.
- Offering full scope of engineering services for nuclear power plants in Korea and overseas.
  - ✓ Nuclear steam supply system (NSSS)
  - ✓ Architect engineering (AE) and BOP systems
- Played a key role in developing and deploying OPR1000 and APR1400 in Korea and abroad.
- **As for the SMRs,**
  - ✓ Involved in the KAERI's SMR SMART project, and
  - ✓ **Have a dream to bring out our own SMR BANDI reactors in the future.**

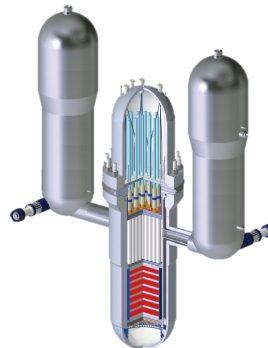
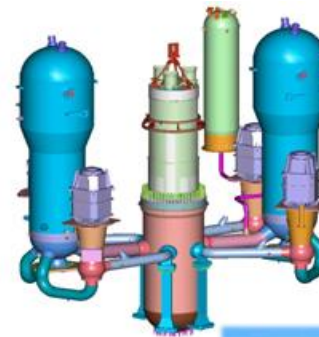
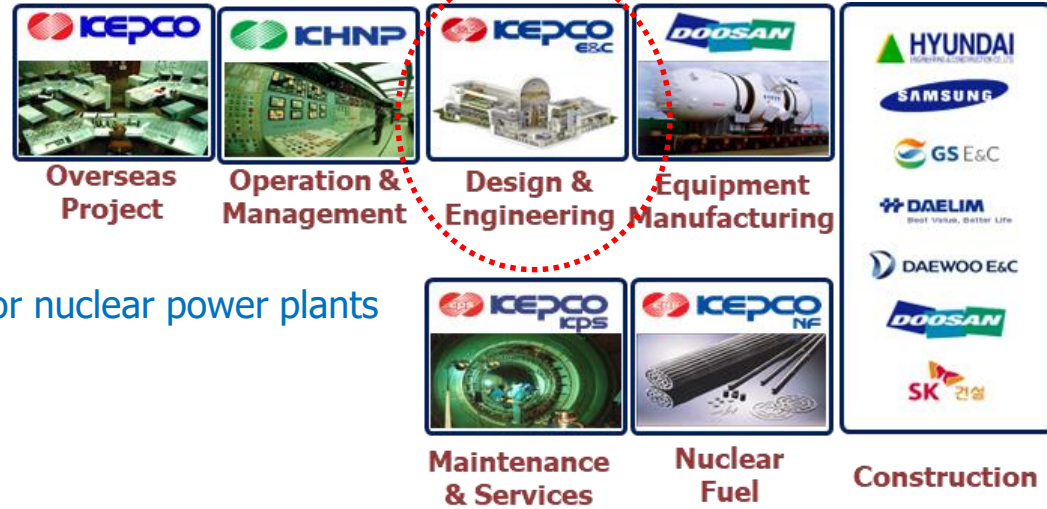

# Our View on the SMR Market

- **Small reactors, hard to compete in the conventional electrical market**
  - ✓ They say SMR's economy comes from the 'Economy of Mass Production' or 'Economy of Multiples'
  - ✓ However, *without a big work volume for a standardized model, the economy would not be achievable.*
- **We believe SMRs should aim for Niche market** such as:
  - ✓ **Distributed energy sources** (power, heat) for remote or isolated areas
    - Where populations are scarcely distributed over wide area
  - ✓ **Industrial process heat**
    - Replacing fossil fuel boilers
  - ✓ **Marine-based nuclear power systems, etc.**
    - Floating nuclear power plants, propulsion for bulky merchant ships, etc.



# We aim for More Versatile Applications in Niche Market

## NOT Want to Compete with Large Ones

Power (MWe)		Applications	Remarks
<b>Large</b>	>700	✓ Power supply for big electrical grids	<b>Electric power market</b>
<b>Medium</b>	300 ~ 700	✓ Power supply for smaller electrical grid (small or developing countries) ✓ Replacement of old fossil power plants	
	200 ~ 300	✓ Similar to those of medium reactors	
<b>Small</b> 	<b>20 ~ 200</b>	✓ <b>Local power &amp; heating</b> ✓ <b>Industrial process heat ...</b>	<b>Niche market</b>
	~ 20	✓ Energy supply for isolated sites (electricity, heating) ✓ Special purposes	

# Our SMR, BANDI-60

An Option for Floating Nuclear Power Plants

Under development since 2016



# Key Design Features of BANDI-60

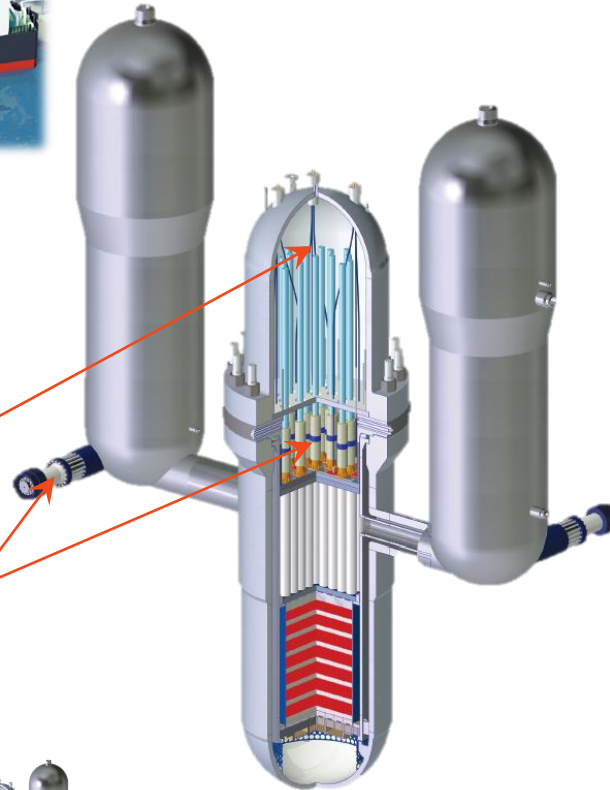
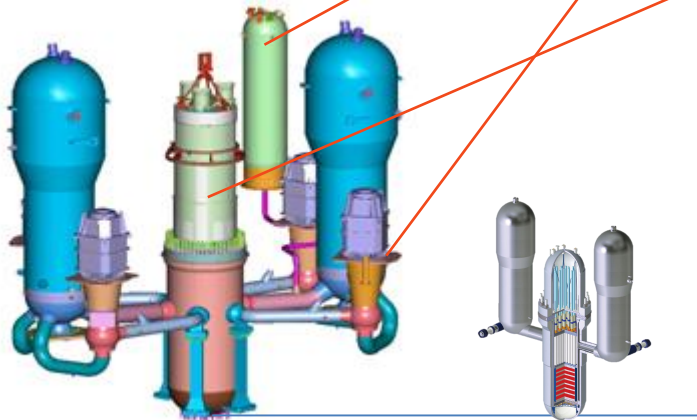
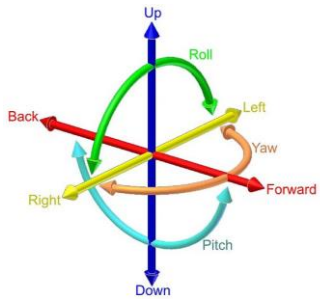

- Nozzle-to-nozzle connection between Reactor block and SG block
- Soluble boron free
- In-Vessel CEDM
- Top-mounted ICI
- Fully passive safety
- Canned-motor RCPs
- Integral pressurizer
- Steel containment vessel (compact and high pressure)
- Enhanced load following
- ...

# Preliminary Design Parameters of BANDI-60

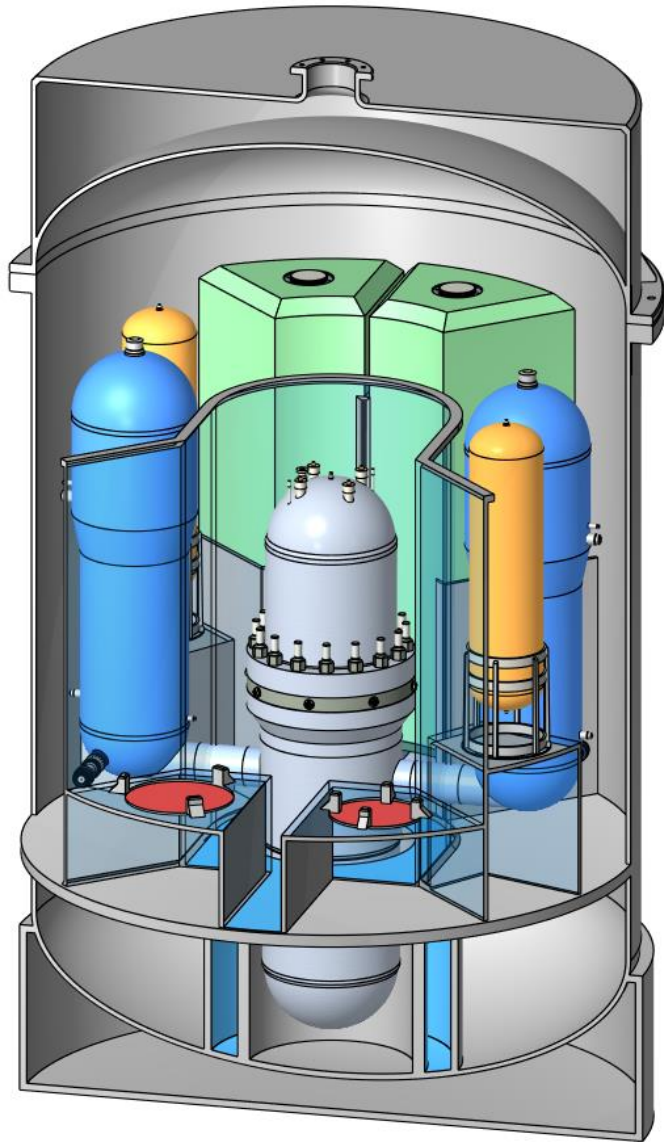

Parameters	Values or Descriptions
Reactor type	PWR with a Block-type arrangement
Thermal/electrical output	200MWt / 60MWe
Primary flow circulation	Forced circulation
System pressure	15 MPa
Core temperature	290°C (Cold Leg) / 325 °C (Hot Leg)
Reactivity control mechanism	Control rods with In-Vessel CEDM & Secondary Shutdown System
Steam Generator type	U-tubes (Recirculation, Saturated steam) or Plate-shell
Steam pressure	6 MPa
Design life	60 years
RPV height /diameter	11.2 m / 2.8 m
Reactor Coolant Pump	Rated Head : 36.2 m Rated Flow Rate : 40.2 m <sup>3</sup> /min
Core Makeup Tank	10 m <sup>3</sup>
Emergency Core Cooling Tank	50 m <sup>3</sup>

# Now in a Conceptual Design Phase

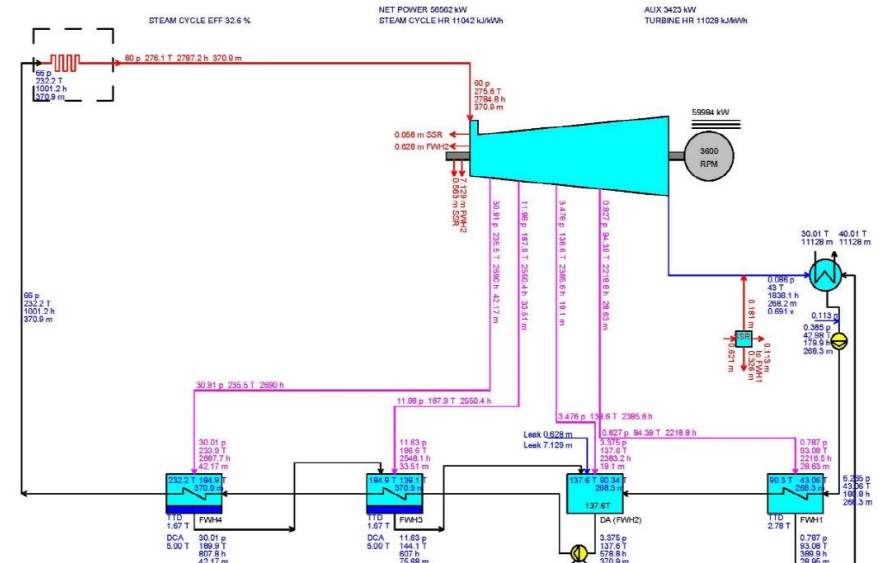
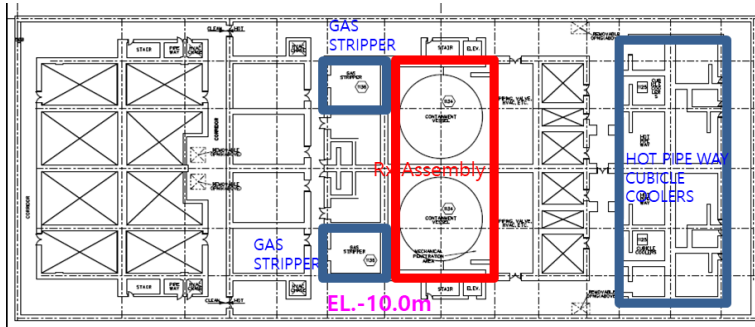
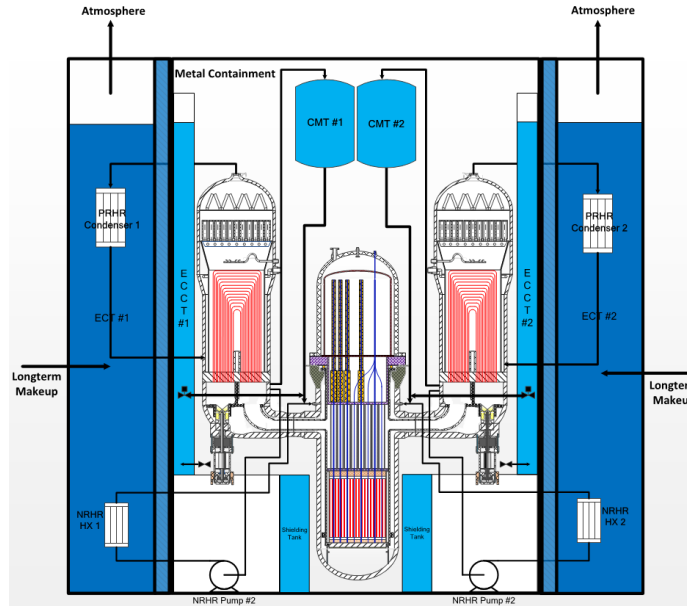
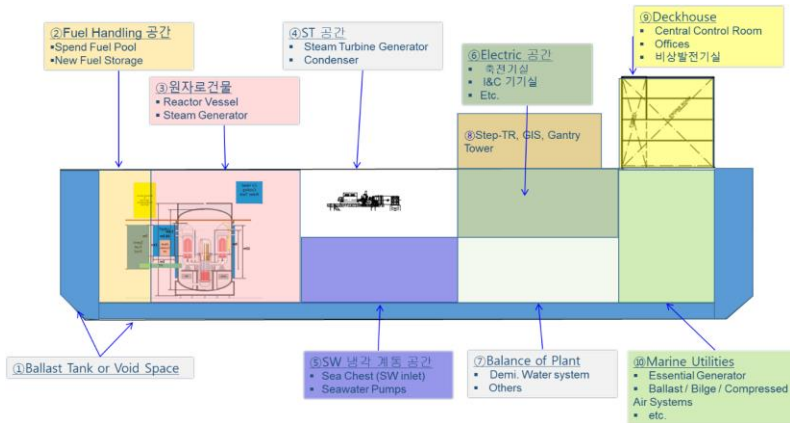



# Iterative Works underway for Design Optimization

- ✓ Closely-coupled thermo-hydraulic interactions among the reactor, passive safety systems and steel containment vessel
- ✓ Iterative feedbacks between "Design" and "Analysis"

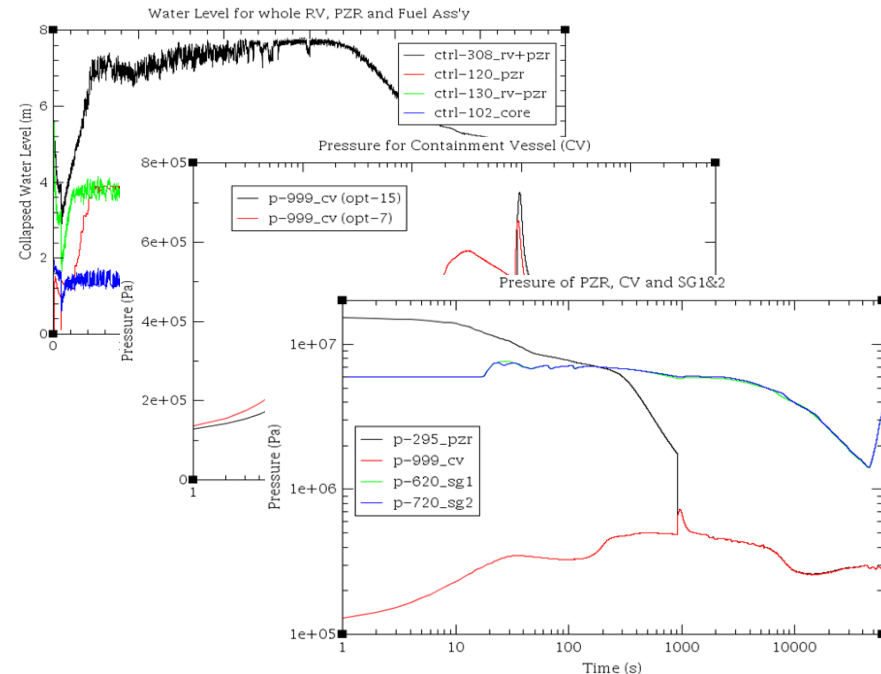
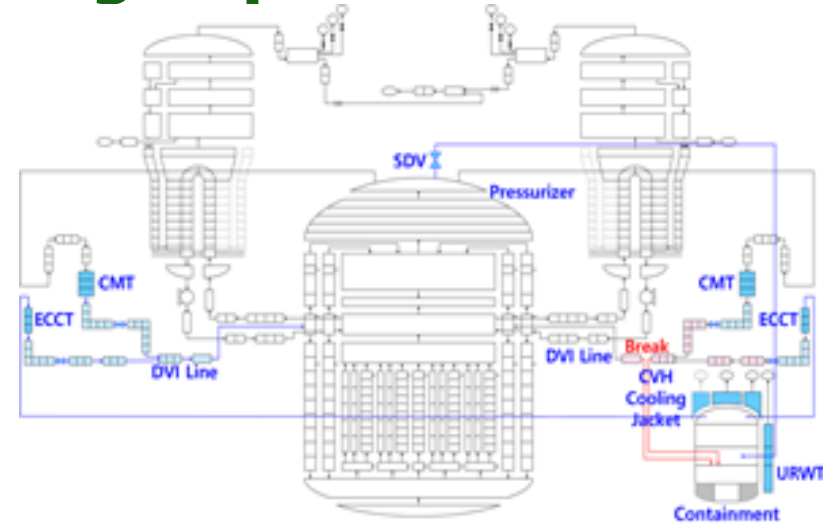
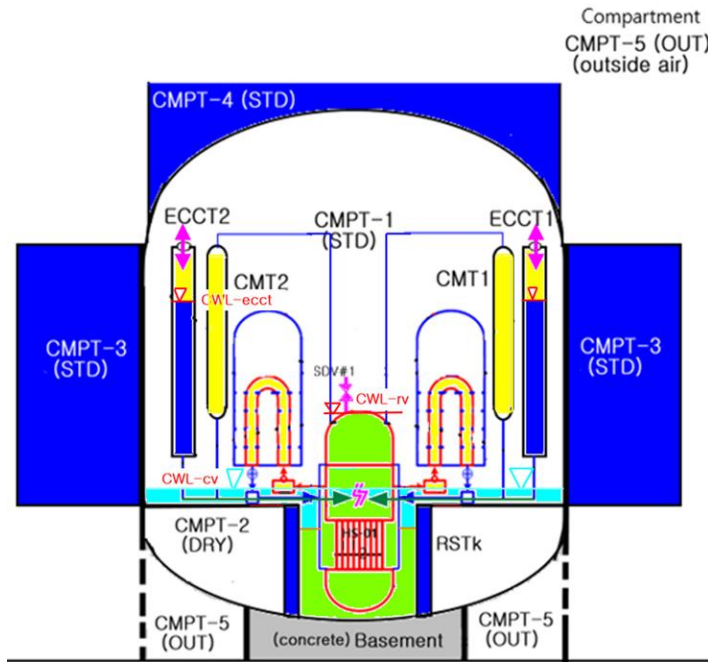

# Our Long-term Plans for the Future (1/2)

- **Build up our capability**

- Make full use of our expertise on water-cooled reactor technologies
  - ✓ Minimize technical and licensing risks

- **Develop Business Models**

- Convergence of Technologies : Nuclear, Renewables, Energy Storages, Marine Shipbuilding, ...
  - ✓ Renewable & nuclear hybrid energy systems
  - ✓ Floating nuclear power plants ...

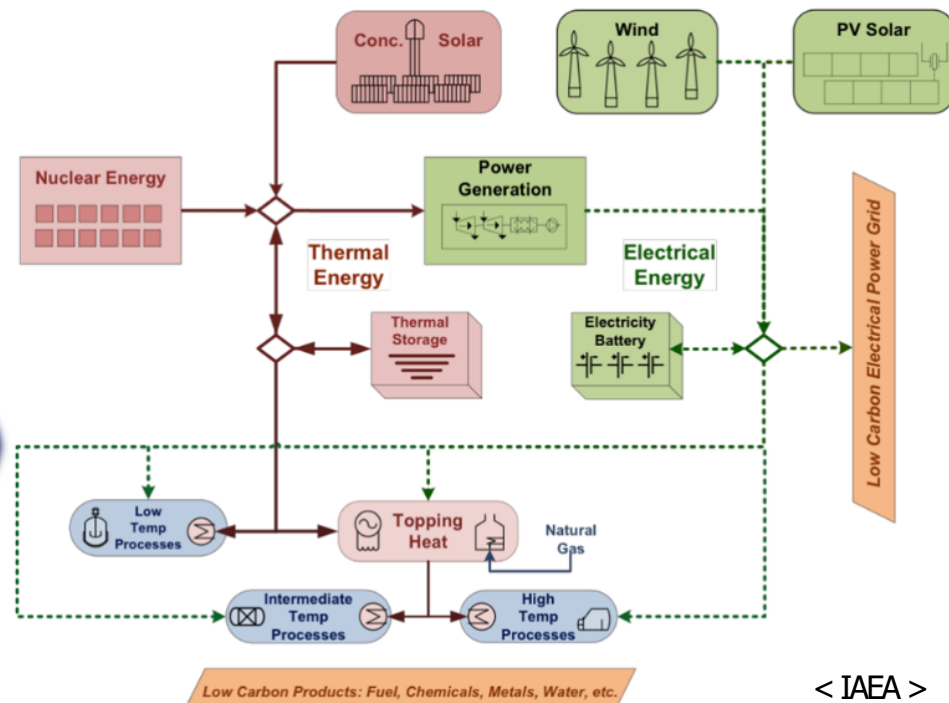
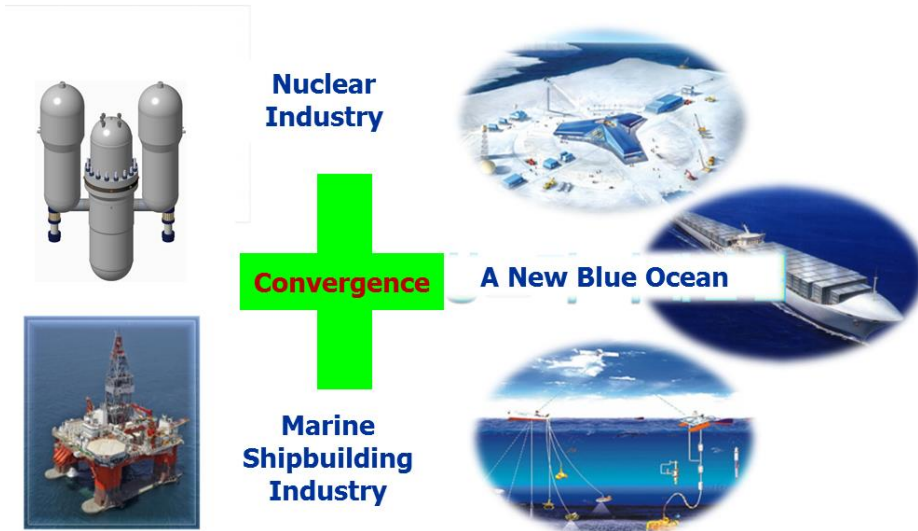

< IAEA >

# Our Long-term Plans for the Future (2/2)

- **Share Dreams and Work Together**

- Crucial to make it a real business

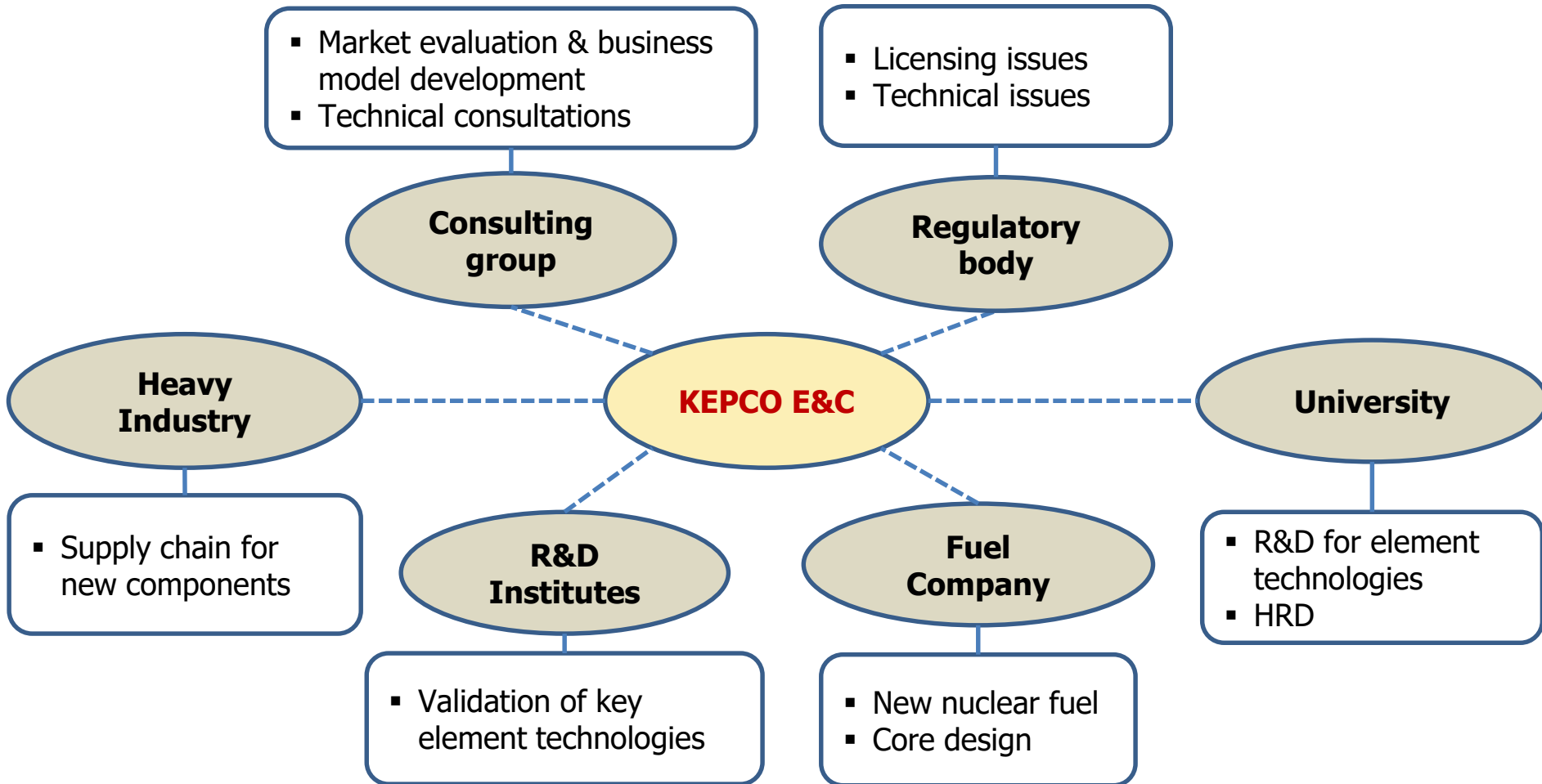

**Thank You!**





AFRIKANTOV  
OKBM  
ROSATOM

# SMR Based Floating Solutions: Design and Specific Features of Legal Regulation

**Nadezhda Salnikova**

Head of Business Development Department  
JSC “Afrikantov OKBM”

# ROSATOM: ALL THAT IS NUCLEAR

## ENERGY SECTOR

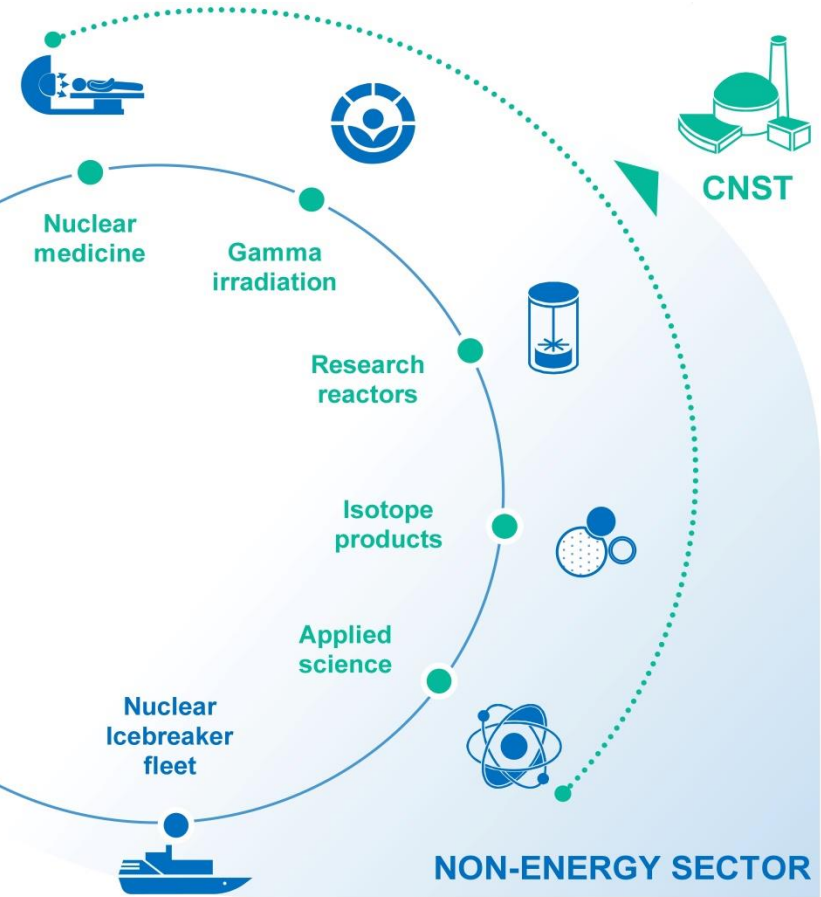
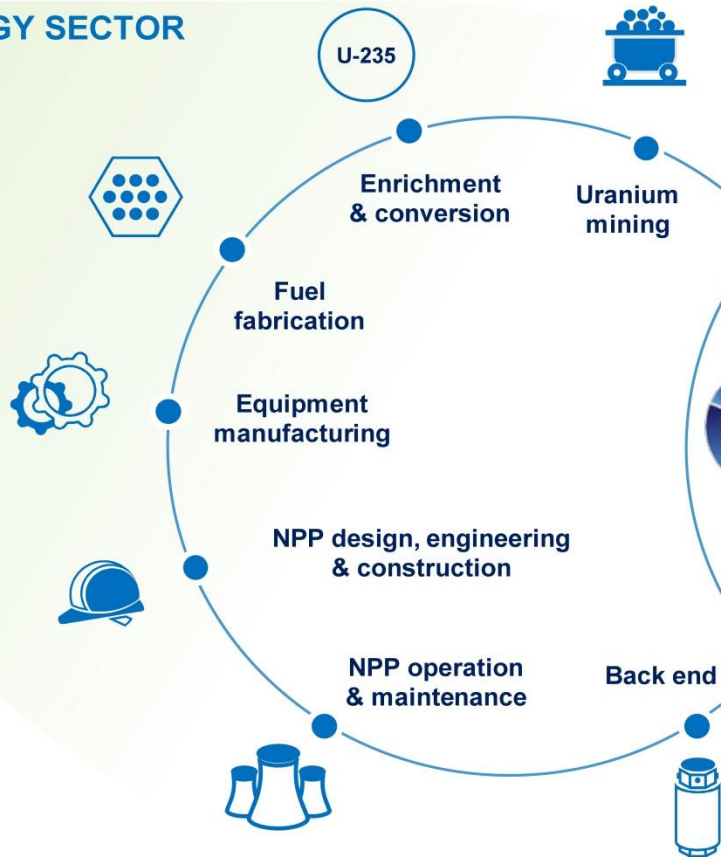

# JSC «Afrikantov OKBM» – scientific and production centre of atomic mechanical engineering of the Rosatom State Corporation



Date of foundation – December 27, 1945

Decorations: Order of Lenin (1960), Order of the October Revolution (1985).

The mission of JSC “Afrikantov OKBM” is to serve for national interests and development of nuclear industry providing full spectrum of services regarding designing, construction, procurement of nuclear reactors and their maintaining during life cycle.



<b>Personnel</b>	<b>3850*</b>
• designers and technologists	1044
• test engineers	142
• production workers and foremen	1500
• auxiliary services	1092
• supervisors	72
<b>Middle age</b>	<b>43</b>
<b>Percentage of employees aged 35 and younger</b>	<b>30%</b>
<b>Employees who have academic degrees</b>	1 academician of the RAS
	19 doctors of science
	83 candidates of science
	6 professors
	8 docents
<b>Russian Government awards in science and engineering</b>	<b>47 awards 96 laureates</b>
<b>Honoured workers in science and engineering</b>	<b>70</b>

\* – average number of employees as of December 31, 2019

# From icebreakers to floating nuclear power plants: nuclear energy sources in the Arctic



OK-900  
OK-900A



KLT-40  
KLT-40S



RITM-200  
RITM-200M



RITM-400

**Icebreaker «Lider»**  
Basic design  
Planned commissioning  
— 2027



159–171  
MW



135–171  
MW



175  
MW



315  
MW

Reactor nominal  
thermal capacity



**FPU «Akademik Lomonosov»**  
Commissioned in 2020



**OFPU**  
Conceptual design  
Planned  
commissioning —  
2028



# Reference project: FPU «Akademik Lomonosov»

**Commercial operation of FNPP\*  
on the basis of FPU\*\* «Akademik  
Lomonosov» was commenced on  
May 22, 2020**



The project is implemented in accordance with legal requirements of the Russian Federation established for nuclear vessels and floating structures taking into account recommendations of the IAEA.

**Experience of KLT-40S  
operation:  
2 nuclear icebreakers,  
1 nuclear-powered cargo  
ship and 1 FPU**

Power supply solutions have been tested on nuclear icebreakers



KLT-40S

**Feasibility of floating power units is proved  
TRL 7**

2 reactor facilities	KLT-40S
Operational life	40 years
Period between refueling	3–4 years
ICUF	0,7
Net output:	
Electricity	20...70 MW
Heat	50...146 Gcal/h

\*FNPP – floating nuclear power plant

\*\* FPU – floating power unit

# Optimization of technical solutions

The most efficient design is a balanced solution based on all factors

Designing is an iterative process influenced by all factors in a reciprocal way

## Factors that influence product development

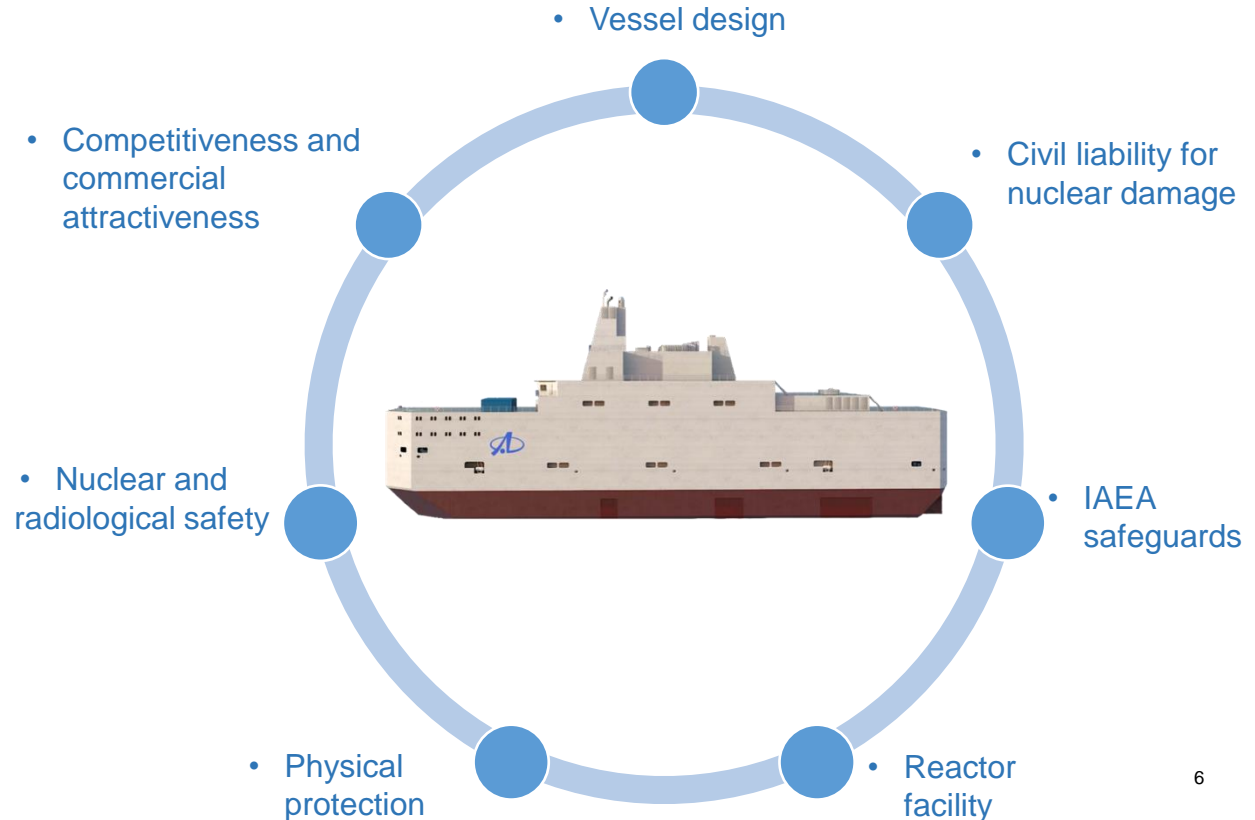

# Optimization of solutions for floating design energy sources

Increasing:

- electrical output up to 100 MW
- refueling interval up to 10 years

Ship optimization

- no refueling equipment on board
- cost reduction
- decreasing ship principal dimensions

Two versions of OFPU:

- **self-propelled** ( self-moving and positioning in open water areas)
- **non-self-propelled** (a berth-connected ship, relocation on board of a semi-submersible heavy-lift vessel or by towage)

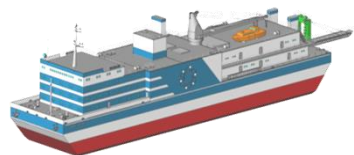
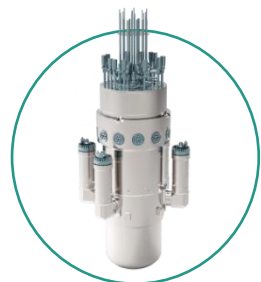

FPU «Akademik Lomonosov»



- expansion of functionality
- versions for arctic and tropical climate



Optimized floating power unit (OFPU)

2 reactor facilities	RITM-200M
Electrical capacity	2*50 MW
Operational life	60 years

	FPU «Akademik Lomonosov»	OFPU
Length	140 m	112 m
Breadth	30 m	30 m
Draught	5,6 m	5 m
Displacement	21 000 t	16 680 t

# Solutions for international markets.

## Implementation of projects according to BOO business scheme



Conception of cyclic replacement «n+1» implies construction of the energyfleet that consists of several OFPUs, one of which is for temporary replacement

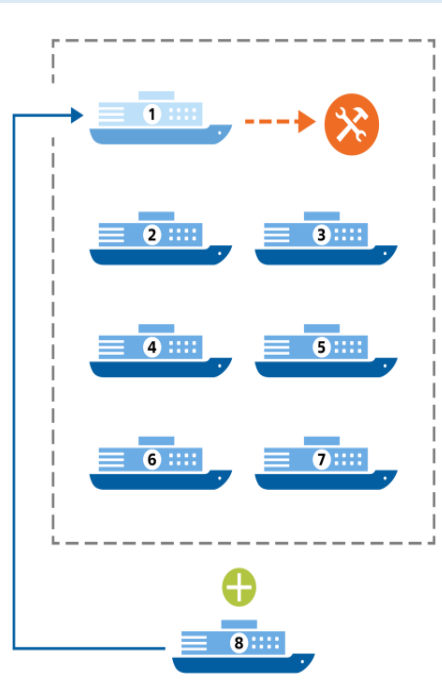



- Consecutive commissioning of identical OFPUs
- OFPU that is for replacement is used as substitute power-generating capacity instead of the first power unit, which is moved to Russia for maintaining and refueling
- OFPUs are replaced one by one providing lack of downtime in energy supply

### Advantages of Conception «n+1» for customers:

1. Unique business-model that can not be implemented on the basis of land-based nuclear power plants
2. Unified, interchangeable floating power units
3. Simplified licensing
4. Financial and infrastructural burden for customers is minimized
5. Benefits from supplier's capacities that has a wide experience of operation of icebreakers. There is an opportunity of engaging supplier's employees.
6. Project efficiency as a result of minimized downtime in energy supply

# OFPU legal regulation

OFPU has features of	
a vessel	a nuclear power plant
	
Existing regulatory framework established in Russia fully covers all aspects of the life cycle, and enables OFPUs and other floating power units to be operated.	

Self-propelled vessels with nuclear reactors have already accomplished several international voyages



Savannah

Otto Hahn

Sevmorput

Existing international regulatory framework does not prohibit OFPU operation, however, specialized requirements for non-self-propelled floating units with nuclear power facility do not exist.



It is needed to establish safety criteria for non-self-propelled floating units with nuclear power facility that would meet international approval. These criteria would give an opportunity:



*Safety assessment*\* is assumed to be a possible solution. It is obligatory for self-propelled nuclear vessels and it can be adjusted to non-self-propelled floating units with nuclear power facility.

to developers and operators: to develop a required scope of documentation in advance in order to prove safe operation

to stakeholders: to objectively assess safety of operation

\* Safety assessment is required by SOLAS-74 and by Code of safety for nuclear merchant ships Res. A..491 (XIII) passed by International Maritime Organization

# Work streams in creating legal and regulatory environment for floating power units

- Further development and enhancement of national regulatory system concerning safety of floating power units
- Analysis of application of the IAEA safety recommendations to SMRs (in terms of the project *Applicability of the IAEA Design Safety Guides to Innovative Small Modular Reactors*)
- Assessment of SMRs including OFPU using INPRO methodology\*
- Project INPRO TNPP-2 «Case Study for the Deployment of a Factory Fueled SMR»:
  - Scenarios of deployment of land-based, floating and submersible SMRs are reviewed. These SMRs are factory fueled and they can be transported to an operating site in foreign countries;
  - Issues of legal requirements for transportation, nuclear safety, IAEA safeguards, physical protection, licensing, etc. are analyzed;
  - Recommendations for decision-makers on deployment of SMRs are developed.
- Other projects under the aegis of the IAEA, OECD and other international organizations

# Regulations for the Safe Transport of Radioactive Material No. SSR-6 (Rev. 1)

At the present time SSR-6 is not included in the list of documents that are under analysis

Types of transportable nuclear modules (TNM)  
and the ways of their transportation with fuelled reactor



Floating TNM

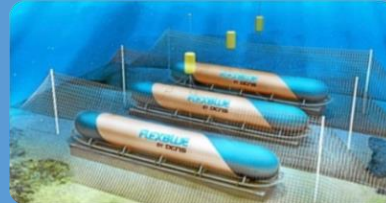

Submersible TNM



Land-based TNM

The current version of SSR-6 is not applicable to the regulation of TNM transportation\*:

- SSR-6 is limited to the transportation of nuclear materials in containers.
- Unlike containers nuclear reactors are aimed to ensure controlled nuclear fission chain reaction.
- Nuclear reactors do not comply with requirements of SSR-6 on containers testing.
- Safety of OFPU transportation with a reactor in shutdown condition should be substantiated in a Safety Assessment Report.

In order to from transparent and agreed rules of safe TNM transportation it is needed to

- ❖ exclude TNM from the scope of applicability of SSR-6
- ❖ Initiate development of a new document that will regulate safety of fuelled TNM transportation under the aegis of the IAEA

# Conclusion

1. FPU «Akademik Lomonosov» has proved feasibility of floating power units.
2. Optimized floating power unit is developed as a solution for international markets with regards to relevant approaches to nuclear and radiological safety, safeguards against the proliferation of nuclear weapons, physical protection, civil liability for nuclear damage, etc.
3. Formation of a common legal framework is one of the most important conditions of successful implementation of innovative projects of optimized floating power units.
4. Development of innovative technologies of small modular reactors is possible only with the support of the IAEA concerning interpretation of safety issues of innovative technologies and adaptation of existing safety guidelines in relation to new projects of SMR.



OFFSHORE FLOATING NUCLEAR PLANT

**OFNP**

A stylized atomic symbol logo consisting of three overlapping elliptical orbits in a light blue color, centered behind the acronym 'OFNP'.

AFFORDABLE - SAFE - FLEXIBLE NUCLEAR ENERGY

# Offshore Floating Nuclear Power Plant (OFNP)



J. Buongiorno, [Jacopo@mit.edu](mailto:Jacopo@mit.edu)

M. Golay, [golay@mit.edu](mailto:golay@mit.edu)

N. Todreas, [Todreas@mit.edu](mailto:Todreas@mit.edu)



# Offshore floating nuclear power plant (OFNP)

## A New Paradigm for Construction, Siting and Operations of Nuclear Plants

- Nuclear Power Plant siting concept, suitable for almost any reactor
- Shipyard fabrication to control capital costs
- Seismic and tsunami protection
- Passive cooling to Ocean
- No Emergency Planning Zone
- International siting

# OFNP's top-tier safety objectives are inspired by the Fukushima lessons learned

- Eliminate earthquakes and tsunamis as accident precursors
- Eliminate the loss of ultimate heat sink, to reduce the core damage frequency ( $\ll$  once in 100,000 years)
- Eliminate radioactivity releases, should a severe accident occur
- Eliminate the possibility of land contamination, should a release occur

# The offshore floating nuclear power plant combines two mature and successful technologies



**Floating rig**

+



**Nuclear reactor**

=



**OFNP**

≈ 800 naval reactors (>> total commercial power reactors)

# The Offshore Floating Nuclear Power Plant Concept

- Built in a shipyard and transported to the site: reduced construction cost and time (target is <36 months); enhanced quality



# The Offshore Floating Nuclear Power Plant Concept (2)

- Quick and cost-effective decommissioning in a centralized shipyard (U.S. sub and carrier model): return to “green field” conditions immediately
- Moored 10-20 km offshore, in relatively deep water (~100 m): no earthquake and tsunami concerns
- Nuclear island is underwater: ocean heat sink ensures indefinite passive decay heat removal



# Design – Reactor



Class 1100-MW plant features Westinghouse's AP1000 reactor:

- NRC-certified
- Standard  $\text{UO}_2$  fuelled core
- No new materials, fuels or components need to be qualified

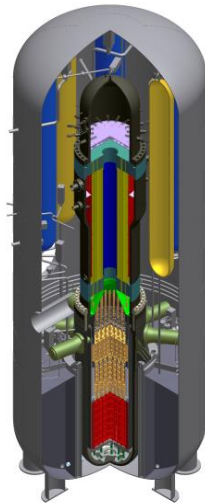

Class 300-MW plant has an integral PWR (e.g. WSMR)

- All primary system components within a single pressure vessel
- Compact, high-pressure containment

Other reactor designs are possible



## Design – Platform

- Spar-type floating platform
- Simple, stable and cost-effective design

**OFNP-300  
(300 MW<sub>e</sub>)**



Draft / Height : ~49 / 73 m  
Diameter: ~45 m  
Displacement: ~72,000 ton

Natural heave/pitch period:  
~21/23 sec

**OFNP-1100  
(1100 MW<sub>e</sub>)**

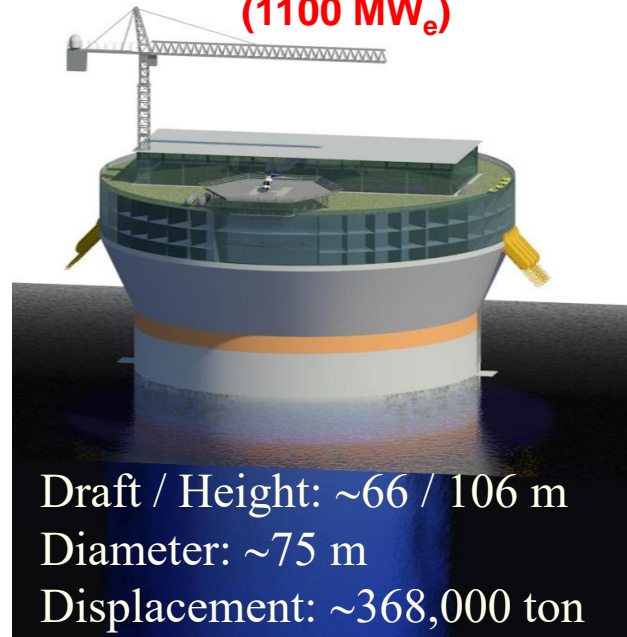

Draft / Height: ~66 / 106 m  
Diameter: ~75 m  
Displacement: ~368,000 ton

Natural heave/pitch period:  
~22/36 sec

Natural period must be < tsunami wave period (plant rides tsunami)  
and > peak storm wave period (minimized oscillations in storms)

# Defense in Depth

- OFNP has two additional barriers
- OFNP EPZ is at sea

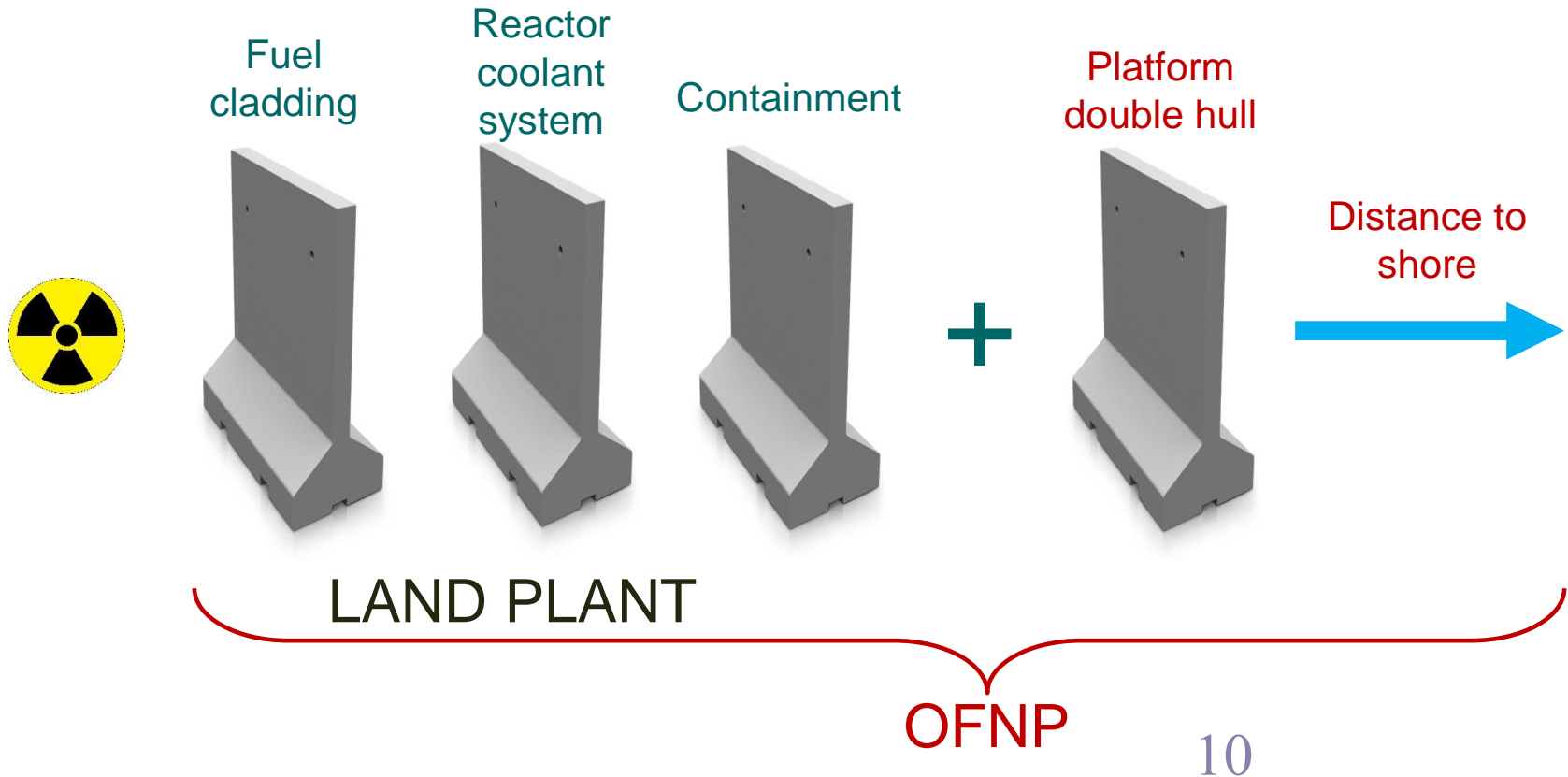

# Design – Platform

- All safety-critical components are in water-tight underdeck compartments
- High deck enhances security
- Minor maintenance at sea; major infrequent (~10 years) maintenance in centralized shipyard
- Operate in monthly or semi-monthly staff shifts with onboard living quarters (oil/gas offshore platform model)
- Flexible refueling (12-48 months); spent fuel stored in pool designed for plant lifetime, with passive decay heat removal system
- Includes desalination units + condensate storage tank for water makeup

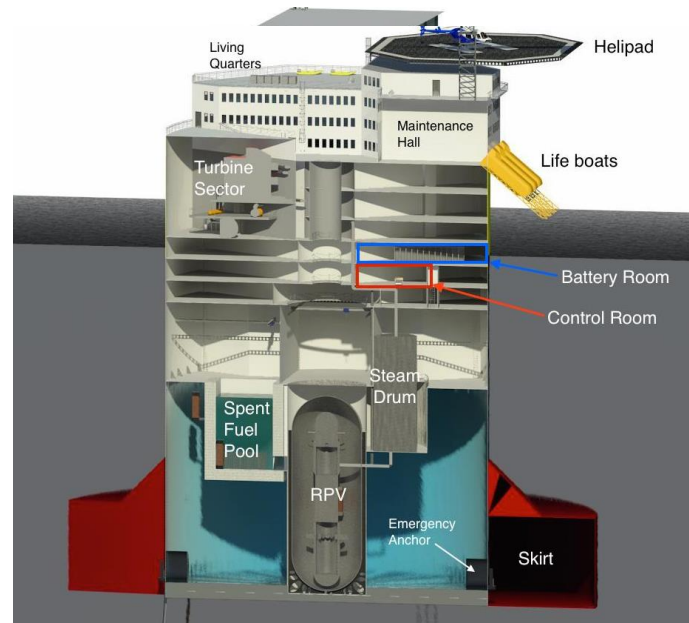

# Design – Platform

- Double hull + all levels at the waterline and below are water-tight with azimuthal bulkheads
- >90% reduction in structural concrete vs. terrestrial plants
- Operate in monthly or semi-monthly shifts with onboard living quarters (oil/gas offshore platform model)

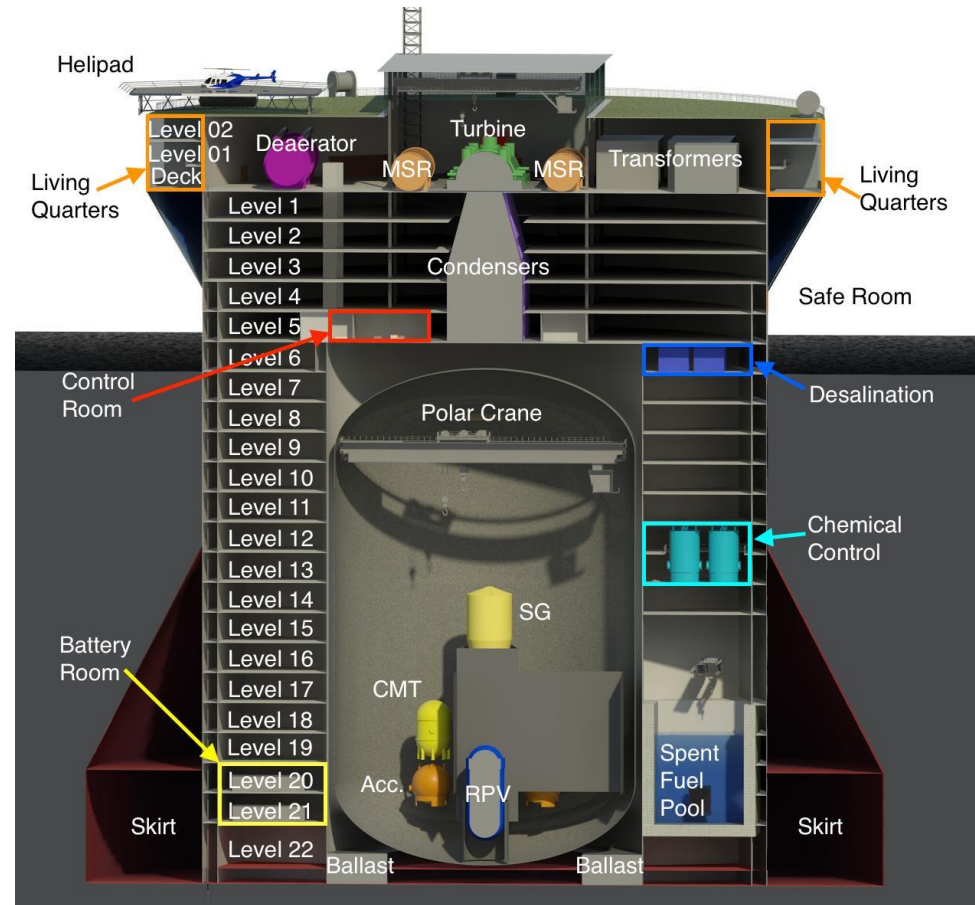

- Spent fuel stored in pool designed for up to plant lifetime, with passive decay heat removal system

# Defense in Depth

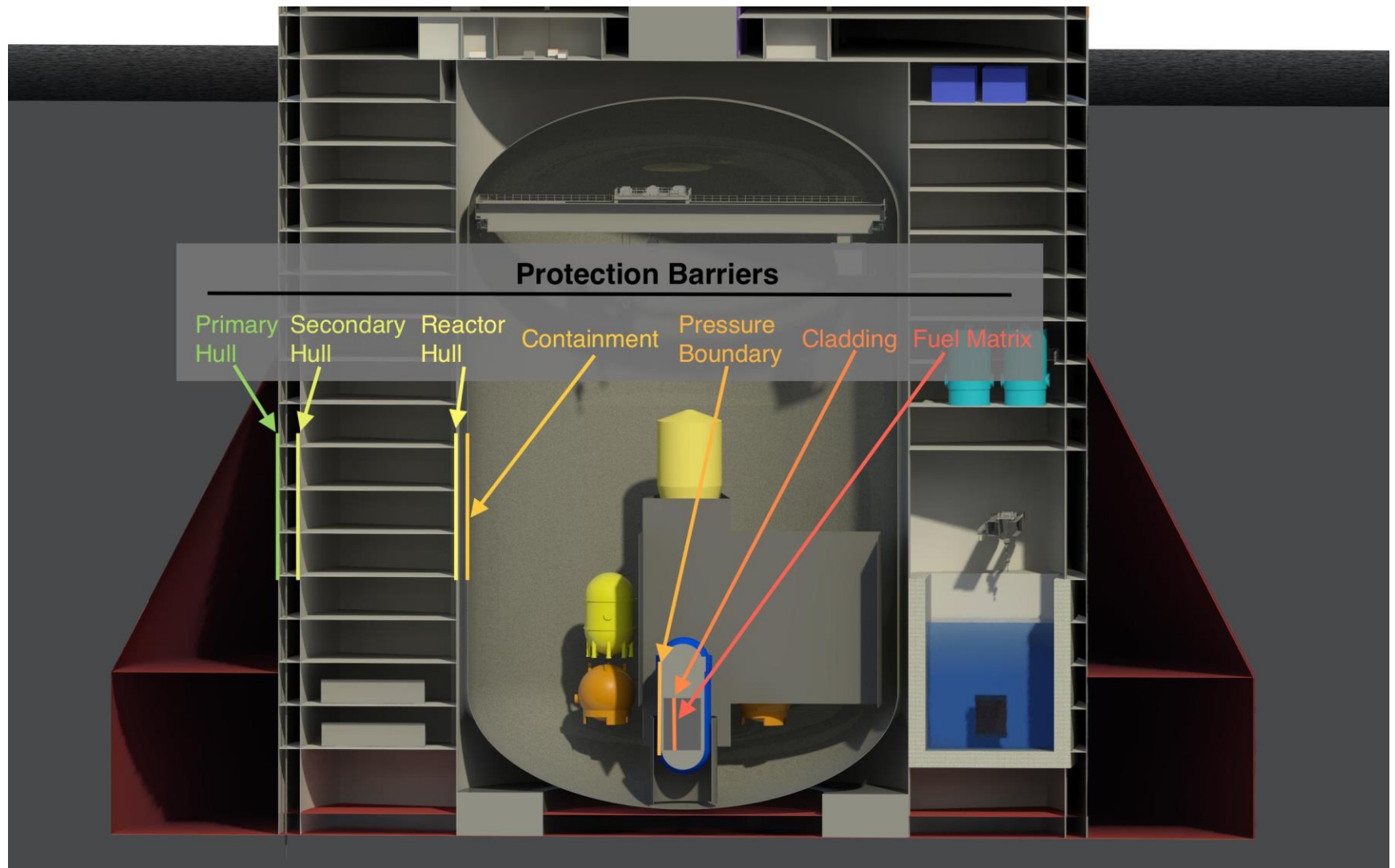

# Designed for Superior Safety

- Ocean-based safety systems **remove decay heat from core and containment passively and indefinitely**
- **Loss of ultimate heat sink is eliminated by design**
- **No need to vent even under severe accident conditions**

Transients (e.g. loss of offsite power, loss of flow)

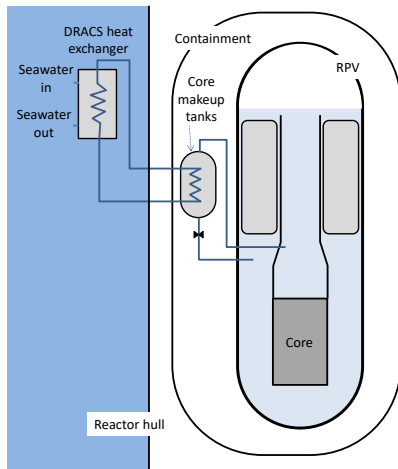

Design-Basis Accidents (e.g. loss of coolant)

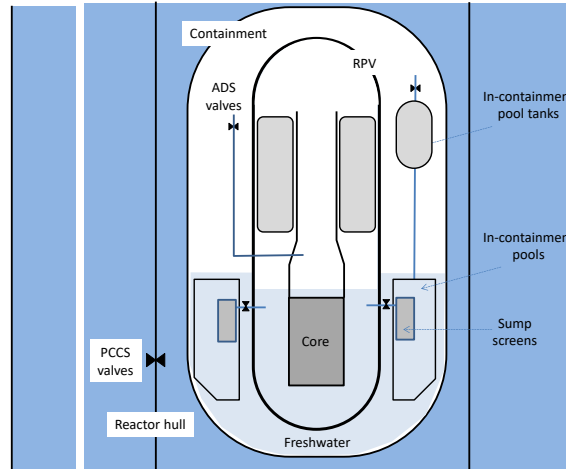

Severe Accidents (e.g. core meltdown)

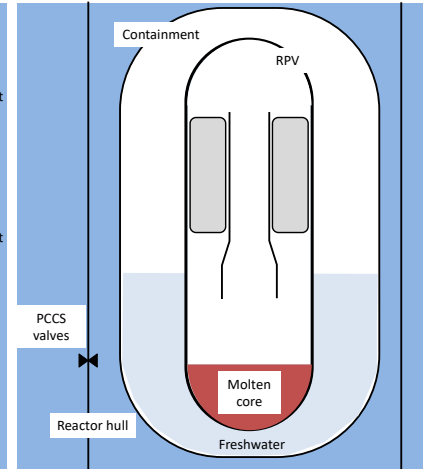

# No Resident Population in Emergency Planning Zone

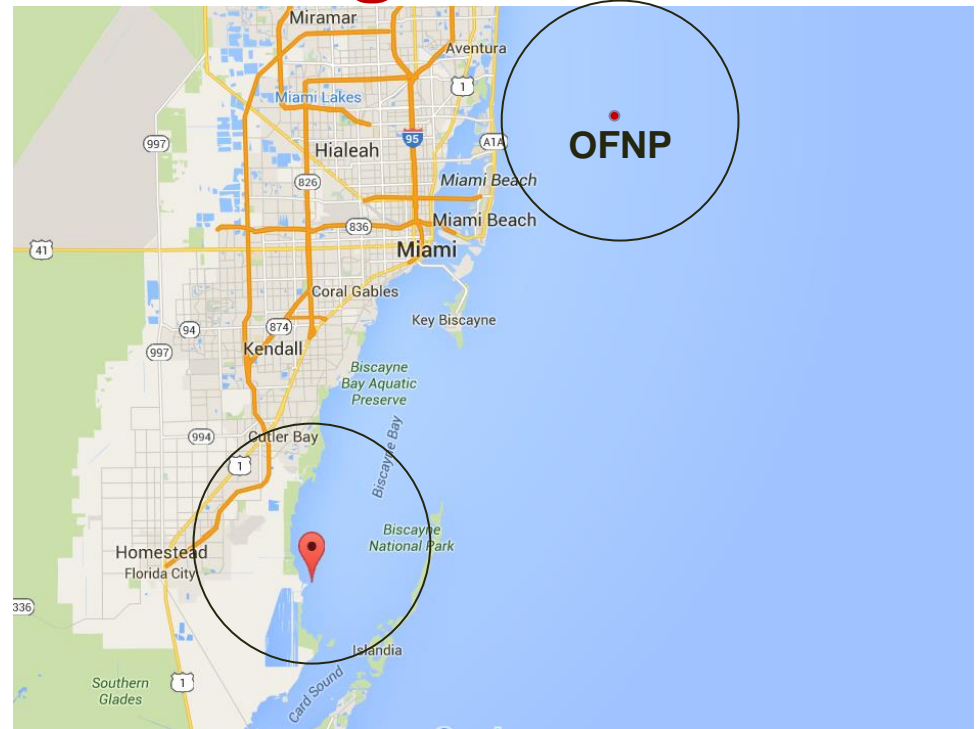

Plant	Population within 16-km radius	Evacuation plan	Distance from major load center
Indian Point	~270,000	Yes	40 km from NYC
OFNP NYC	0	No	<25 km from NYC
Turkey Point	~160,000	Yes	30 km from Miami
OFNP Miami	0	No	<25 km from Miami

# Economic Potential

- Traditional plants: build large reactor at the site; some modularity used to accelerate schedule, not reduce fabrication costs (AP1000 example)
- Small Modular Reactors (SMRs): build many small reactors in a factory; requires expensive dedicated factories to build the modules
- New OFNP cost paradigm combines:
  - Economy of scale: high power rating possible (OFNP-1100)
  - Economy of modules: built in series in *existing* shipyards
  - Lower construction cost: elimination of excavation work, structural concrete, temporary facilities and associated labor



## Nuclear, business as usual

## New model?

	ON LAND	OFFSHORE
<b>Licensing</b>	Site specific (ground and seismic requirements)	Standardized (site-independent design)
<b>Construction</b>	At site + lots of concrete (cost and delays)	In centralized shipyard + <u>structural concrete is virtually eliminated</u>
<b>Ownership and Operations</b>	Domestic utility owns and operates with domestically trained workforce	International utility could own and operate a worldwide fleet of plants, with crews that receive standardized training and operate in semi-monthly shifts (onboard living quarters)
<b>Safety</b>	Passive safety (new plants); evacuation possibly needed in case of severe accident	<u>No loss of heat sink;</u> <u>no earthquake and tsunamis;</u> <u>superior defense in depth;</u> <u>no evacuation needed</u>
<b>Plant lifetime</b>	60 years; all at one site	60 years; <u>can track most profitable markets</u> with minimal local infrastructure (plug-and-play)
<b>Decommissioning</b>	At site (decade-long project)	<u>Immediate return to “green field”;</u> Decommissioning in shipyard

# Plant Construction and Deployment

Robust global supply chain exists for floating platforms and Light Water Reactors



# Plant Construction and Deployment

Could be built vertically,  
- on a skid, or  
- on a barge (and completed afloat) or  
- in a dry dock



# Plant Construction and Deployment

Built vertically on skid, moved to transport ship, and lowered into water



# Plant Construction and Deployment

Moved to transport ship (dry tow, 15-20 km/hr)  
or launched to sea (wet tow, 10 km/hr)



# Key challenges

- **Find suitable sites** ⇒ Nuclear plants should be *near* the coast, but not necessarily *on* the coast



# Market Potential

Top-tier siting requirements:

- Favorable topography, i.e., relatively deep water (~100 m) within territorial waters (<30 km)
- Unavailability or high cost of other modes of energy generation

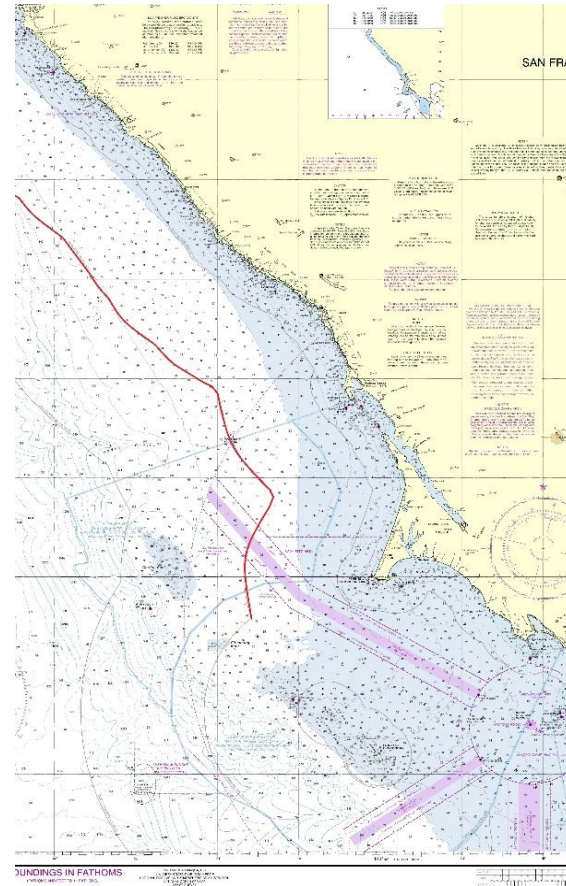
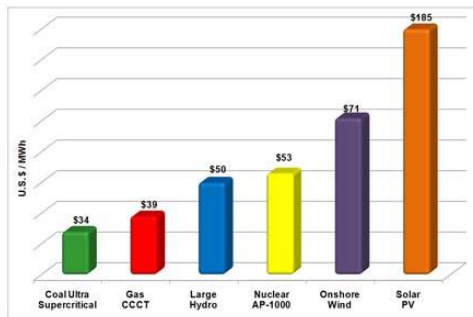

# Market Potential (3)

EAST AND SOUTH-EAST ASIA (high seismicity and tsunami risk, high coastal population density, and limited domestic energy resources)

Japan, Indonesia (oil/gas better exported), South Korea, Vietnam, Malaysia, Philippines, China, India ...

MIDDLE EAST (massive water desalination plants, oil/gas better exported):  
Saudi Arabia, Qatar, Kuwait, UAE, Bahrain, ...

AFRICA AND SOUTH AMERICA (small grids, high prices of electricity, water desalination, no incentives to develop large domestic nuclear infrastructure)

Algeria, Egypt, Nigeria, Tanzania, South Africa, Chile, Argentina, ...

OTHERS (Europe, large mining operations, small island countries, military bases)

U.K., Turkey, France, Spain, Australia, Alaska, Micronesia, large offshore oil/gas operations anywhere, DOD bases, ...



# Future Needs

- Essentially no R&D, but design development
- Investors, Customers
- Stable regulatory environment

END

Back-up slides follow