

Seeing and Measuring at the Nanoscale

Need to start by clarifying what we mean by “seeing”

It generally means collecting information point by point

To do this, the key is to perform some sort of triangulation:

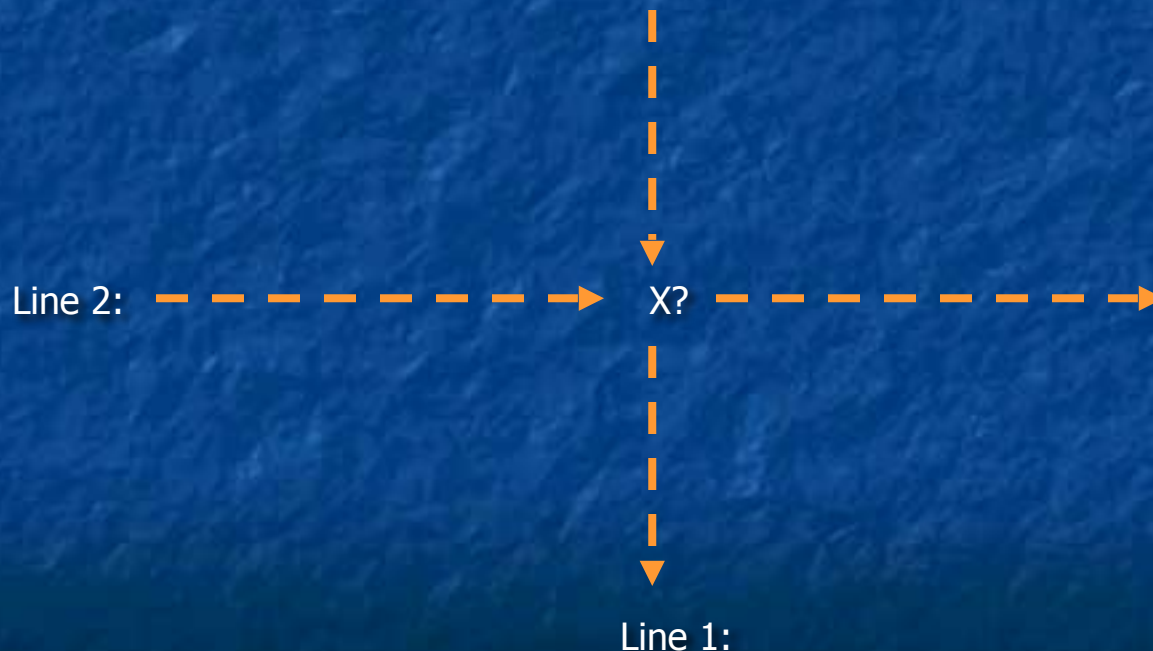

But when I look at things I don't always triangulate!

When things are close, you triangulate by using “binocular vision”

When things are far, you triangulate by inferring surfaces Huh?

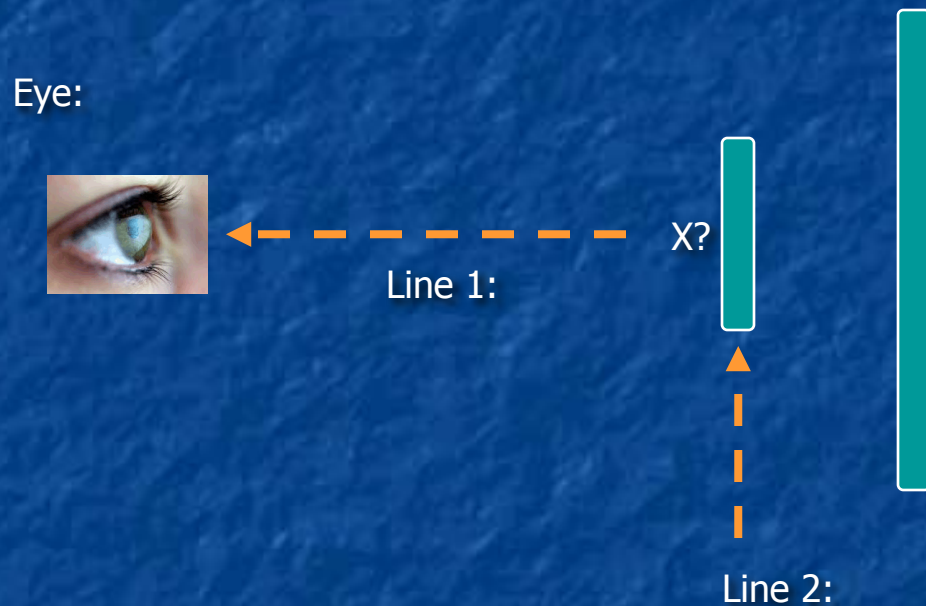

You construct a second triangulation line by inferring which surface the point is on
(Along with the relative distances of different surfaces)

How is that relevant to seeing at the nanoscale?

It's relevant because, at the nanoscale, seeing gets a **lot harder**

And it requires a lot of complex and expensive engineering

So you need to reduce “seeing” to its barest essentials

The essential for triangulation is that you have a well defined **PROBE** and **SIGNAL**:

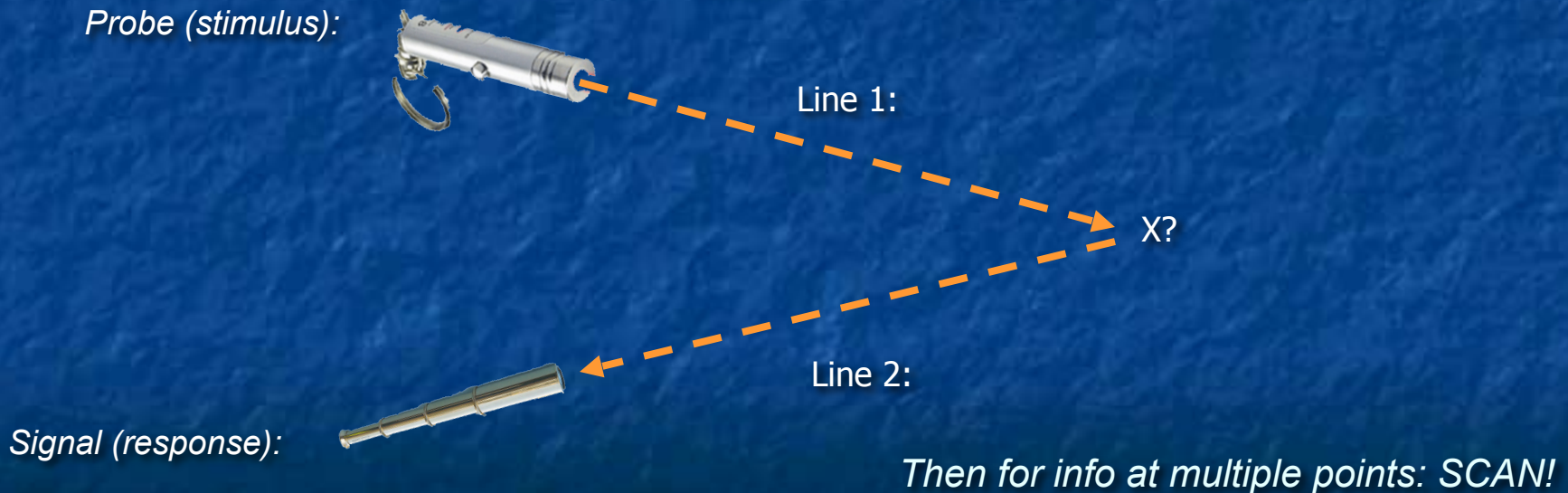

Do BOTH probe & sensor have to be direction sensitive? No!

Non-directional source:

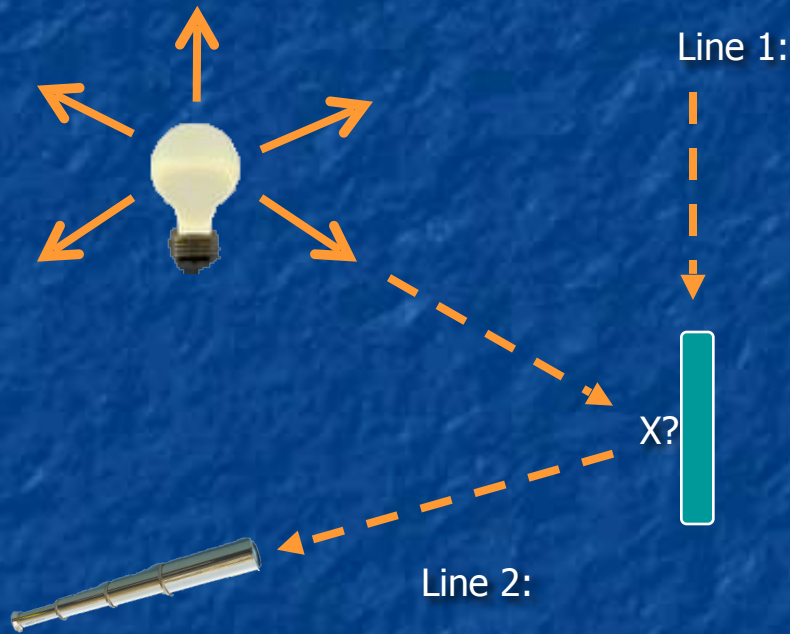

Non-directional sensor:

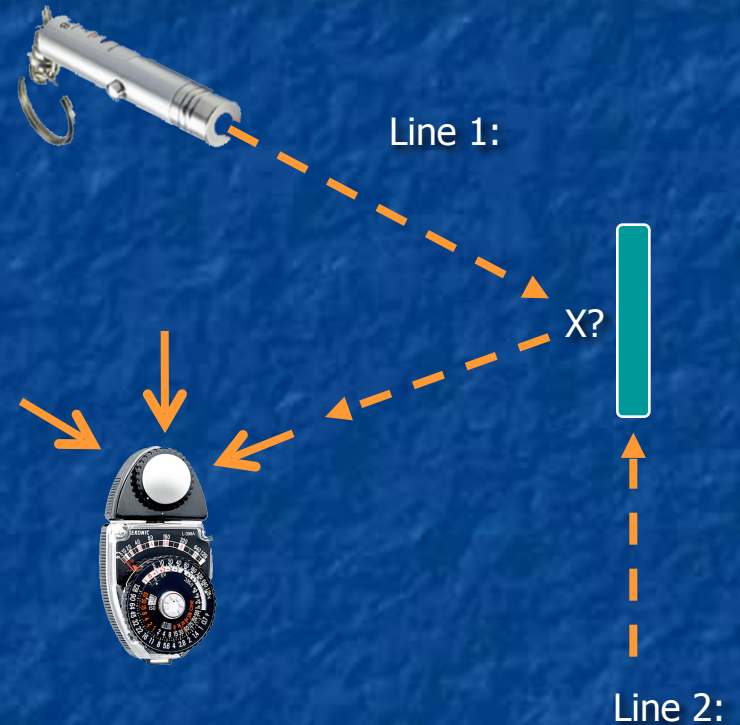

So on surfaces, you can greatly simplify either source or sensor!

But this still seems to rule out use of light at the nanoscale

Because we still need one thing (source OR sensor) to be nano directional

And we know, from lecture 2, that light will not stay confined into nano beam $< \lambda$ wide:

“Diffraction limited focusing”

But there is a trick: Don't give light enough room to spread out:

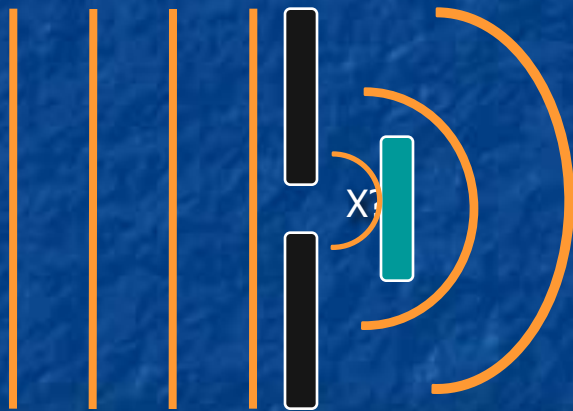

Nanoscale
Aperture

But how do we then see around that bulky aperture?

Use drawn down optical glass fiber:

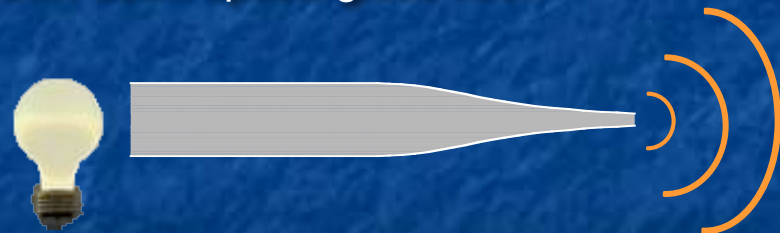

Also works in reverse to sense light for sub λ point

NSOM: Near-Field Scanning Optical Microscopy

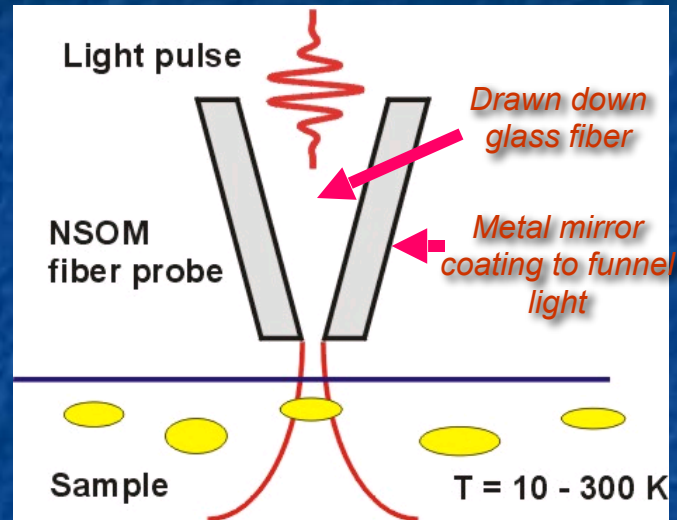
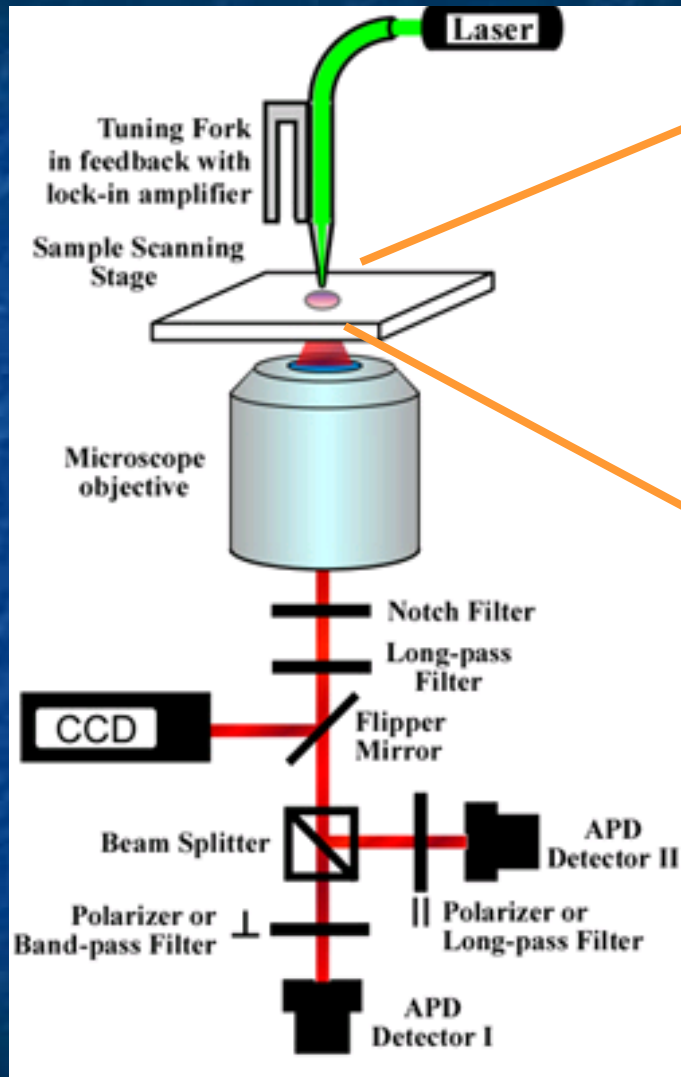

From above: Sub λ wide light from end of fiber

To below: Optics and various light detectors

With exact position determined by:

Surface + X-Y Position of Fiber's End

The 2014 Chemistry Nobel recognized another end run on diffraction:

To Eric Betzig for the Photoactivated Localization Microscope (PALM)

Working in sister department of mine while we were at Bell Labs

Problem: We can put photochemical **tags** at specific locations in cells & molecules

Incoming light can cause tag to emit light of different color (fluoresce)

But light emitted from nanoscopic tag then **blurs** due to diffraction!

Solution: Light from **single tag** will radiate out in **precisely circular waves**

Set up conditions so that only a **few distant** tags radiate **at one time**

Then, their growing circular blobs of light won't overlap (confusing image)

Figure out the **center** of each circular light blob (via computer analysis)

=> **Precise** position of each tag

Subsequent images => positions of other tags => map of cell / molecule

Or as depicted by the Nobel organization:

Figure 4

The principle of single-molecule microscopy

1 A weak light pulse activates a fraction of all the fluorescent proteins. The distance between them is greater than Abbe's diffraction limit of 0.2 micrometres. They glow until bleached, at which point the procedure is repeated on a new subgroup of proteins.

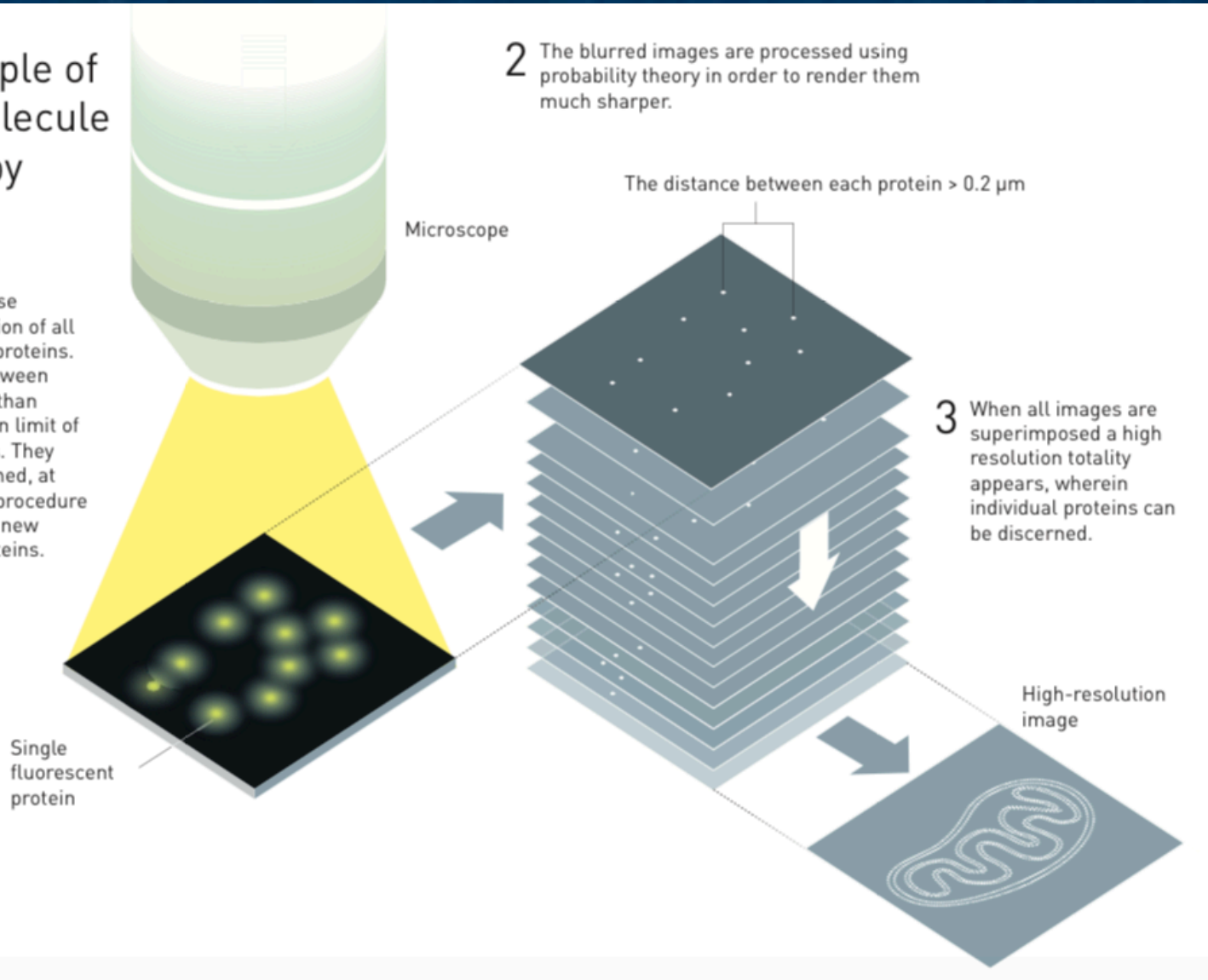

But NSOM & PALM are ~ limit of **all light** seeing. Other ways of nanosize things? Yes:

Scanning Probe Microscopies (SPMs)

Derived from inventions of Binnig & Rohrer, and Quate

Scanning Tunneling: Electrons tunnel between atomically sharp probe and conducting sample

Atomic Force: Nanometer sharp probe rubs or taps along surface of any sample

"DI Dimension 3100" SPM capable of both AFM and STM operation:

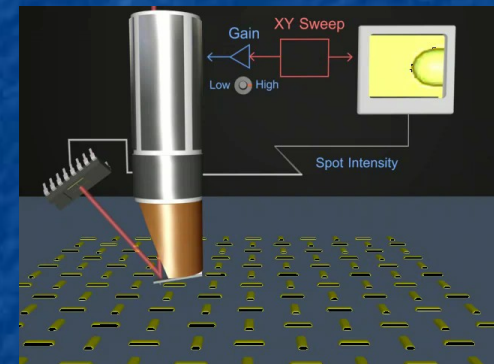
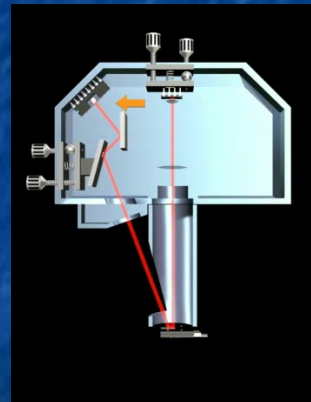
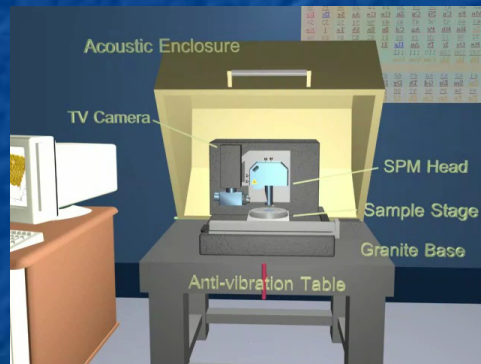

Complete detailed description of instrument's operation and piezoelectric core at:

https://WeCanFigureThisOut.org/VL/SPM_operation.htm

https://WeCanFigureThisOut.org/VL/SPM_piezoelectric.htm

OR the units we've used in this class's lab:

Nanosurf easyScan2 Atomic Force Microscope:

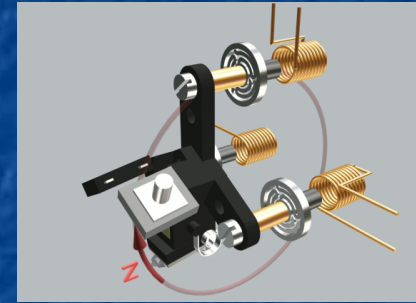
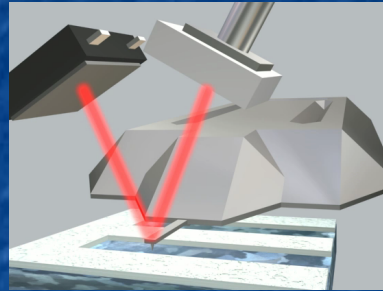
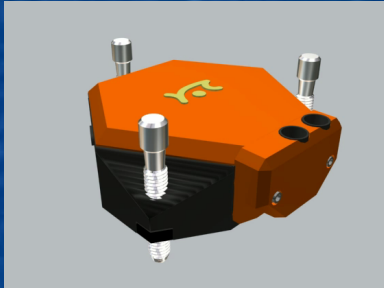

Complete description at: https://WeCanFigureThisOut.org/VL/easyScan_AFM.htm

Nanosurf easyScan2 Scanning Tunneling Microscope:

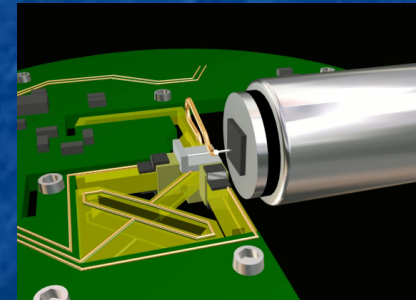
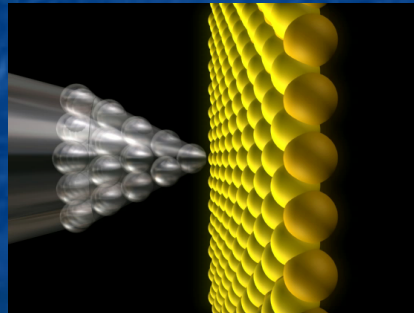
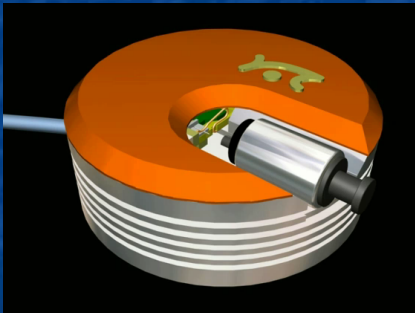

Complete description at: https://WeCanFigureThisOut.org/VL/easyScan_STM.htm

And SPM's can do more than just measure surface shape:

STM: Pulls electrons FROM sample → from FILLED electron orbitals OR:

Pushes electrons INTO sample → to EMPTY electron orbitals

=> Energy levels of surface atoms and molecules

Current from STM or AFM tip is also sensitive to sample's local electrical resistance

=> Concentration maps of electrically active impurities in semiconductors

In alternating current modes, STM and AFM tips can be sensitive to capacitance

=> Maps of electrical impurities and their energy levels

Plus:

MANY, MANY other modes that give information on far more than surface shape!

But probe microscopies have their own limitations:

Ultra-fine probe tips are difficult to make and very easy to damage

So samples need to be **almost** atomically flat

Meaning SPMs **cannot** look at a whole lot of interesting samples!

And even with ultra flat samples, nano probes will STILL get damaged!!

Requiring expensive replacement probes & probe mounting schemes

Besides which:

What if want to sense things **BELOW** surfaces?

What if want to know more than shape (e.g. composition, bonding . . .)?

So it is time to look much farther afield for possible probes and sensors

Start by identifying the full range of potential probes & signals:

- | | |
|--------------------------------------------|-----------------|
| 1) Physical probes (points, needles . . .) | 2) Ions / Atoms |
| 3) Electrons | 4) Photons |

We can design at least (!) one instrument around each of these probes/signals

But that is far too limiting!

Analysis consists of sending something in, and looking at what comes out

STIMULUS AND a **RESPONSE**

Each of the above probes/signals can serve as the STIMULUS

And almost all of the above probes/signals might be part of the RESPONSE

So these generate a whole matrix of possibilities:

Ions in & out: Secondary ion mass spectroscopy (SIMS) . . .

Electrons in & out: Scanning Electron Microscopy (SEM),
Transmission Electron Microscopy (TEM),
Auger electron spectroscopy (AES) . . .

Photons in & out: IR spectroscopy (FTIR), Ellipsometry . . .

Photons in / Electrons out: X-ray and UV photoelectron spectroscopy (XPS, UPS, ESCA)

Electrons in / Photons out: Energy Dispersive Analysis of X-rays (EDAX) . . .

And virtually every other combination imaginable!

With even more variations if you switch to different ranges of energy!

Let's go through stimulus/response possibilities more slowly:

Atoms / Ions: Big and heavy → Not used that much in nanoscience

If we shoot them in, we'll alter (likely destroy) the structure

If they are coming out, we must have already torn apart the nanostructure

Electrons: Small, light, charged

Small and light → Good news: They generally cause minimal damage

Charge → Good news & bad news:

Easy to steer and focus - Just need electric field between metal plates

But don't play well with insulating samples

Shoot them in → Insulator charges up negative

If with more than ~ 10 eV → kicks out "secondary electrons"

Charging → Electric fields → Complicates counting and measurement of energies

And size of electron or electron-beam can get tricky:

Individual electrons have variable size defined by Quantum Mechanical wavelength:

$$\lambda_{\text{de Broglie}} = \text{Plank's constant} / \text{Electron's momentum} = h / \sqrt{(2 m E)}$$

And a small BEAM of multiple electrons will spontaneously get wider:

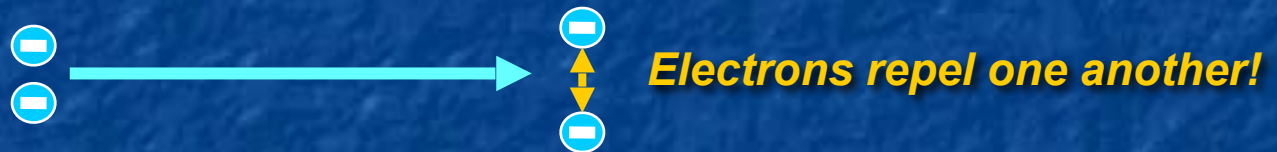

Solution? Fast high energy electrons are smaller

Fast high energy electron beams stay narrow over longer distances

But there is a downside: High energy → Long penetration

Electrons in: Stimulate signals from large volumes and depths

Electrons out: Collected from large volumes and depths

Approximate numbers?

For electrons entering or leaving solid matter:

Electron Energy	Penetration / Escape Depth	Limit to resolution:
1-5 keV	tenths of nanometers	1) Minimum e-beam width 2) Electron size (wavelength) Microns to 10's of nanometers ¹
10-50 keV	nanometers	1-10 nanometer ¹
100 -1000 keV	tenths of MICRONS	tenths - hundredths of nanometers ²

Or schematically showing incoming + outgoing beams, and volume probed:

Low electron energy:

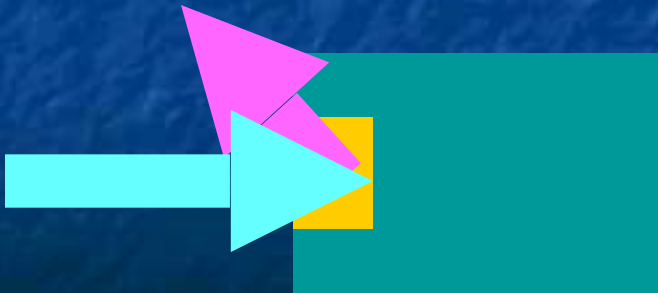

High electron energy:

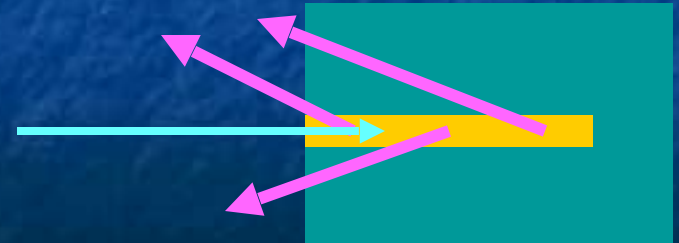

Opportunity for narrow high energy electron beams:

Beams can penetrate far but are very narrow

Use to sense things that are essentially in columns along the incoming beam direction:

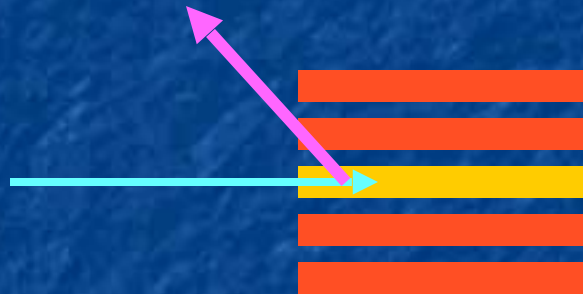

Scan beam across sample

Narrow beam distinguishes between different columns

Where to find such configurations in nature? Crystals!

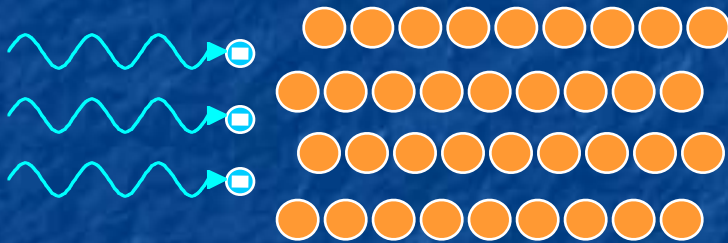

"Atomic resolution" image from my research on growth of GeSi on Si

= Basis for Transmission electron Microscopy (TEM)

Transmission electron microscopy:

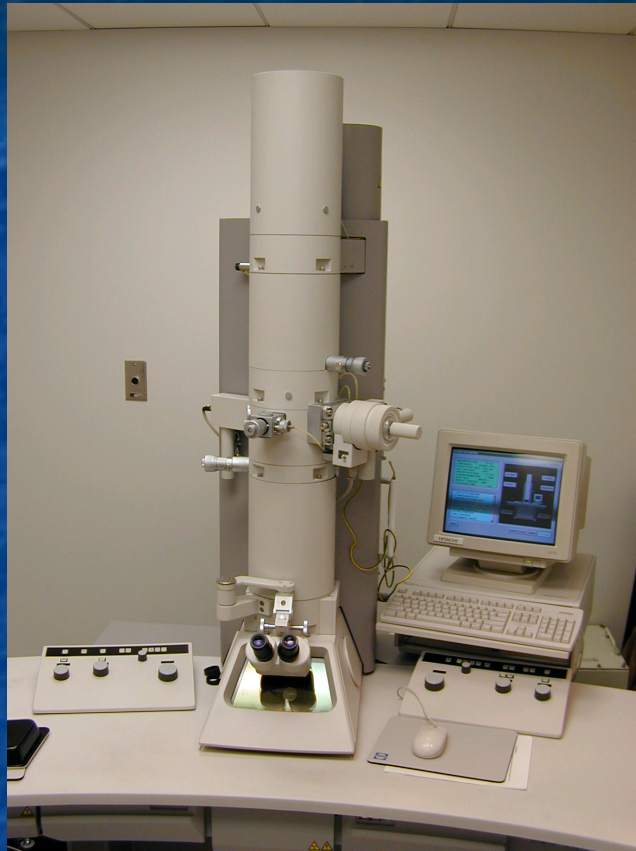

Left: www.biotech.unl.edu/microscopy/TEM.htm

Right: www.uiowa.edu/~cemrf/methodology/tem/index2.htm

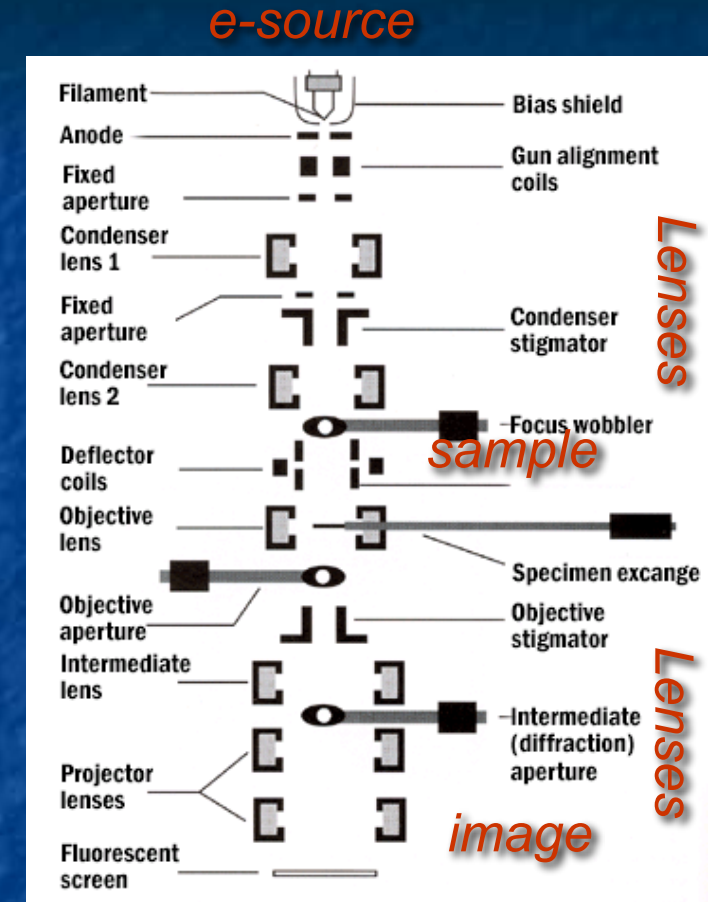

But TEM only has pseudo atomic resolution = End on views of atom COLUMNS

While useful for semiconductor crystals - Not that useful for 3D nanostructures!

A way of using the fat low energy electrons?

Yes, in combination with skinny high energy electrons / electron beams

Most popular alternative is to use high E stimulus beam + low E response beam

Stimulate using narrow high E electrons:

Sense only low E electrons emerging from ~ surface

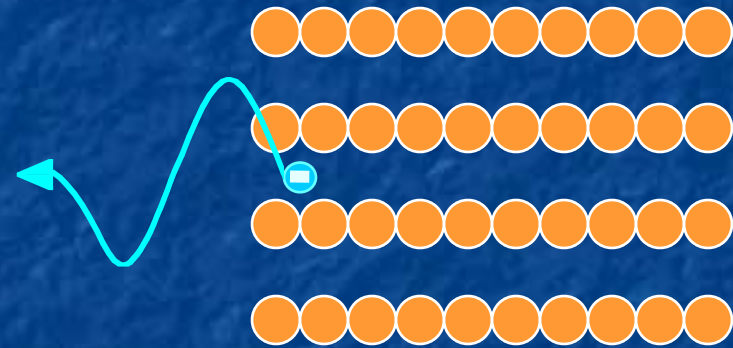
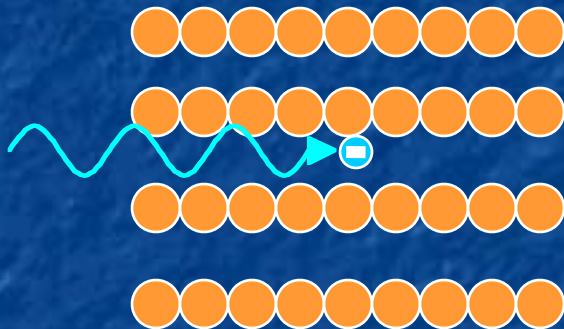

Intersection of stimulus and response volumes = Small 3D volume produces the data!



Scanning Electron Microscopy (SEM):

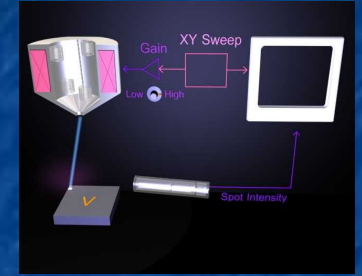
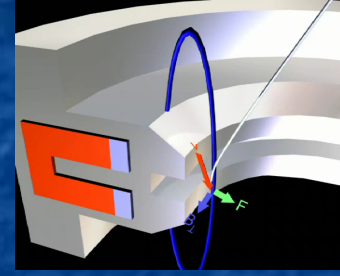

(From <https://WeCanFigureThisOut.org/VL/SEM.htm>)

Incoming electrons $\sim 5 \text{ keV}$ \Rightarrow moderately narrow / moderately deep penetration

Outgoing electrons \sim few eV or less \Rightarrow liberated from top couple of atomic layers

But X-rays that are ALSO stimulated and give information on sample composition

This requires add-on sensor called "EDAX" - Energy dispersive analysis of X-rays

What about photons used ONLY for probe or signal?

GOOD NEWS: They cause ~ no damage (unless very high energy, e.g. **UV**)

BAD NEWS: They are BIG

Width: Diffraction means we can only focus down to beam ~ one wavelength wide

=> Stimulate / collect signal from areas 1000's of atoms wide (like low E electrons!)

Depth: Photon penetration/escape depends on material and wavelength

METALS: Almost zero penetration/escape depth with highly conductive samples

But also almost zero information out (as beam reflects ~ unchanged)

NON-METALS: Penetration/escape depths = wavelength to many wavelengths

So see cumulative effects of hundreds-thousands of layers

Thus combine light with another probe or signal

Alternative #1)

Send photons in: Penetrate and stimulate 100's-1000's of atom planes deep

Sense electrons out: Kicked out by photon energy (eV's to keV's)

These electrons can only escape from first **few atomic layers!**

Alternative #2)

Send electrons in: If limit energies to few keV, can only penetrate **few atomic layers**

Sense photons out: Those stimulated by the incoming electrons

Either way, only collect information about the first few atomic layers!

But we need to know more about how photons & electrons interact with atoms:

Goes back to atomic energy levels (electron standing waves in funny box):

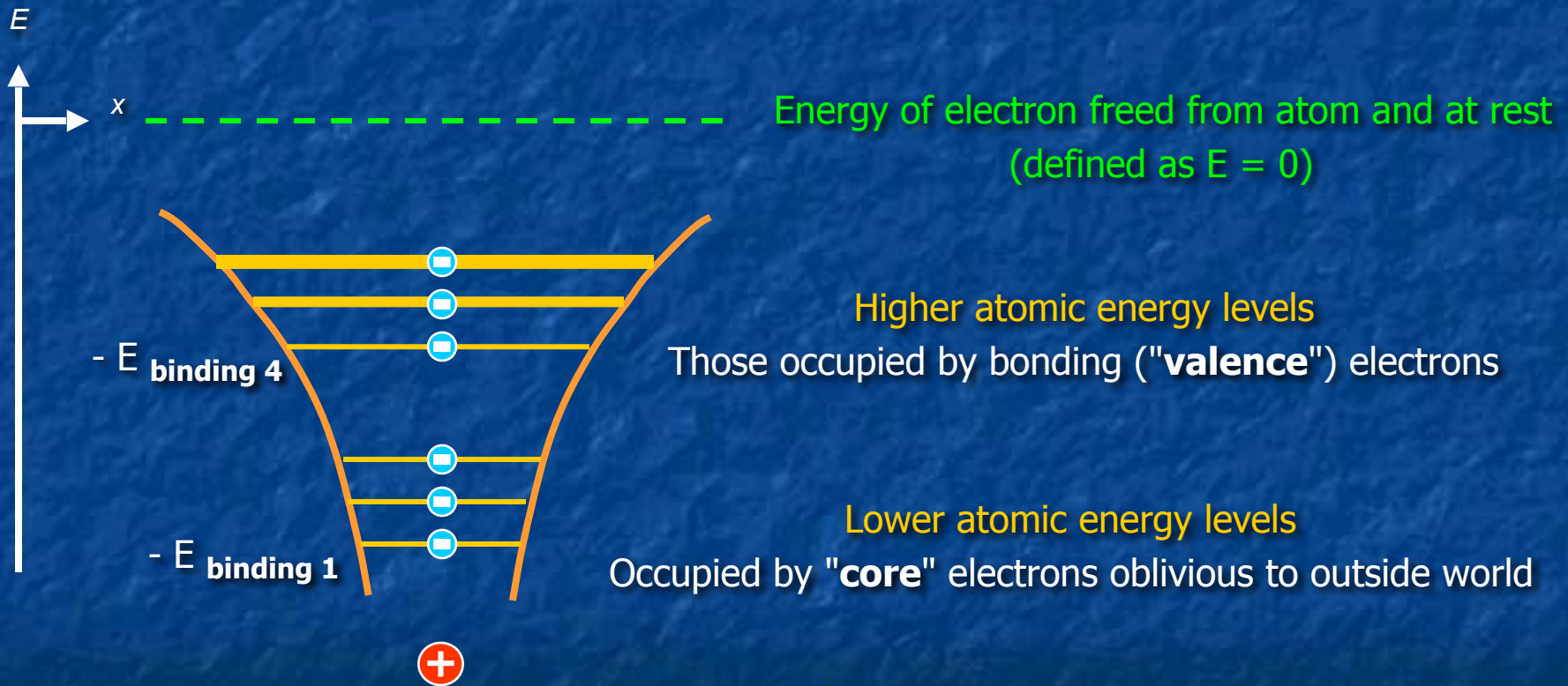

Now send in a photon or electron to knock out **core** electron

Simplest conversion of energy: Assume ALL of incoming energy is absorbed

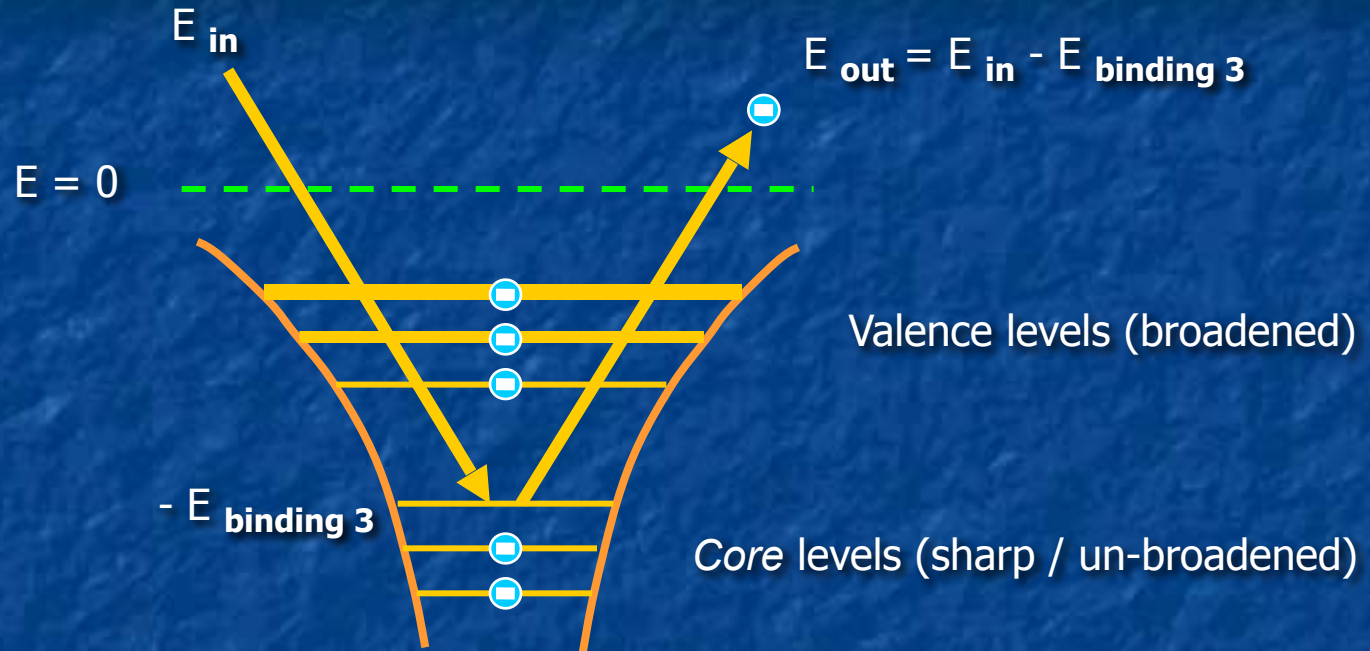

Core energy levels are unique to each atom and unaffected by bonding:

If you know precise E_{in} can calculate core energy levels from E_{out}

Gives you the chemical identity (and approx. concentration) of atoms probed

Measured over depth of few atom layers because only those electrons can escape

Different information for different ejected electron energies:

Core electron levels were unaffected by neighboring atoms

Gave unambiguous ID of originating atom - but nothing about what it is bonded to

So use this when you need to know what atoms sample is made of

Valence electron levels ARE changed significantly by neighbors

This blurs the ID of the originating atom - but can give REALLY good bonding info

So use when you know atoms in sample but want to learn their arrangement

Or between these extremes medium electron levels are slightly changed by neighbors

This provides slightly ambiguous ID of originating atoms + some bonding info

How do you select? By choosing energy of INCOMING photon or electron:

keV ejects ALL

(use electrons)

10 eV ejects medium

(use electrons or X-rays)

Few eV ejects only valence

(use UV or visible light)

Particularly precise and instrumentally simple technique:

Auger Electron Spectroscopy

Involves electrons in + electrons out. But process incorporates a subtle twist:

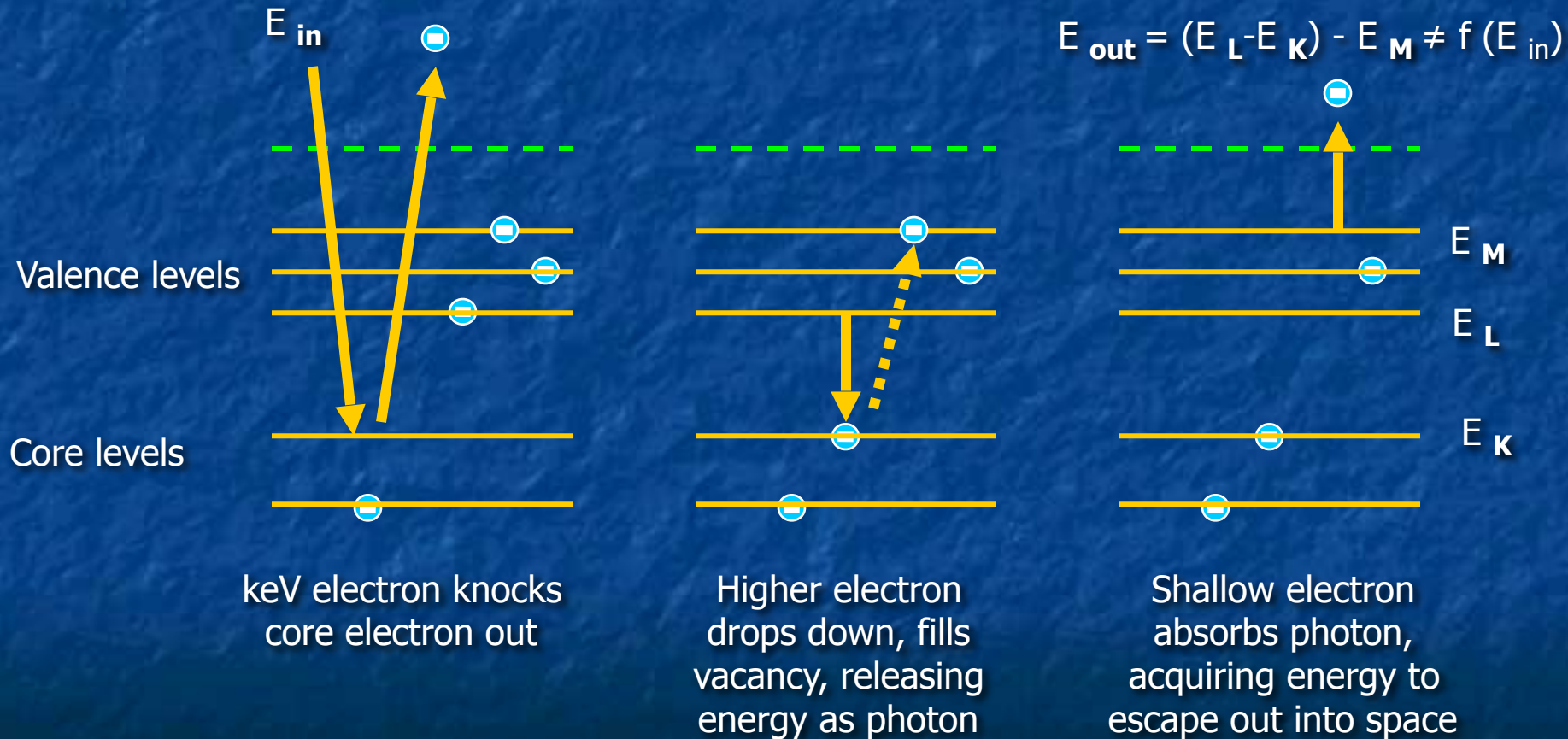

Thus Auger spectrometer identifies atoms very simply:

Can use any old electron source (no need to carefully control incoming energy!)

Can easily measure energy of emitted electrons by how they bend in electric field

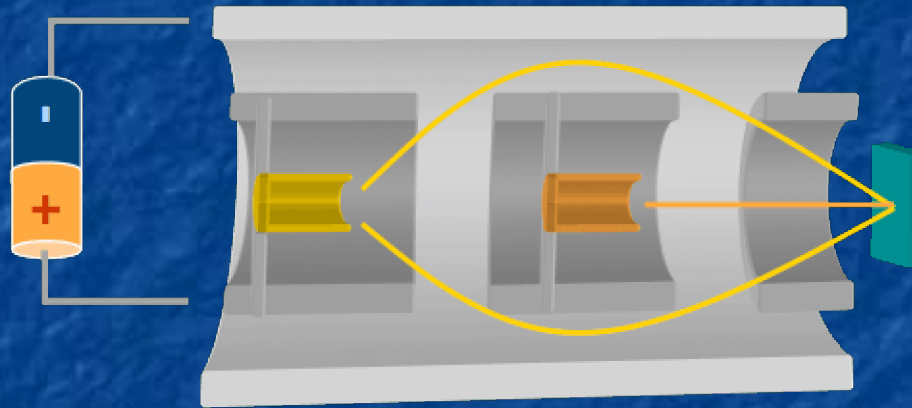

Electrons shoot from electron gun at center (orange), into sample (green)

To reach detector (yellow), ejected electrons must negotiate maze (thru cylinder gaps)

For given set of voltages, only electrons of one energy can do this

Or more schematically:

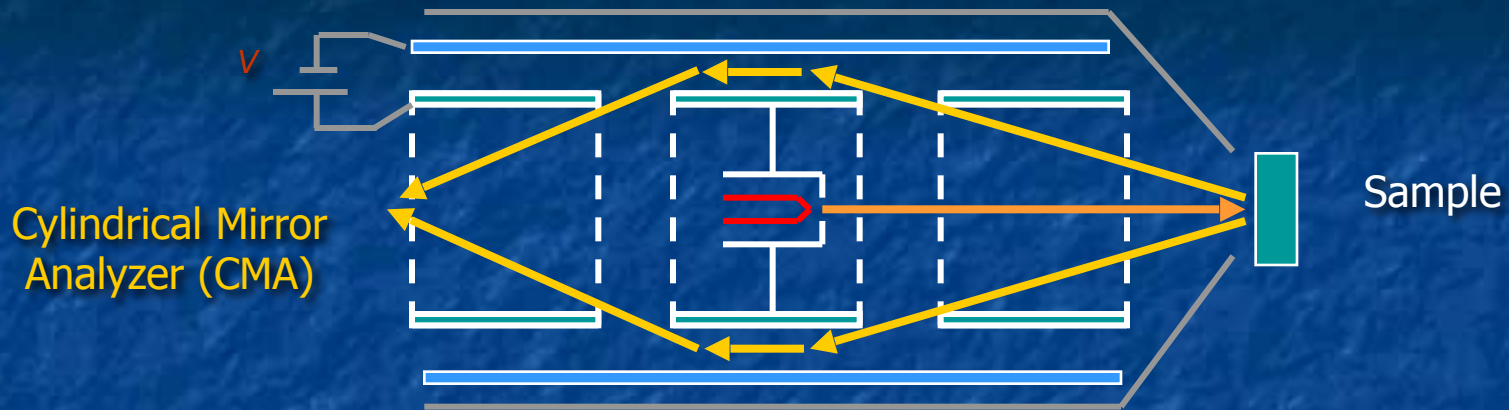

Three concentric grounded cylinders inside long negative cylinder

Cheap electron gun inside second cylinder shooting at sample

Some electrons emitted from sample pass through cylinder-1 / cylinder-2 gap

Voltage on long outer cylinder selects which bend enough to make through following gap

Where are counted (V then scanned to change electron energy \rightarrow spectrum)

Sometime problem in nano-AES analysis: damage

Incoming electrons ~ keV in energy: Energy/charge can damage nano-samples

So switch to lower energy PHOTON beam to only knock electrons out

Good News: Knocks out “shallow” valence electrons → chemical + bonding info

Bad News: Outgoing energy IS ONCE AGAIN function of incoming energy

No longer using tricky Auger energy exchange process

Just transferring incoming photon energy to outgoing electron

To precisely determine atomic energy levels → Must use extremely well defined E_{in}

NEED 2 SPECTROMETERS! One to filter incoming photon energy!

One to filter outgoing electron energy

Instrument's name then depends on photon energy:

Ultraviolet photoelectron spectroscopy (UPS): UV in, very shallow electrons out

X-ray photoelectron spectroscopy (XPS): X-rays in, medium shallow electrons out

XPS (a.k.a. "ESCA" - Electron Spectroscopy for Chemical Analysis) often preferred:

Medium shallow electrons →

Can still identify atomic source

+ get some bonding info

But instrument is now quite complex:

This figure (and ones to follow)
courtesy of Guy Messenger,
ULVAC-PHI Inc.

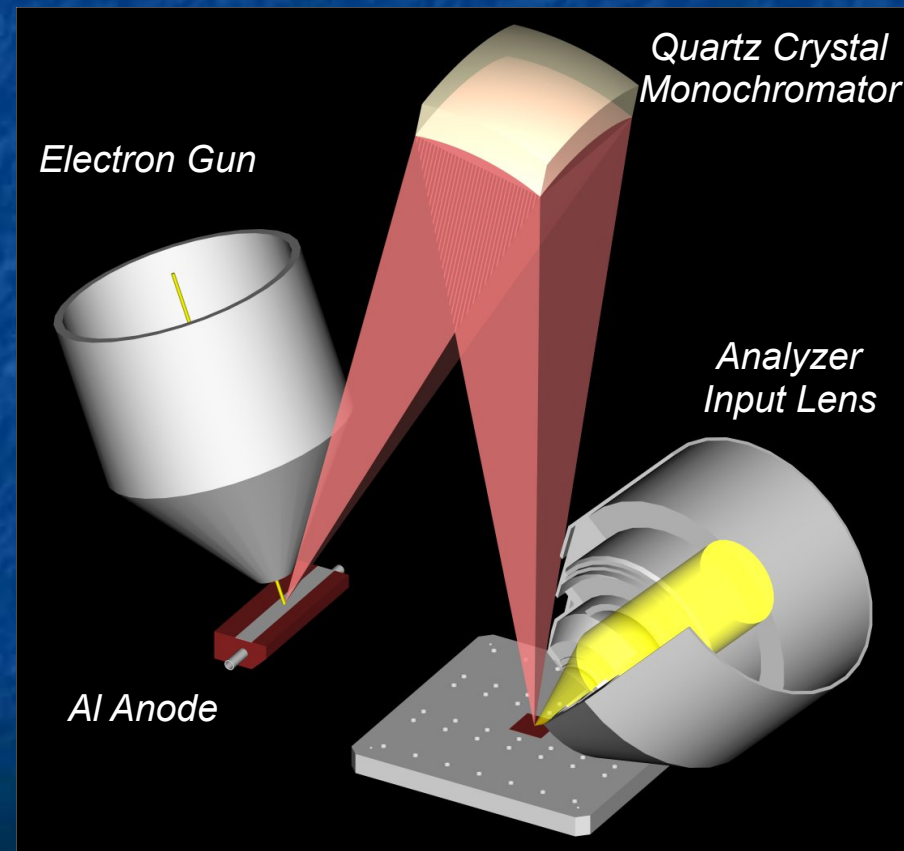

Taking XPS apart piece by piece:

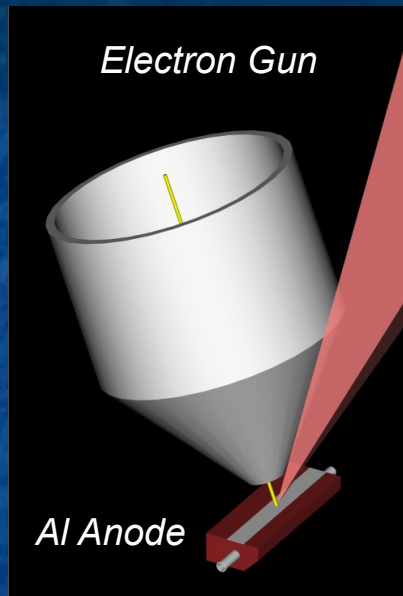

High energy electron beam → Aluminum Anode

= Common way of producing "K- α " X-rays

But X-rays span energy range - So they are then filtered:

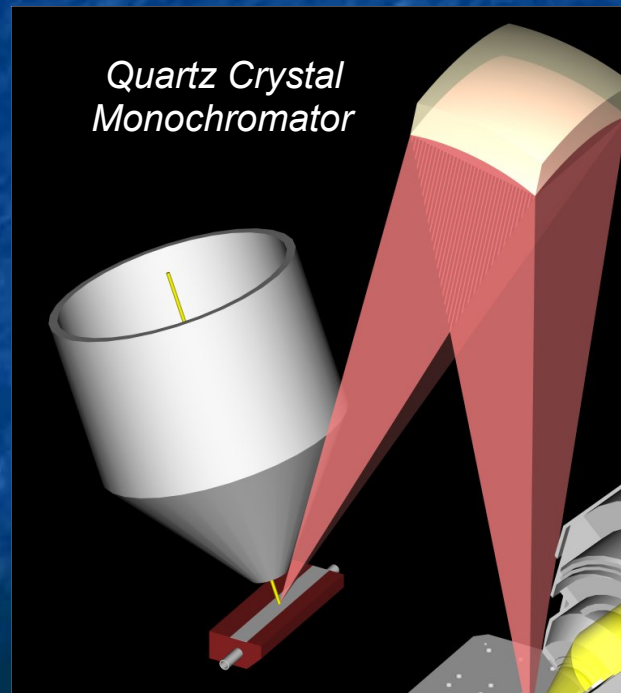

Periodic atomic structure of Quartz crystal reflects only certain X-ray

$$\lambda = 0.83386 \text{ nm} \rightarrow 1.5867 \text{ keV}$$

Mirror is curved to focus those reflected X-rays onto sample:

(Source: ULVAC-PHI)

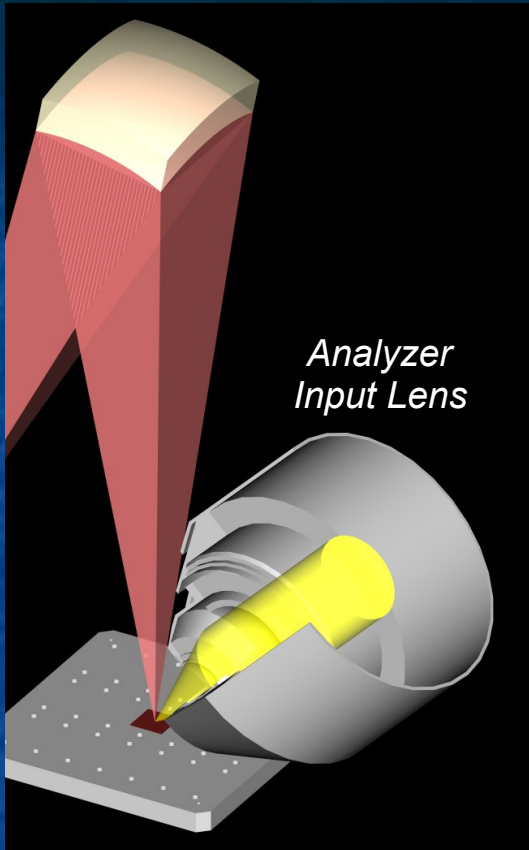

(Source: ULVAC-PHI)

Where focused X-ray beam (pink)

Creates electrons (yellow)

Which are analyzed by passing through electric fields

(Same idea but slightly different geometry than Auger CMA)

X-ray spot size on sample \sim 10 microns (over which area the info is averaged)

But that beam can then be scanned over larger area of sample:

And now it really gets interesting:

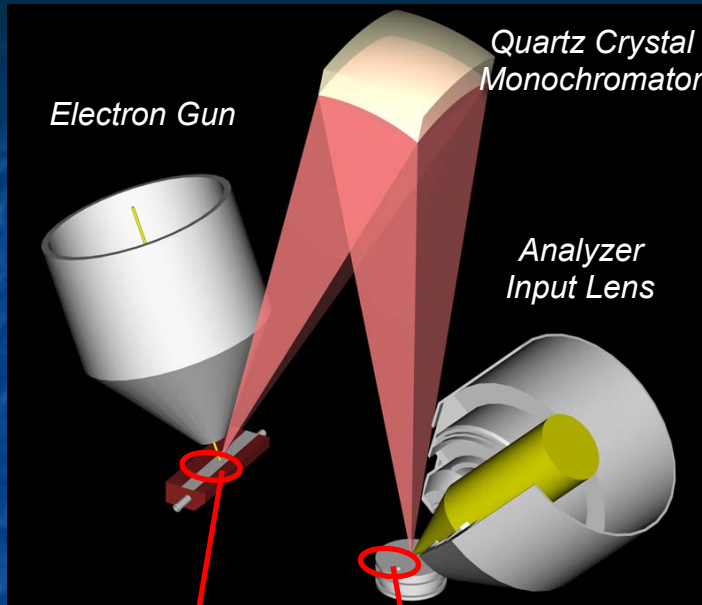

- 1) *Electron beam raster scans across Al anode*
Creates raster scanned spot of emitted X-rays

- 2) *X-ray beam from changing spot reflects off Quartz crystal at changing angle*

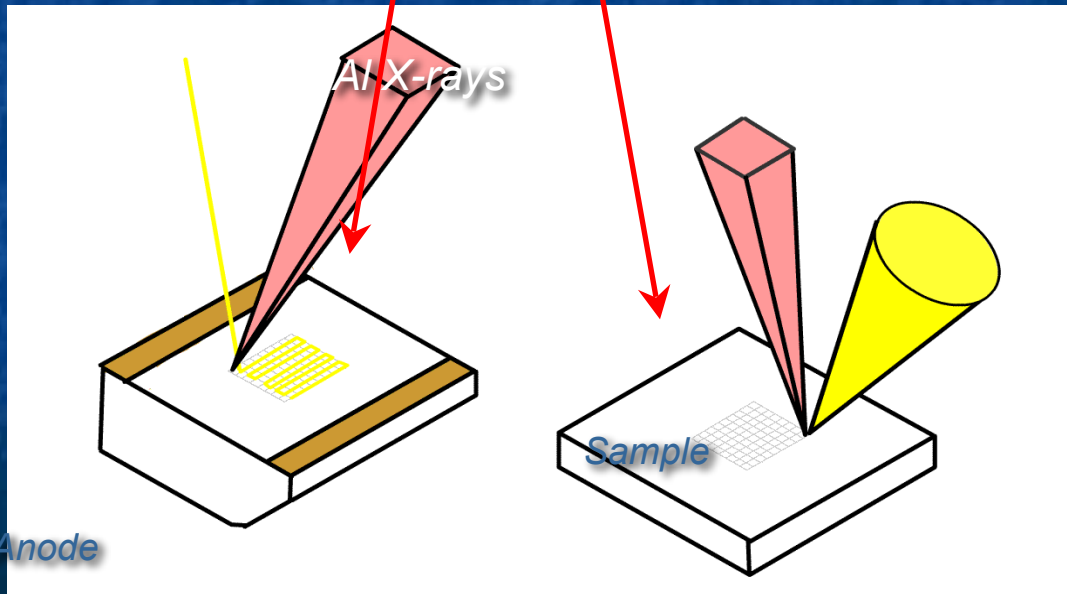

- 3) *Which produces single energy X-ray beam that raster scans across sample*

- 4) *Yielding electrons whose energy is analyzed*

(Source: ULVAC-PHI)

But resulting XPS instrument requires a lot of hardware:

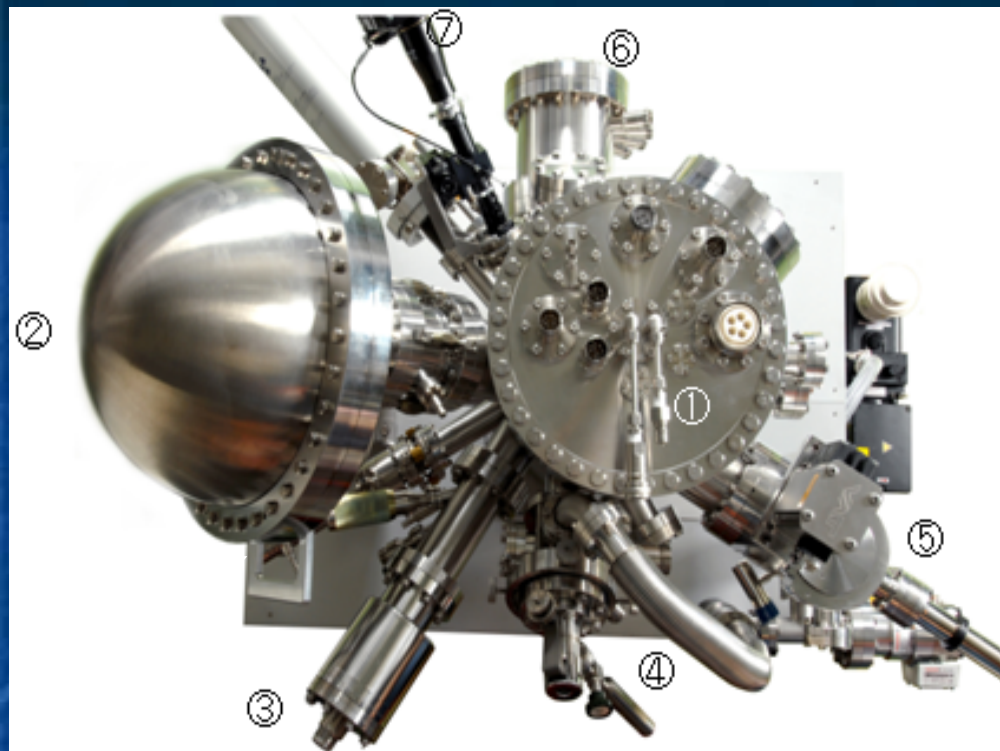

(Source: ULVAC-PHI)

Vacuum Chamber Configuration

1. Scanning X-ray source
2. Electron energy analyzer
3. Optional C₆₀ sputter ion gun
4. Argon sputter ion gun
5. Sample introduction chamber
6. Five axis automated sample manipulator
7. Optical microscope
8. Optional dual anode x-ray source
9. Optional UV light source for UPS

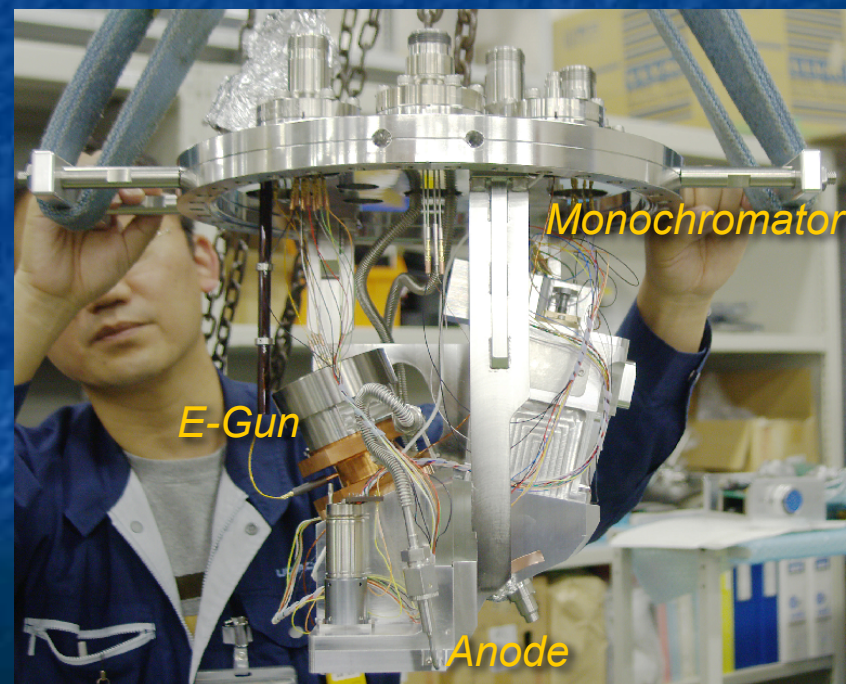

A seemingly big problem with all of those spectroscopies:

What happened to the required triangulations to get precise positions?

It was lost because either probe or response beam was too broad!!!

Yes, but we can partially make up for that:

In addition to telling you what atoms a sample is made of

spectroscopies using valence/near-valence electrons also give **bonding**

From known bonding, you can begin to construct the overall structure:

Si's are bonded to O, O's is bonded to H

At least, should work for fairly simple nanostructures

DIFFICULT, yes, but it's how most nanostructures were originally determined!

OK, but something still seems to be missing!

I've shown techniques for measuring nano things on surfaces

I've shown how to measure nanoscale composition & bonding of samples

But how do you figure out the structure of very complex nano things?

How were things like THIS figured out

(i.e. DNA & proteins)?

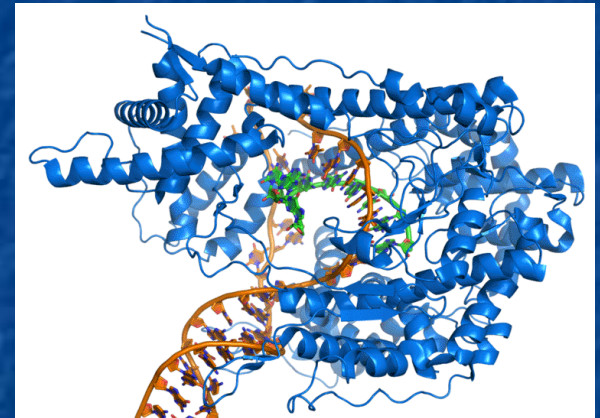

Essential techniques are: **X-ray and electron diffraction**

Tricky to explain, very difficult to interpret

But, in the right hands, they can be golden

They exploit wave nature of both X-rays and electrons:

From lecture 2, every position on a wave acts like a vibrating point

Producing expanding circular waves

When points are in line & in phase, sum of circles => plane wave

Waves from vibrations at one point => vibrations (+ waves) from adjacent points

That's getting a bit complicated – We need an intuitive example:

Remember my rule that “a wave is wave is a wave”

So imagine loud sound causing bell to ring:



So watch as wave progresses by one bell:

Pulse of sound:

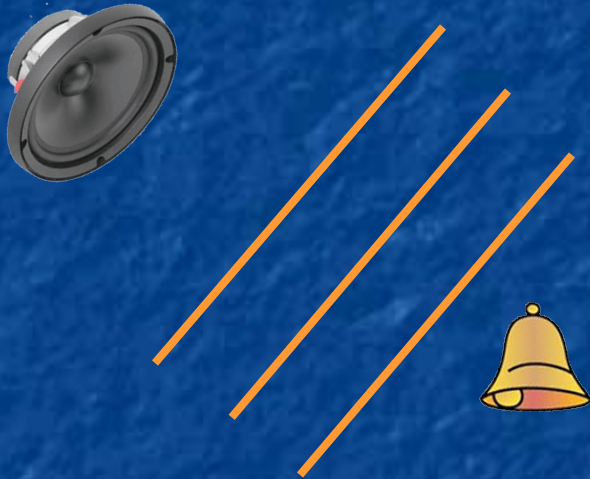

Now past the bell, causing it to ring:

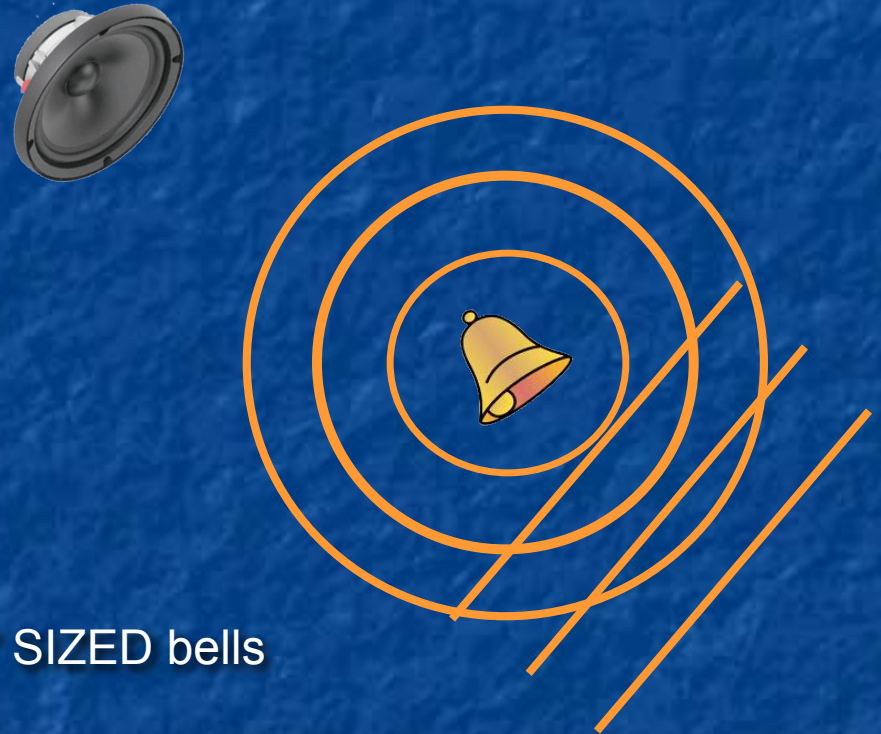

Now imagine a GROUP of DIFFERENTLY SIZED bells

(different size bells = different atoms of a molecule):

It induces “sympathetic” ringing in those bells:

Result of speaker sending out single pulse of sound a little while ago:

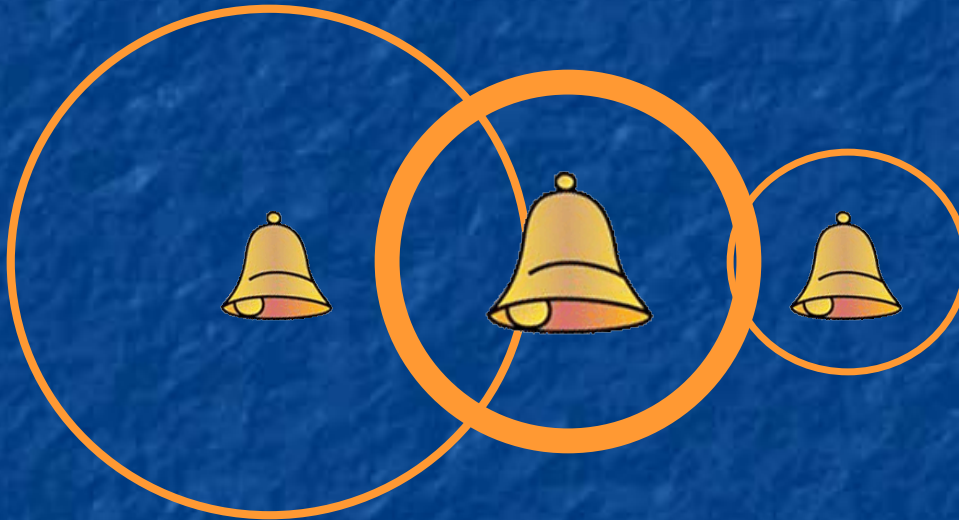

Then apply “principle of superposition” to add separate waves => Scattered wave

Different arrangements / different size bells => Different net scattered wave!

Challenges with such diffraction techniques:

1) Induced “ringing of bells” is likely to be very weak => very weak total signal

Solution: Use regular repetitions of groupings = CRYSTAL of molecules

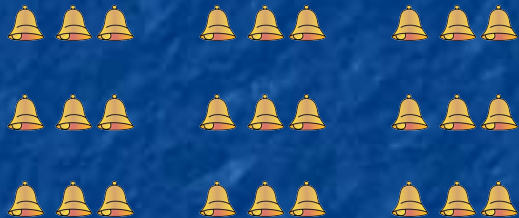

Getting those complex organic molecules to crystallize is thus a critical (difficult) first step!

2) INVERSE PROBLEM: Known grouping => Calculation of net diffracted signal

But from measured diffracted signal, can you figure out the grouping?

Sub-question a) Do different groupings produce unique signals?

Mathcad simulations of wave striking different groupings

Wave, rotating slowly around, striking three different groupings of bells / atoms:



Single frame from movie:

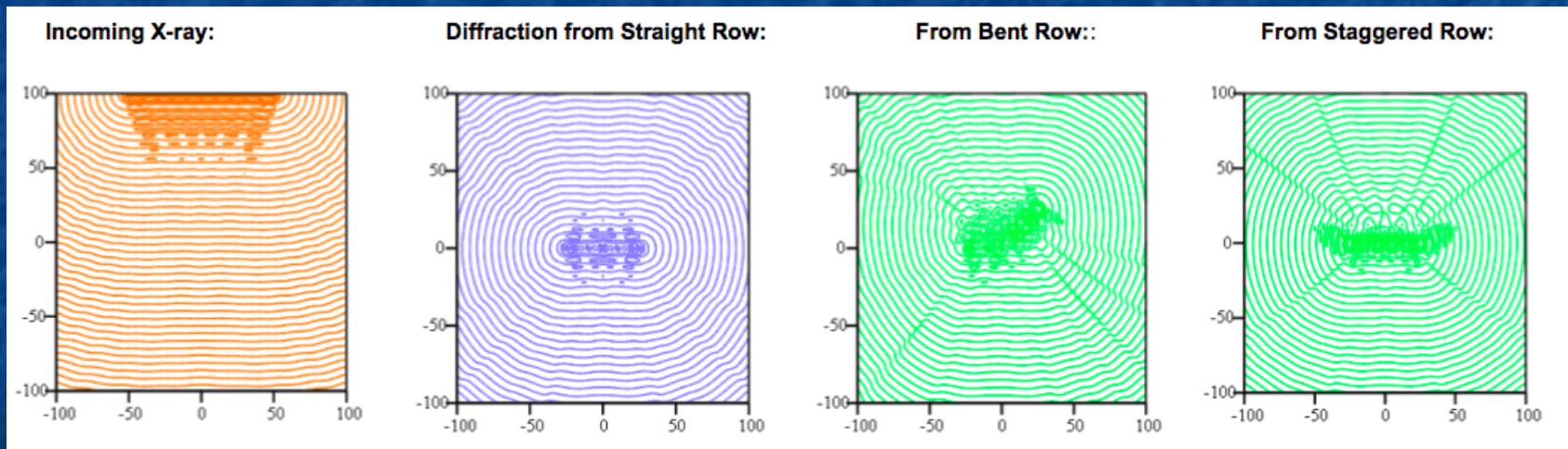

Link to full animation embedded in webpage: [Seeing at the Nanoscale - Supporting Materials - Simulation](#)

So subtly different arrangements DO produce unique diffraction!

Sub-question b) From unique patterns, can you infer responsible arrangements?

There is no well defined mathematical approach for converting pattern to structure

It instead requires first making very good guesses . . . plus a huge amount of work!

Confirmation of this difficulty?

Interpretation of X-ray data to define
this structure => 2006 Nobel Prize

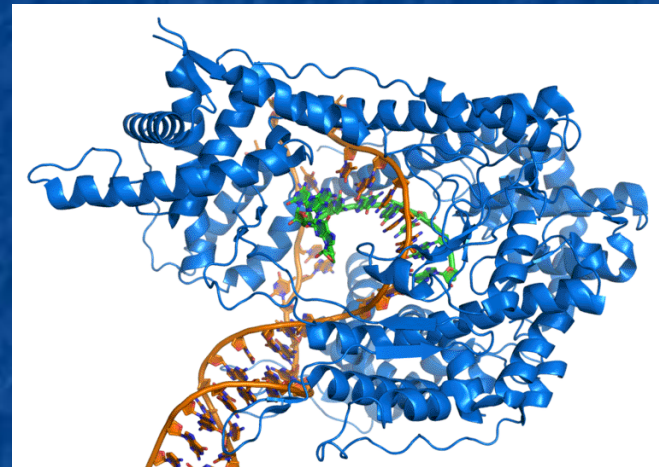

RNA Polymerase (blue) acting on DNA (gold)

(figure from Wikipedia)

In Summary: "Seeing" at the nanoscale is VERY challenging

We seldom obtain easy images as we see them in our daily lives

Instead we are often reduced to feeling our way along nano-point by nano-point

OR

Triangulating & scanning (employing directional sources AND/OR signals)

OR

Inferring structure from spectroscopies that identify atoms & their bonding

OR

Tour de force interpretation of signals such as X-ray or electron diffraction

Nevertheless, now have tremendously detailed knowledge of nano-structures!

Credits / Acknowledgements

Funding for this class was obtained from the National Science Foundation (under their Nanoscience Undergraduate Education program).

This set of notes was authored by John C. Bean who also created all figures not explicitly credited above.

Copyright John C. Bean

(However, permission is granted for use by individual instructors in non-profit academic institutions)